



Dr. Vasanttraodada Patil Shetkari Shikshan Mandal

PADMABHOOSHAN VASANTRAODADA PATIL INSTITUTE OF
TECHNOLOGY , BUDHGAON- 416304

INSTRUMENTATION ENGINEERING DEPARTMENT

DEGREE PROGRAMME: A. Y. 2022 – 23

INDUSTRIAL TRAINING (B.Tech Instrumentation)

SUMMARY CHART

Sr. No.	Name of the company	Number of students
1	Orbit Solutions, Sangli	5
2	Shanti Engineers, MIDC Shirol	1
3	Ganlaxmi Industries, Sangli	9
4	Artisan Technologies	1
5	Intershala Training	1
6	IND- IoT Automation LLP, Sangli	2
7	IOSCAPE (Edge sensing & Cloud Control)	1
8	Pragati Industries, Sangli	2
9	Hem Electroniques, Industrial Area Miraj	4
10	DSD Security Services Sangli	1
11	Vapco Engineers Pvt. Ltd. Belapur	1
12	J Mechatronics, Kolhapur	1



Dr. Vasanttraodada Patil Shetkari Shikshan Mandal

PADMABHOOSHAN VASANTRAODADA PATIL INSTITUTE OF
TECHNOLOGY, BUDHGAON- 416304

INSTRUMENTATION ENGINEERING DEPARTMENT

DEGREE PROGRAMME: A. Y. 2022 - 23

INDUSTRIAL TRAINING (B.Tech Instrumentation)

Sr. No.	PRN No.	Name of Student	Days	Industry
1	PRN:1962691466004	Pawar Pratik Prakash	35	Orbit Solution
2	PRN:1962691466007	Magar Harshad Manik	45	Shanti Engineer
3	PRN:1962691466015	Nalawade Ajinkya Dattatray	15	Ganlaxmi Ind
4	PRN:1962691466016	Mohite Nikita Pradip	15	Ganlaxmi Ind
5	PRN:1962691466032	Patil Shubham Jaysing	35	Orbit Solution
6	PRN:1962691466033	Mali Vishal Sanjay	35	Orbit Solution
7	PRN:1962691466034	Shekh Mahanmadijaj Mahanmadrafiq	15	IND-IoT
8	PRN:1962691466036	Nandiwale Vishal Kakaso	16	IOSCAPE
9	PRN:1962691466042	Kulkarni Parag Harshal	42	J Mechatronics
10	PRN:1962691466054	Patil Raturaj Sadashiv	-	-
11	PRN:1962691466062	Nandre Pratik Adinath	35	Orbit Solution
12	PRN:2062691466001	Rushikesh Dipak Koparde	15	IND-IoT
13	PRN:2062691466002	Patil Sudarshan Shahaji	-	-
14	PRN:2062691466003	Bhosale Ninad Ramdas	15	Ganlaxmi Ind
15	PRN:2062691466004	Mahanur Asawari Sambhaji	16	Pragati Ind
16	PRN:2062691466005	Pawar Vaishnavi Sanjay	16	Pragati Ind
17	PRN:2062691466006	Dalavi Sanket Dilip	15	Ganlaxmi Ind
18	PRN:2062691466007	Hulle Sourabh Shital	28	Hem
19	PRN:2062691466008	Jayappa Suraj Rajaram	28	Hem
20	PRN:2062691466009	Kupwade Mayuri Ravindra	15	Ganlaxmi Ind
21	PRN:2062691466010	Patil Nikita Anil	15	Ganlaxmi Ind
22	PRN:2062691466011	Patil Aboli Prakash	15	Ganlaxmi Ind



Dr. Vasantodada Patil Shetkari Shikshan Mandal

PADMABHOOSHAN VASANTODADA PATIL INSTITUTE OF
TECHNOLOGY, BUDHGAON- 416304

INSTRUMENTATION ENGINEERING DEPARTMENT

DEGREE PROGRAMME: A. Y. 2022 - 23

INDUSTRIAL TRAINING (BE Instrumentation)

Sr. No.	PRN No.	Name of Student	Days	Industry
23	PRN:2062691466012	Patil Aviraj Sambhaji	28	Hem
24	PRN:2062691466013	Wakshe Ganesh Mohan	-	-
25	PRN:2062691466014	Suryawanshi Varad Sunil	28	DSD Security
26	PRN:2062691466015	Yelavikar Pavan Janardan	15	Ganlaxmi Ind
27	PRN:2062691466016	Dasharath M. Dhere	15	Vapco
28	PRN:2062691466017	Pawaskar Vallari S.	28	Hem
29	PRN:2062691466018	Desai Prafulla P.	15	Ganlaxmi Ind
30	PRN:2062691466019	Rajopadhye Shubham Vasudev	35	Orbit Solution
31	PRN:2062691466020	Kothawale Aashpak Iqbal	-	-
32	PRN:2062691466021	Patil Swapnil Tukaram	-	-
33	PRN:2062691466023	Mane Vidnyan Prakash	-	-
34	PRN:2062691466022	Patil Prathmesh	-	-

[Signature]

Industrial Training
Coordinator

[Signature]

HOD
Instru. Engg.

ORBIT SOLUTIONS

Address: Matoshri Complex, Shop no 3&4, 100 ft road, Trimurti Chowk, Sangli. 416416

Contact: 0966517711, 09908879652, web: www.orbit-solutions.in Email: orbitolution4u@gmail.com

Ref. C20/21/2023

Date: 16/2/2023

To whomsoever it may concern

This is to certify that **Mr. Pratik Prakash Pawar** of Instrumentation department from Padmabhushan Vasantdada Patil Institute of Technology, Budhagaon has undergone training on Industrial products of our company. His training tenure was from 10th January to 15th February 2023.

During this period we have found his good technical ability and team efforts. He has good work ethics to improve his knowledge & technical skills. We appreciate his work initiative & commitment towards company. We wish him bright & successful future.

ORBIT
SOLUTIONS

Yours faithfully,

FOR ORBIT SOLUTION

SHANTI ENGINEERS

R.S. No.562/1 near Itayat Roadlines M.I.D.C.Shiroli, Kolhapur

TO WHOM IT IS CONCEREN

This is to certify that Mr.Harshad Manik Magar is working in our organization as a Trainee Engineers. The details of his experience are as mentioned below. He is honest & sincere in his duties.

- 1) Name :- Harshad Manik Magar
- 2) Qualification :- DME (Appear)
- 3) Date of Joining :- 10/07/2022
- 4) Details of Experience :- Trainee Engineers
- 5) Date of Leaving :-25/08/2022
- 6) Overall Performance :- Good

From, SHANTI ENGINEERS



CERTIFICATE

This certificate is presented to

Nalawade Ajiakya Dattatray

Has successfully completed " Industrial Automation " short term training of 15 days from 15/02/2023 to 03/03/2023

Organised by Ganalaxmi Industries which covers

- PLC - ALLEN BRADLEY, SIEMENS
- HMI - DELTA, ABB

Ganalaxmi Industries

Email-ganalaxmiindustries@gmail.com
Visit us- www.ganalaxmiindustries.com
Contact No. 9284566266



Authorized Sign

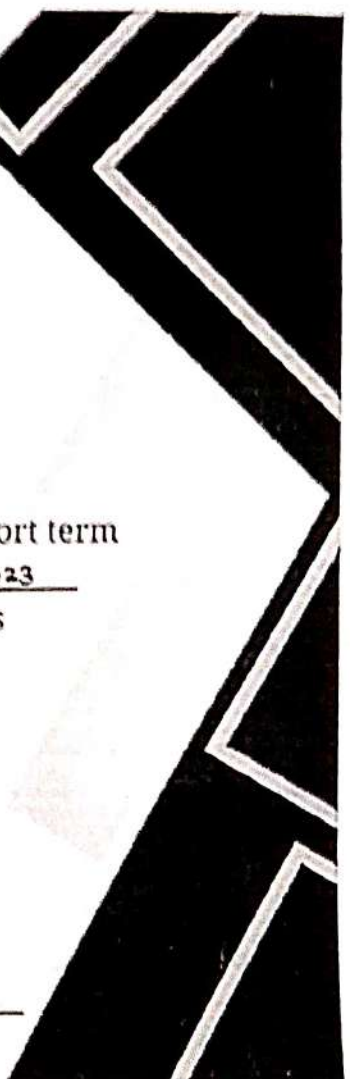

Certificate of Completion

This Certificate is presented to

Ajinkya Dattatray Nalawade

For Successful completion of the

C & C++ Course in Jan 2023



Artisan Technologies
Training Department

Serial No:

SN/6 2023 245

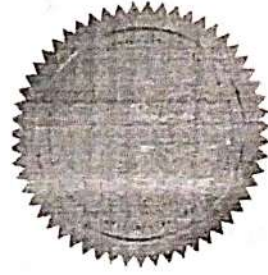



CERTIFICATE

This certificate is presented to

Mohite Nikita Pradip

Has successfully completed " Industrial Automation " short term
 training of 15 days from 15/02/2023 to 03/03/2023
 Organised by Ganalaxmi Industries which covers

- PLC - ALLEN BRADLEY, SIEMENS
- HMI - DELTA, ABB

Ganalaxmi Industries

Email-ganalaxmiindustries@gmail.com
 Visit us- www.ganalaxmiindustries.com
 Contact No.9284566266



Authorized Sign

ORBIT SOLUTIONS

Address: Matoshri Complex, Shop no J&J, 100 ft road, Trimurti Chowk, Sangli, 416416
Contact: 09665177711, 09960079682, web: www.orbit-solutions.in Email: orbitolution4u@gmail.com

Ref: OS/31/23-1

Date: 16/02/2023

To whomsoever it may concern

This is to certify that **Mr. Shubham Jaysing Patil** of Instrumentation department from Padmabhushan Vasantdada Patil Institute of Technology, Budhagaon has undergone training on Industrial products of our company. His training tenure was from 10th January to 15th February 2023.

During this period we have found his good technical ability and team efforts. He has good work ethics to improve his knowledge & technical skills. We appreciate his work initiative & commitment towards company. We wish him bright & successful future.

**ORBIT
SOLUTIONS**

Yours faithfully,

FOR ORBIT SOLUTION

ORBIT SOLUTIONS

Address: Matoshri Complex, Shop no 3&4, 100 ft road, Trimurti Chowk, Sangli. 416416

Contact: 09665177711, 09960079652, web: www.orbit-solutions.in Email: orbitsolution4u@gmail.com

Ref: OS/IT/23-06

Date: 16/03/2023 .

To whomsoever it may concern

This is to certify that **Mr. Vishal Sanjay Mali** of Instrumentation department from Padmabhushan Vasantdada Patil Institute of Technology, Budhagaon has undergone training on Industrial products of our company. His training tenure was from 10nd January to 15th February 2023.

During this period we have found his good technical ability and team efforts. He has good work ethics to improve his knowledge & technical skills. We appreciate his work initiative & commitment towards company. We wish him bright & successful future.

**ORBIT
SOLUTIONS**

Yours faithfully,

FOR ORBIT SOLUTION

IND-IoT Automation LLP

IoT • Industrial IoT • Automation • IoT Product Development

Ref: Training/2223/12

Date: 16/03/2023

To whomsoever, it may concern,

This is to certify that **Mr. Mahanmadijaj Shekh** from PVPIT, Budhgaoan (B.Tech Instru.) has successfully completed 15 days (01/03/2023 to 15/03/2023) of **Technical Training** in our company.

During the training program, he was **punctual, hardworking, and inquisitive**. We wish him success in his future endeavors.

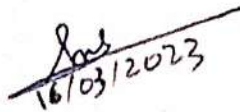
16/03/2023

Mr. Rutvik Milind Sidhaye
Director - Designated Partner
IND-IoT Automation LLP

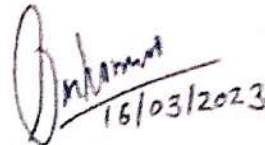

16/03/2023

Mr. Vinay M. Honrao
Director - Designated Partner
IND-IoT Automation LLP

To validate this certificate, call on +919529343490

Office Address:
B-1, Samarth Icon, Opp SBI
Vishrambag, Sangli -416415

Reg. Address:
H. No.154, Subhashnagar,
Miraj-416410

+919762463995 / +918600786380
indiot.automation@gmail.com



IOSCAPE

Edge Sensing & Cloud Control



ioscape Intelitech Private Limited
Dhavalgiri, Plot No 23B, Sr No 3616,
Lakshminagar, Kupwad Road,
Sangli Maharashtra India 416416



+91-233-3553237



support@ioscape.io
<https://ioscape.io>

Date: 10th March 2023

TO WHOMSOEVER IT MAY CONCERN

This is to certify that Mr. Vishal Kakaso Nandiwale, B.TECH. INSTRU student of P.V.P. INSTITUTE OF TECHNOLOGY, BUDHGAON has successfully completed training in our organization from 20th Feb 2023 to 9th March 2023. The training consisted of the basics of electronics, building circuits, and simulation of circuits.

We wish Vishal all the best in his future Endeavours.

Padmaraj Jain

Padmaraj Jain
Co-Founder and Director,
ioscape Intelitech Private Limited

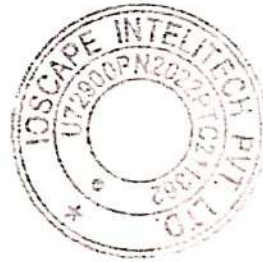

ORBIT SOLUTIONS

Address: Mazodhari Complex, Shop no 3&4, 100 ft road, Trimurti Chowk, Sangli. 416416

Contact: 9944517711, 9944479052, web: www.orbit-solutions.in Email: orbitolution4u@gmail.com

Ref: 05/27/23-04

Date: 16/03/2023.

To whomsoever it may concern

This is to certify that Mr. Pratik Adinath Nandre of Instrumentation department from Padmabhushan Vasantdada Patil Institute of Technology, Budhagaon has undergone training on Industrial products of our company. His training tenure was from 10th January to 15th February 2023.

During this period we have found his good technical ability and team efforts. He has good work ethics to improve his knowledge & technical skills. We appreciate his work initiative & commitment towards company. We wish him bright & successful future.

**ORBIT
SOLUTIONS**



Yours faithfully,

FOR ORBIT SOLUTION

IND-IoT Automation LLP

IoT = Industrial IoT = Automation = IoT Product Development

Ref: Training/2223/11

Date:16/03/2023

To whomsoever, it may concern,

This is to certify that **Mr. Rushikesh Dipak Koparde** from PVPIT, Budhgaon (B.Tech Instru.) has successfully completed 15 days (01/03/2023 to 15/03/2023) of **Technical Training** in our company.

During the training program, he was **punctual, hardworking, and inquisitive.** We wish him success in his future endeavors.

[Signature]
16/03/2023

Mr. Rutvik Milind Sidhaye
Director - Designated Partner
IND-IoT Automation LLP



[Signature]
16/03/2023

Mr. Vinay M. Honrao
Director - Designated Partner
IND-IoT Automation LLP

To validate this certificate, call on +919525343490

Office Address:
B-1, Samarth Icon, Opp SBI
Wastrambag, Sangli -415415

Reg. Address:
H. No 154, Subhashnagar,
Miraj-415410

+919762463995 / +918600786380
indiot.automation@gmail.com



**GANALAXMI
INDUSTRIES**

CERTIFICATE

This certificate is presented to

Bhosale Ninad Ramdas.

Has successfully completed “ Industrial Automation ” short term training of 15 days from 15/02/2023 to 03/03/2023
Organised by **Ganalaxmi Industries** which covers

- PLC – ALLEN BRADLEY,SIEMENS
- HMI –DELTA,ABB

Ganalaxmi Industries
Email-ganalaxmiindustries@gmail.com
Visit us- www.ganalaxmiindustries.com
Contact No.9284566266



Authorized Sign

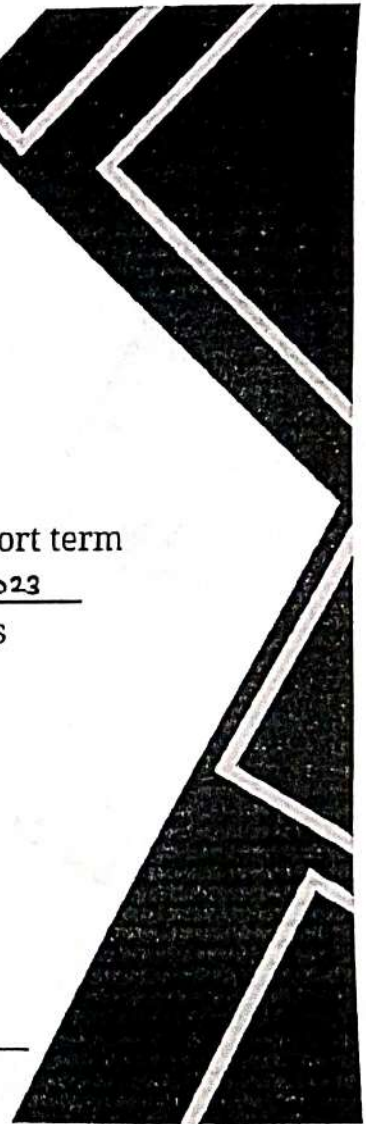



AN IOS 9001:2008 CERTIFIED COMPANY

INDUSTRIES

Plot No.134, Industrial Estate, Sangli - 416 416. (Mah.) India
Phone - (0233) 2310942 / 43 Fax : 2310941, 9423868898 / 99
Web : <http://www.centrifugalpumpindia.in>
Email : pragatisangli@gmail.com info@centrifugalpumpindia.in

Manufacturers & Suppliers of : Pumps & Spares, Mill Spares, V. T. Pump Spares, Ferrous & Non Ferrous Castings.

Sub : Training Certificate
To Whomsoever it may concern.

This is to be certified that Miss. Asawari Sambhaji Mahanur was working with our company from 11-JANUARY-2023 TO 27-JANUARY-2023 she successfully completed her industrial training at PRAGATI INDUSTRIES MFG of Pump & Pumps spares.

Her responsibilities included working on lathe machine. we are information to her all over manufactured pump spares parts .

During this training period we found her a sincere honest dedicated trainee with a professional attitude and good job knowledge we found her work Satisfactory because of her Sincerity dedication and hard work.

We wish her all the best and success in his future career end over's.

For Pragati Industries

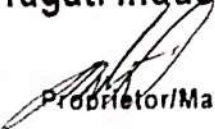
Proprietor/Manager





AN ISO 9001:2008 CERTIFIED COMPANY

INDUSTRIES

Plot No. 134, Industrial Estate, Sangli - 416 416. (Mah.) India
Phone - (0233) 2310942 / 43 Fax : 2310941, 9423868898 / 99
Web : <http://www.centrifugapumpindia.in>
Email : pragatisangli@gmail.com info@centrifugapumpindia.in

Manufacturers & Suppliers of Pumps & Spares, Mill Spares, V. T. Pump Spares, Ferrous & Non Ferrous Castings.

Sub : Training Certificate
To Whomsoever it may concern.

It is to be certified that Miss. Vaishnavi Sanjay Pawar was working with our company from 11-
JANUARY-2023 TO 27-JANUARY-2023 she successfully completed her industrial training at PRAGATI
INDUSTRIES MFG of Pump & Pumps spares.

Her responsibilities included working on lathe machine. we are information to her all over
manufactured pump spares parts

During this training period we found her a sincere honest dedicated trainee with a professional attitude
and good job knowledge we found her work Satisfactory because of her Sincerity dedication and hard
work.

We wish her all the best and success in his future career and over's.

For Pragati Industries

Proprietor/Manager





CERTIFICATE

This certificate is presented to

Dalavi Sanket Dilip.

Has successfully completed " Industrial Automation " short term training of 15 days from 15/02/2023 to 03/03/2023
Organised by **Ganalaxmi Industries** which covers

- PLC - ALLEN BRADLEY, SIEMENS
- HMI - DELTA, ABB

Ganalaxmi Industries

Email- ganalaxmiindustries@gmail.com
Visit us- www.ganalaxmiindustries.com
Contact No. 9224566266



Authorized Sign



HEM ELECTRONIQUES

C-46, M.I.D.C. Industrial Area, MIRAJ-416410(MAHARASHTRA)
PH:-+91-233-2644324,2645201(telefax)
Email:- san_hem@bsnl.com, hem_contact@yahoo.co.in

Designers and Manufacturers of Educational Electronic Equipments

DT:-15/12/2022

SUB :-IN HOUSE PLC TRAINING CERTIFICATE

To Whom It May Concern,

This is to certify that ,

Mr. SOURABH SHITAL HULLE FROM PVPIT BUDHGAON

has under gone

IN HOUSE 4 WEEKS TRAINING PROGRAM ON

PLC(Programmable Logic Controllers) and Industrial automation in our organization

He has under gone training in Programming and Testing of ,

- a)Allen Bradley ,Micrologix1100
- b)Crouzet PLC
- d)Introduction to SCADA Concept.
- e)Introduction to AC/DC drives, instrumentation, control technology.
- g)Hardware interfacing to real time system
- i)HUMAN MACHINE INTERFACE (HMI) .

He is hardworking and bears a good moral character. We wish him all the best for his future career.

With Best Regards
Ashwin Gadgil
For Hem Electroniques Miraj



(*CERTIFICATE CAN NOT BE USED AS PROOF OF ATTENDANCE ON ANY PARTICULAR DATE)

Visit us at www.hemelectroniques.com



HEM ELECTRONICS

U-49, A11111 Industrial Area, Mira-Estate(MIRABASITRA)

Pin: 401 233-2011371,20120111371

Email: www.hem@hem.com, tech_contact@yatraa.co.in

Designer and Manufacturer of Educational Electronic Equipment

DT:15/12/2022

SUB :-IN HOUSE PLC TRAINING CERTIFICATE

To Whom It May Concern,

This is to certify that ,

Mr. SURAJ RAJARAM JAYAPPA FROM PVPIT BUDHGAON

has under gone

IN HOUSE 4 WEEKS TRAINING PROGRAM ON

PLC(Programmable Logic Controllers) and Industrial automation in our organization

He has under gone training in Programming and Testing of ,

a)Allen Bradley ,Micrologix1100

b)Crouzet PLC

d)Introduction to SCADA Concept,

e)Introduction to AC/DC drives, Instrumentation, control technology,

g)Hardware Interfacing to real time system

l)HUMAN MACHINE INTERFACE (HMI)

He is hardworking and bears a good moral character. We wish him all the best for his future career.

With Best Regards

Ashwin Gadgil

For Hem Electroniques MiraJ



(*CERTIFICATE CAN NOT BE USED AS PROOF OF ATTENDANCE ON ANY PARTICULAR DATE)

Visit us at www.hemelectronicques.com



**GANALAXMI
INDUSTRIES**

CERTIFICATE

This certificate is presented to

Kupwade Mayuri Ravindra

Has successfully completed " Industrial Automation " short term
training of 15 days from 15/02/2023 to 03/03/2023
Organised by Ganalaxmi Industries which covers

- PLC - ALLEN BRADLEY, SIEMENS
- HMI - DELTA, ABB

Ganalaxmi Industries

Email- ganalaxmiindustries@gmail.com
Visit us- www.ganalaxmiindustries.com
Contact No. 9284566266

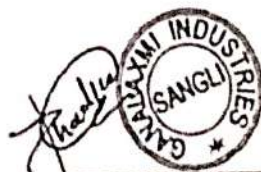

Authorized Sign



**GANALAXMI
INDUSTRIES**

CERTIFICATE

This certificate is presented to

Patil Nikita Anil

Has successfully completed " Industrial Automation " short term training of 15 days from 15/02/2023 to 03/03/2023

Organised by Ganalaxmi Industries which covers

- PLC - ALLEN BRADLEY, SIEMENS
- HMI - DELTA, ABB

Ganalaxmi Industries

Email-ganalaxmiindustries@gmail.com
Visit us- www.ganalaxmiindustries.com
Contact No. 9284566200



Authorized Sign



**GANALAXMI
INDUSTRIES**

CERTIFICATE

This certificate is presented to

Patil Abeli Prakash

Has successfully completed " Industrial Automation " short term
training of 15 days from 15/03/2023 to 03/03/2023

Organised by Ganalaxmi Industries which covers

- PLC - ALLEN BRADLEY, SIEMENS
- HMI - DELTA, ABB

Ganalaxmi Industries

Email- ganalaxmiindustries@gmail.com
Visit us- www.ganalaxmiindustries.com
Contact No. 9284566266



Authorized Sign



HEM ELECTRONIQUES

C-43, MIDC Industrial Area, MIRAJ-410410(MAHARASHTRA)
PH: (91)-233-2611321, 2613201 (telefax)
Email: hem_electronics@hem_electronics.com

Designers and Manufacturers of Educational Electronic Equipments

DT:-15/12/2022

SUB :-IN HOUSE PLC TRAINING CERTIFICATE

To Whom It May Concern,

This is to certify that ,

Mr. AVIRAJ SAMBHAJI PATIL FROM PVPIT BUDHGAON

has under gone

IN HOUSE 4 WEEKS TRAINING PROGRAM ON

PLC(Programmable Logic Controllers) and Industrial automation in our organization

He has under gone training in Programing and Testing of ,

- a) Allen Bradley ,Micrologix1100
- b)Crouzet PLC
- d)Introduction to SCADA Concept,
- e)Introduction to AC/DC drives, Instrumentation, control technology,
- g)Hardware interfacing to real time system
- l)HUMAN MACHINE INTERFACE (HMI)

He is hardworking and bears a good moral character. We wish him all the best for his future career.

With Best Regards
Ashwin Gadgil
For Hem Electronics Miraj



(*CERTIFICATE CAN NOT BE USED AS PROOF OF ATTENDANCE ON ANY PARTICULAR DATE)

Visit us at www.hemelectronics.com

DSD

Reg. No.: II/15720/15 DT.1/1/2015

SECURITY SERVICES

9665510514
dsd9665@gmail.com

SHOP NO. 01, SHREE COMPLEX, S. T. COLONY, VISHRAMBAG, SANGLI.

Ref. No.:

Date: 1/03/2023

TRAINING CERTIFICATE

This is to certify that **MR. Varad S. Suryawanshi** B.TECH student degree program of PVPIT, Sangli. Has completed Industrial training at our organization from **1st FEB 2023 to 28th FEB 2023** during this training we found him sincere and hardworking.

We wish him best luck in his future ventures.

Date- 1st March 2023

Place-

Yours faithfully

DSD SECURITY SERVICES





**GANALAXMI
INDUSTRIES**

CERTIFICATE

This certificate is presented to

Yelaviker Pavan Tanardhan

Has successfully completed " Industrial Automation " short term
training of 15 days from 15/02/2023 to 03/03/2023
Organised by **Ganalaxmi Industries** which covers

- PLC - ALLEN BRADLEY,SIEMENS
- HMI -DELTA,ABB

Ganalaxmi Industries

Email-ganalaxmiindustries@gmail.com
Visit us- www.ganalaxmiindustries.com
Contact No.9284566266



Authorized Sign



HEM ELECTRONIQUES

Unit, Miraj Industrial Area, MIRAJ-DHOLE(MHARASHTRA)
Pin-411011-211-211,2112011211211
Email: hem_contact@yahoo.co.in

DESIGNER and MANUFACTURERS of Educational Electronic Equipments

DT:18/12/2022

SUB :-IN HOUSE PLC TRAINING CERTIFICATE

To Whom It May Concern,

This is to certify that ,

Mr. VALLARI SUSHIL PAWASKAR FROM PVPIT DUDHGAON

has under gone

IN HOUSE 4 WEEKS TRAINING PROGRAM ON

PLC(Programmable Logic Controllers) and Industrial automation in our organization

He has under gone training in Programming and Testing of ,

a)Allen Bradley ,Micrologix1100

b)Crouzet PLC

d)Introduction to SCADA Concept,

e)Introduction to AC/DC drives, Instrumentation, control technology,

g)Hardware interfacing to real time system

i)HUMAN MACHINE INTERFACE (HMI)

He is hardworking and bears a good moral character. We wish him all the best for his future career.

With Best Regards
Ashwin Gadgil
For Hem Electroniques Miraj



(*CERTIFICATE CAN NOT BE USED AS PROOF OF ATTENDANCE ON ANY PARTICULAR DATE)

Visit us at www.hemelectroniques.com



**GANALAXMI
INDUSTRIES**

CERTIFICATE

This certificate is presented to

Desai Prafulla Prakash

Has successfully completed " Industrial Automation " short term
training of 15 days from 15/02/2023 to 03/03/2023
Organised by **Ganalaxmi Industries** which covers

- PLC - ALLEN BRADLEY, SIEMENS
- HMI - DELTA, ABB

Ganalaxmi Industries
Email- ganalaxmiindustries@gmail.com
Visit us- www.ganalaxmiindustries.com
Contact No. 9284566266



Authorized Sign

ORBIT SOLUTIONS

Address: Manohar Complex, Shop no 3&4, 100-ft road, Trimburch (Bunk), Sangli, 436416
Contact: 09665177711, 099660179652, web: www.orbit-solutions.in Email: orbit@orbit-solutions.in

Ref: OS/17/982

Date: 15/02/2023

To whomsoever it may concern

This is to certify that Mr. Ashpak Iqbal Kothawale of Instrumentation department from Padmabhushan Vasantdada Patil Institute of Technology, Budhaganan has undergone training on Industrial products of our company. His training tenure was from 10th January to 15th February 2023.

During this period we have found his good technical ability and team efforts. He has good work ethics to improve his knowledge & technical skills. We appreciate his work initiative & commitment towards company. We wish him bright & successful future.

ORBIT
SOLUTIONS

Yours faithfully,

FOR ORBIT SOLUTION

Department
Academic Year
Class

Instrumentation & Control Engineering
2022-23
SY Btech

Industrial Training Data SY INSTRUMENTATION & CONTROL 2022-2023

Sr.No	Name Of the Student	From Date	Date To	Company Name
1	SHEKHAR SHIVAJI PATIL			
2	IRSHAD JAMIR PATHAN	01.02.2023	15.02.2023	Electro India Sangli
3	TEJAS KISHOR GORE	06.02.2023	18.02.2023	Patil Dairy Bhilwadi
4	GANESH ARJUN CHOUGULE	06.02.2023	22.02.2023	World Of Automation Pune
5	RUSHIKESH GAJANAN SHINDE	01.02.2023	15.02.2023	Electro India Sangli
6	AMAR SUBHASH PATIL			
7	VAIBHAV SATISH LAD	07.02.2023	21.02.2023	Electro India Sangli
8	ASHITOSH MAHESH SHETTY	07.02.2023	21.02.2023	Electro India Sangli
9	PRASAD SHARAD PATWARDHAN			
10	AISHWARYA VIDHYANAND DIXIT	01.02.2023	15.02.2023	Electro India Sangli
11	PRAJYOT PANDITRAO PATIL	01.02.2023	15.02.2023	Electro India Sangli
12	PRANJALI PANDURANG PATIL	01.02.2023	15.02.2023	Electro India Sangli
13	SANDIP SAMBHAJI SUTAR	06.02.2023	22.02.2023	World Of Automation Pune
14	DHANRAJ ANANDRAO YEWALE	27.06.2023	11.07.2023	Electro India Sangli
15	ADITYA DHANANJAY KARANDE	07.02.2023	21.02.2023	Electro India Sangli
16	JUBER DILAWAR NAVALAGI			
17	SHUBHAM SUNIL MAHINDRAKAR	27.06.2023	11.07.2023	Electro India Sangli
18	VISHWAJEET SANJAY HARUGADE	27.06.2023	11.07.2023	Electro India Sangli
19	ANAND MUTTAPPA MALI	27.06.2023	11.07.2023	Electro India Sangli
20	SUHEL GABBAR GOLANDAJ	07.02.2023	21.02.2023	Electro India Sangli
21	JYOTI MAHADEV PATIL	27.06.2023	11.07.2023	Electro India Sangli
22	RAMCHANDRA SHIVAJI GAWADE			
23	SANIKA PRASHANT MAGDUM	27.06.2023	11.07.2023	Electro India Sangli
24	AISHWARYA SURESH RANDIVE	27.06.2023	11.07.2023	Electro India Sangli
25	POONAM ANIL MAGDUM	27.06.2023	11.07.2023	Electro India Sangli
26	SAKSHAM SUNIL DHERE	27.06.2023	11.07.2023	Electro India Sangli
27	RAMJAN NABI SHAIKH			
28	SHRADDHA VIJAY LAVTE	NA	NA	NA
29	FAYEEZ ZAKIR PEERZADE			
30	CHETAN VASANT PATIL			
31	PRAMOD DATTATRAY PATIL	10.02.2023	26.02.2023	Shree Dudhganga Vedganga Sugar Factory Bidri

Summary		
Sr.No	Company Name	Number Of Students
1	Electro India Sangli	18
2	Patil Dairy Bhilawadi	1
3	World of Automation	2
4	Shree Dudhganga Vedganga Sugar Factory Bidri	1
5	Remaining	8
	Total	30



M. H. Grade

HOD



MANUFACTURER, SALES & SERVICES OF
ELECTRONIC WEIGHING MACHINE
An ISO 9001:2008 Certified Company

LG ELECTRO INDUSTRIES

- CORPORATE OFFICE**
PLOT NO. 20, GHANSHYAM NAGAR, MADHAVNAGAR ROAD,
SANGLI - 416 416. (MAHARASHTRA) PH : 0233-2314242
- Email : electroindia14@gmail.com || electroindiaindustries@gmail.com
- Mobile : 9422506828, 9422409458 || www.electro-india.in

Date – 16 /2 /23

TRAINING CERTIFICATE

This is to certify that, **Mr. Irshad Jamir Pathan . Of Degree 2nd yr Instrumentation & Control from the College PVPIT Budhgaon** has completed Industrial Training in **Electro India Sangli** in the Period of **1 Feb.2023 to 15 Feb.2023**.According to this he completed **15 Days** training.

In the training period we found him a sincere, honest, hardworking, dedicated trainee with a professional attitude and very good job knowledge. In this duration we gave him training of all types of weighing machines in two sections namely hardware section and software section . We found him work satisfactory because of his sincerity, dedication and hard work.

We have found him to be a self starter who is new invention view. We wish him all the best and success in future career.

For Electro-India



(Authorized Signatory)



आपला प्रत्येक ग्रॅम हक्काचा....इलेक्ट्रो इंडिया...!

PATIL DAIRY PRODUCTS

- A/p. Malwadi (Bhilawadi). Tal. Palus, Dist. Sangli
□ Mob.: 96 89 88 38 02 □ Web : www.patildairy.com
□ E-mail : patildairy007@gmail.com



पा./डे./प्रॉ./जा.क्र. 70-2022-23

दिनांक 21/02/2023

Certificate

This is to certify that **Mr. Tejas Kishor Gore**, B.Tech II Student from Department of Instrumentation and Control, P.V.P.I.T Budhgaon have successful completed his project on "**Industrial Training**" in our Organization from 06.02.2023 to 18.02.2023.

During the project work he has shown keen interest and found to be sincere and hard working.

We wish his every success in his future endeavors. This certificate is issued on his request.

PATIL DAIRY PRODUCTS,

Proprietor

-  **CORPORATE OFFICE**
PLOT NO. 20, GHANSHYAM NAGAR, MADHAVNAGAR ROAD,
SANGLI - 416 416. (MAHARASHTRA) PH : 0233-2314242
-  Email : electroindia14@gmail.com || electroindiaindustries@gmail.com
-  Mobile : 9422506828, 9422409458 || www.electro-india.in

Date – 16 /2 /23

TRAINING CERTIFICATE

This is to certify that, **Mr. Rushikesh Gajanan Shinde** . Of Degree 2nd yr Instrumentation & Control from the College PVPIT Budhgaon has completed Industrial Training in **Electro India Sangli** in the Period of 1 Feb.2023 to 15 Feb.2023. According to this he completed 15 Days training.

In the training period we found him a sincere, honest, hardworking, dedicated trainee with a professional attitude and very good job.knowledge. In this duration we gave him training of all types of weighing machines in two sections namely hardware section and software section . We found him work satisfactory because of his sincerity, dedication and hard work.

We have found him to be a self starter who is new invention view. We wish him all the best and success in future career.

For Electro-India



(Authorized Signatory)



आपला प्रत्येक ग्रॅम हक्काचा....इलेक्ट्रो इंडिया...!



ELECTRO - INDIA

Best Way to Weigh

MANUFACTURER, SALES & SERVICES OF
ELECTRONIC WEIGHING MACHINE
An ISO 9001:2008 Certified Company

LG ELECTRO INDUSTRIES



CORPORATE OFFICE

PLOT NO. 20, GHANSHYAM NAGAR, MADHAVNAGAR ROAD,
SANGLI - 416 416. (MAHARASHTRA) PH : 0233-2314242



Email : electroindia14@gmail.com ■ electroindiaindustries@gmail.com



Mobile : 9422506828, 9422409458 ■ www.electro-india.in

Date – 23/2 /23

TRAINING CERTIFICATE

This is to certify that, **Mr. Vaibhav Satish Lad. Of Degree 2nd yr Instrumentation & Control Eng. from the College PVPIT Budhgaon** has completed Industrial Training in **Electro India Sangli** in the Period of **7 Feb.2023 to 21 Feb.2023**.According to this he completed **15 Days** training.

In the training period we found him a sincere, honest, hardworking, dedicated trainee with a professional attitude and very good job knowledge. In this duration we gave him training of all types of weighing machines in two sections namely hardware section and software section . We found him work satisfactory because of his sincerity, dedication and hard work.

We have found him to be a self starter who is new invention view. We wish him all the best and success in future career.

For Electro-India

(Authorized Signatory)



आपला प्रत्येक ग्रॅम हक्काचा....इलेक्ट्रो इंडिया...!





ELECTRO - INDIA

Best Way to Weigh

MANUFACTURER, SALES & SERVICES OF
ELECTRONIC WEIGHING MACHINE
An ISO 9001:2008 Certified Company

LG ELECTRO INDUSTRIES

- 📍 **CORPORATE OFFICE**
PLOT NO. 20, GHANSHYAM NAGAR, MADHAVNAGAR ROAD,
SANGLI - 416 416. (MAHARASHTRA) PH : 0233-2314242
- ✉ **Email :** electroindia14@gmail.com || electroindiaindustries@gmail.com
- 📞 **Mobile :** 9422506828, 9422409458 || www.electro-india.in

Date – 23/2 /23

TRAINING CERTIFICATE

This is to certify that, **Mr. Ashitosh Mahesh Shetty**. Of Degree 2nd yr Instrumentation & Control Eng. from the College PVPIT Budhgaon has completed Industrial Training in **Electro India Sangli** in the Period of **7 Feb.2023 to 21 Feb.2023**. According to this he completed **15 Days** training.

In the training period we found him a sincere, honest, hardworking, dedicated trainee with a professional attitude and very good job knowledge. In this duration we gave him training of all types of weighing machines in two sections namely hardware section and software section . We found him work satisfactory because of his sincerity, dedication and hard work.

We have found him to be a self starter who is new invention view. We wish him all the best and success in future career.

For Electro-India

(Authorized Signatory)



आपला प्रत्येक ग्रॅम हक्काचा....इलेक्ट्रो इंडिया...!





MANUFACTURER, SALES & SERVICES OF
ELECTRONIC WEIGHING MACHINE
An ISO 9001:2008 Certified Company

10

LG ELECTRO INDUSTRIES

- CORPORATE OFFICE
PLOT NO. 20, GHANSHYAM NAGAR, MADHAVNAGAR ROAD,
SANGLI - 416 416. (MAHARASHTRA) PH : 0233-2314242
- Email : electroindia14@gmail.com ■ electroindiaindustries@gmail.com
- Mobile : 9422506828, 9422409458 ■ www.electro-india.in

Date – 16/2/23

TRAINING CERTIFICATE

This is to certify that, **Miss. Aishwarya Vidhyanand Dixit.** of Degree 2nd yr Instrumentation & Control from the College PVPIT Budhgaon has completed Industrial Training in **Electro India Sangli** in the Period of 1 Feb. 2023 to 15 Feb. 2023. According to this she completed 15 Days training.

In the training period we found her a sincere, honest, hardworking, dedicated trainee with a professional attitude and very good job knowledge. In this duration we gave her training of all types of weighing machines in two sections namely hardware section and software section . We found her work satisfactory because of her sincerity, dedication and hard work.

We have found her to be a self starter who is new invention view. We wish her all the best and success in future career.

For Electro-India

(Authorized Signatory)



आपला प्रत्येक ग्रॅम हक्काचा....इलेक्ट्रो इंडिया...!

MANUFACTURER, SALES & SERVICES OF
ELECTRONIC WEIGHING MACHINE
An ISO 9001:2008 Certified Company

11



ELECTRO - INDIA

Best Way to Weigh

LG ELECTRO INDUSTRIES

- CORPORATE OFFICE**
PLOT NO. 20, GHANSHYAM NAGAR, MADHAVNAGAR ROAD,
SANGLI - 416 416. (MAHARASHTRA) PH : 0233-2314242
- Email : electroindia14@gmail.com || electroindiaindustries@gmail.com
- Mobile : 9422506828, 9422409458 || www.electro-india.in

Date – 16/2/23

TRAINING CERTIFICATE

This is to certify that, **Mr. Prajyot Panditrao Patil**. Of Degree **2nd yr Instrumentation & Control** from the College **PVPIT Budhgaon** has completed Industrial Training in **Electro India Sangli** in the Period of **1 Feb.2023 to 15 Feb.2023**. According to this he completed **15 Days** training.

In the training period we found him a sincere, honest, hardworking, dedicated trainee with a professional attitude and very good job knowledge. In this duration we gave him training of all types of weighing machines in two sections namely hardware section and software section . We found him work satisfactory because of his sincerity, dedication and hard work.

We have found him to be a self starter who is new invention view. We wish him all the best and success in future career.

For Electro-India

(Authorized Signatory)



आपला प्रत्येक ग्रॅम हक्काचा....इलेक्ट्रो इंडिया...!



MANUFACTURER, SALES & SERVICES OF
ELECTRONIC WEIGHING MACHINE
An ISO 9001:2008 Certified Company

12

LG ELECTRO INDUSTRIES

- CORPORATE OFFICE**
PLOT NO. 20, GHANSHYAM NAGAR, MADHAVNAGAR ROAD,
SANGLI - 416 416. (MAHARASHTRA) PH : 0233-2314242
Email : electroindia14@gmail.com || electroindiaindustries@gmail.com
Mobile : 9422506828, 9422409458 || www.electro-india.in

Date - 16/2/23

TRAINING CERTIFICATE

This is to certify that, **Miss. Pranjali Pandurang Patil** of Degree 2nd yr Instrumentation & Control from the College PVPIT Budhgaon has completed Industrial Training in Electro India Sangli in the Period of 1 Feb. 2023 to 15 Feb. 2023. According to this she completed 15 Days training.

In the training period we found her a sincere, honest, hardworking, dedicated trainee with a professional attitude and very good job knowledge. In this duration we gave her training of all types of weighing machines in two sections namely hardware section and software section. We found her work satisfactory because of her sincerity, dedication and hard work.

We have found her to be a self starter who is new invention view. We wish her all the best and success in future career.

For Electro-India

(Authorized Signatory)



आपला प्रत्येक ग्रॅम हक्काचा....इलेक्ट्रो इंडिया...!



Excellent Training Quality

THE WORLD OF AUTOMATION

23/P/34

13

Certificate of Completion

This is certify that *Sandip Sambhaji Sutar* has successfully completed
15 days *PLC Training* from 06 Feb 2023 to 22 Feb. 2023 covering.

AB PLC

Intouch SCADA

BRANCH : CHINCHWAD

Manik Raj Park, 2nd Floor, Office No.4,
Oppo.Elpro City Square Mall, PCMC Link Road,
Chinchwad, Pune-411033.

8530094777 / 8530084777 / 9075102234

BRANCH : CHHATRAPATI SHIVAJINAGAR

Office No.3, Riverview, Ekta Park Society, Beside Chhatrapati
Shivaji Nagar Bus Stand, Wakdewadi, Pune - 411005.

7276695435 / 9075102234



[f](#) theworldofautomation
[t](#) TheWorldOfAuto1
[You Tube](#) UCXARihllgQgngl-6YdGduig
info@theworldofautomation.com
www.theworldofautomation.com

**Authorised
Signatory**



ELECTRO - INDIA

Best Way to Weigh

MANUFACTURER, SALES & SERVICES OF
ELECTRONIC WEIGHING MACHINE
An ISO 9001:2008 Certified Company

15

LG ELECTRO INDUSTRIES



CORPORATE OFFICE

PLOT NO. 20, GHANSHYAM NAGAR, MADHAVNAGAR ROAD,
SANGLI - 416 416. (MAHARASHTRA) PH : 0233-2314242



Email : electroindia14@gmail.com || electroindiaindustries@gmail.com



Mobile : 9422506828, 9422409458 || www.electro-india.in

Date – 23/2 /23

TRAINING CERTIFICATE

This is to certify that, **Mr. Aditya Dhananjay Karande**. Of Degree 2nd yr Instrumentation & Control Eng. from the College PVPIT Budhgaon has completed Industrial Training in Electro India Sangli in the Period of 7 Feb.2023 to 21 Feb.2023. According to this he completed 15 Days training.

In the training period we found him a sincere, honest, hardworking, dedicated trainee with a professional attitude and very good job knowledge. In this duration we gave him training of all types of weighing machines in two sections namely hardware section and software section . We found him work satisfactory because of his sincerity, dedication and hard work.

We have found him to be a self starter who is new invention view. We wish him all the best and success in future career.

For Electro-India



(Authorized Signatory)



आपला प्रत्येक ग्रॅम हक्काचा....इलेक्ट्रो इंडिया...!



Scanned with OKEN Scanner



MANUFACTURER, SALES & SERVICES OF
ELECTRONIC WEIGHING MACHINE
An ISO 9001:2008 Certified Company

17

LG ELECTRO INDUSTRIES

- CORPORATE OFFICE**
PLOT NO. 20, GHANSHYAM NAGAR, MADHAVNAGAR ROAD,
SANGLI - 416 416. (MAHARASHTRA) PH : 0233-2314242
- Email : electroindia14@gmail.com || electroindiaindustries@gmail.com
- Mobile : 9422506828, 9422409458 || www.electro-india.in

Date - 24/07/23

TRAINING CERTIFICATE

This is to certify that, **Mr. Shubham Sunil Mahindkar.** Of Degree 2nd yr Instrumentation & Control Engg. from the College PVPIT Budhgaon has completed Industrial Training in Electro India Sangli in the Period of 27 June.2023 to 11 July.2023. According to this he completed 2 Weeks training.

In the training period we found him a sincere, honest, hardworking, dedicated trainee with a professional attitude and very good job knowledge. In this duration we gave him training of all types of weighing machines in two sections namely hardware section and software section . We found him work satisfactory because of his sincerity, dedication and hard work.

We have found him to be a self starter who is new invention view. We wish him all the best and success in future career.

For Electro-India

(Authorized Signatory)



आपला प्रत्येक ग्रॅम हक्काचा....इलेक्ट्रो इंडिया...!



ELECTRO - INDIA

Best Way to Weigh

**MANUFACTURER, SALES & SERVICES OF
ELECTRONIC WEIGHING MACHINE**
An ISO 9001:2008 Certified Company

LG ELECTRO INDUSTRIES

-  **CORPORATE OFFICE**
PLOT NO. 20, GHANSHYAM NAGAR, MADHAVNAGAR ROAD,
SANGLI - 416 416. (MAHARASHTRA) PH : 0233-2314242
-  Email : electroindia14@gmail.com | electroindiaindustries@gmail.com
-  Mobile : 9422506828, 9422409458 | www.electro-india.in

Date – 24/07 /23

TRAINING CERTIFICATE

This is to certify that, **Mr. Vishwajeet Sanjay Hargude . Of Degree 2nd yr Instrumentation & Control Engg. from the College PVPIT Budhgaon has completed Industrial Training in Electro India Sangli in the Period of 27 June.2023 to 11 July.2023. According to this he completed 2 Weeks training.**

In the training period we found him a sincere, honest, hardworking, dedicated trainee with a professional attitude and very good job knowledge. In this duration we gave him training of all types of weighing machines in two sections namely hardware section and software section . We found him work satisfactory because of his sincerity, dedication and hard work.

We have found him to be a self starter who is new invention view. We wish him all the best and success in future career.

For Electro-India



(Authorized Signatory)



आपला प्रत्येक ग्रॅम हक्काचा....इलेक्ट्रो इंडिया...!



ELECTRO - INDIA

Best Way to Weigh

MANUFACTURER, SALES & SERVICES OF
ELECTRONIC WEIGHING MACHINE
An ISO 9001:2008 Certified Company

19

LG ELECTRO INDUSTRIES



CORPORATE OFFICE

PLOT NO. 20, GHANSHYAM NAGAR, MADHAVNAGAR ROAD,
SANGLI - 416 416. (MAHARASHTRA) PH : 0233-2314242



Email : electroindia14@gmail.com || electroindiaindustries@gmail.com



Mobile : 9422506828, 9422409458 || www.electro-india.in

Date - 24/07/23

TRAINING CERTIFICATE

This is to certify that, **Mr. Anand Muttapa Mali**. Of Degree 2nd yr Instrumentation & Control Engg. from the College PVPIT Budhgaon has completed Industrial Training in Electro India Sangli in the Period of 27 June.2023 to 11 July.2023. According to this he completed 2 Weeks training.

In the training period we found him a sincere, honest, hardworking, dedicated trainee with a professional attitude and very good job knowledge. In this duration we gave him training of all types of weighing machines in two sections namely hardware section and software section . We found him work satisfactory because of his sincerity, dedication and hard work.

We have found him to be a self starter who is new invention view. We wish him all the best and success in future career.

For Electro-India

(Authorized Signatory)



आपला प्रत्येक ग्रॅम हक्काचा....इलेक्ट्रो इंडिया...!





ELECTRO - INDIA

Best Way to Weigh

MANUFACTURER, SALES & SERVICES OF
ELECTRONIC WEIGHING MACHINE
An ISO 9001:2008 Certified Company

20

LG ELECTRO INDUSTRIES

-  **CORPORATE OFFICE**
PLOT NO. 20, GHANSHYAM NAGAR, MADHAVNAGAR ROAD,
SANGLI - 416 416. (MAHARASHTRA) PH : 0233-2314242
-  Email : electroindia14@gmail.com || electroindiaindustries@gmail.com
-  Mobile : 9422506828, 9422409458 || www.electro-india.in

Date – 23/2 /23

TRAINING CERTIFICATE

This is to certify that, **Mr. Suhel Gabbar Golandaj.** Of Degree 2nd yr Instrumentation & Control Eng. from the College PVPIT Budhgaon has completed Industrial Training in Electro India Sangli in the Period of 7 Feb.2023 to 21 Feb.2023. According to this he completed 15 Days training.

In the training period we found him a sincere, honest, hardworking, dedicated trainee with a professional attitude and very good job knowledge. In this duration we gave him training of all types of weighing machines in two sections namely hardware section and software section . We found him work satisfactory because of his sincerity, dedication and hard work.

We have found him to be a self starter who is new invention view. We wish him all the best and success in future career.

For Electro-India



(Authorized Signatory)



आपला प्रत्येक ग्रॅम हक्काचा....इलेक्ट्रो इंडिया...!



Scanned with OKEN Scanner

Date - 24/07/23

TRAINING CERTIFICATE

This is to certify that, Miss. Jyoti Mahadev Patil. of Degree 2nd yr Instrumentation & Control Engg. from the College PVPIT Budhgaon has completed Industrial Training in Electro India Sangli in the Period of 27 June. 2023 to 11 July. 2023. According to this she completed 2 weeks training.

In the training period we found her a sincere, honest, hardworking, dedicated trainee with a professional attitude and very good job knowledge. In this duration we gave her training of all types of weighing machines in two sections namely hardware section and software section . We found her work satisfactory because of her sincerity, dedication and hard work.

We have found her to be a self starter who is new invention view. We wish her all the best and success in future career.

For Electro-India

(Authorized Signatory)



आपला प्रत्येक ग्रॅम हक्काचा....इलेक्ट्रो इंडिया...!



MANUFACTURER, SALES & SERVICES OF
ELECTRONIC WEIGHING MACHINE
An ISO 9001:2008 Certified Company

LG ELECTRO INDUSTRIES

-  **CORPORATE OFFICE**
PLOT NO. 20, GHANSHYAM NAGAR, MADHAVNAGAR ROAD,
SANGLI - 416 416. (MAHARASHTRA) PH : 0233-2314242
-  Email : electroindia14@gmail.com || electroindiaindustries@gmail.com
-  Mobile : 9422506828, 9422409458 || www.electro-india.in

Date – 24/07/23

TRAINING CERTIFICATE

This is to certify that, **Miss. Sanika Prakash Magdum.** of Degree 2nd yr Instrumentation & Control Engg. from the College PVPIT Budhgaon has completed Industrial Training in Electro India Sangli in the Period of 27 June. 2023 to 11 July. 2023. According to this she completed 2 weeks training.

In the training period we found her a sincere, honest, hardworking, dedicated trainee with a professional attitude and very good job knowledge. In this duration we gave her training of all types of weighing machines in two sections namely hardware section and software section . We found her work satisfactory because of her sincerity, dedication and hard work.

We have found her to be a self starter who is new invention view. We wish her all the best and success in future career.

For Electro-India

(Authorized Signatory)



आपला प्रत्येक ग्रॅम हक्काचा....इलेक्ट्रो इंडिया...!



MANUFACTURER, SALES & SERVICES OF
ELECTRONIC WEIGHING MACHINE
An ISO 9001:2008 Certified Company

24

LG ELECTRO INDUSTRIES

- CORPORATE OFFICE**
PLOT NO. 20, GHANSHYAM NAGAR, MADHAVNAGAR ROAD,
SANGLI - 416 416. (MAHARASHTRA) PH : 0233-2314242
- Email : electroindia14@gmail.com || electroindiaindustries@gmail.com
- Mobile : 9422506828, 9422409458 || www.electro-india.in

Date – 24/07/23

TRAINING CERTIFICATE

This is to certify that, **Miss. Aishwarya Suresh Randive.** of Degree 2nd yr Instrumentation & Control Engg. from the College PVPIT Budhgaon has completed Industrial Training in Electro India Sangli in the Period of 27 June. 2023 to 11 July. 2023. According to this she completed 2 weeks training.

In the training period we found her a sincere, honest, hardworking, dedicated trainee with a professional attitude and very good job knowledge. In this duration we gave her training of all types of weighing machines in two sections namely hardware section and software section . We found her work satisfactory because of her sincerity, dedication and hard work.

We have found her to be a self starter who is new invention view. We wish her all the best and success in future career.

For Electro-India

(Authorized Signatory)



आपला प्रत्येक ग्रॅम हक्काचा....इलेक्ट्रो इंडिया...!



MANUFACTURER, SALES & SERVICES OF
ELECTRONIC WEIGHING MACHINE
An ISO 9001:2008 Certified Company

LG ELECTRO INDUSTRIES

- 📍 **CORPORATE OFFICE**
PLOT NO. 20, GHANSHYAM NAGAR, MADHAVNAGAR ROAD,
SANGLI - 416 416. (MAHARASHTRA) PH : 0233-2314242
- ✉ Email : electroindia14@gmail.com || electroindiaindustries@gmail.com
- 📞 Mobile : 9422506828, 9422409458 || www.electro-india.in

Date – 24/07/23

TRAINING CERTIFICATE

This is to certify that, **Miss. Poonam Anil Magdum.** of Degree 2nd yr Instrumentation & Control Engg. from the College PVPIT Budhgaon has completed Industrial Training in Electro India Sangli in the Period of 27 June. 2023 to 11 July. 2023. According to this she completed 2 weeks training.

In the training period we found her a sincere, honest, hardworking, dedicated trainee with a professional attitude and very good job knowledge. In this duration we gave her training of all types of weighing machines in two sections namely hardware section and software section . We found her work satisfactory because of her sincerity, dedication and hard work.

We have found her to be a self starter who is new invention view. We wish her all the best and success in future career.

For Electro-India



(Authorized Signatory)



आपला प्रत्येक ग्रॅम हक्काचा....इलेक्ट्रो इंडिया...!

-  **CORPORATE OFFICE**
PLOT NO. 20, GHANSHYAM NAGAR, MADHAVNAGAR ROAD,
SANGLI - 416 416. (MAHARASHTRA) PH : 0233-2314242
-  Email : electroindia14@gmail.com || electroindiaindustries@gmail.com
-  Mobile : 9422506828, 9422409458 || www.electro-india.in

Date - 24/07/23

TRAINING CERTIFICATE

This is to certify that, **Mr. Saksham Sunil Dhere.** Of Degree 2nd yr Instrumentation & Control Engg. from the College PVPIT Budhgaon has completed Industrial Training in **Electro India Sangli** in the Period of **27 June.2023 to 11 July.2023.** According to this he completed **2 Weeks** training.

In the training period we found him a sincere, honest, hardworking, dedicated trainee with a professional attitude and very good job knowledge. In this duration we gave him training of all types of weighing machines in two sections namely hardware section and software section . We found him work satisfactory because of his sincerity, dedication and hard work.

We have found him to be a self starter who is new invention view. We wish him all the best and success in future career.

For Electro-India

(Authorized Signatory)



आपला प्रत्येक ग्रॅम हक्काचा....इलेक्ट्रो इंडिया...!



श्री दूधगंगा वेदगंगा

सहकारी साखर कारखाना लि., बिद्री
(मौनीनगर), ता. कागल, जि. कोल्हापूर - ४१६ २०८ (महाराष्ट्र)
फोन फॅक्सटरी: (०२३२५) २५४९२२ ते २५४९२६ फॅक्स २५४९७२
कोल्हापूर ऑफिस राधाकृष्ण मंदिराजवळ, शाहपुरी २ री गल्ली,
कोल्हापूर, (०२३१) २६६९५५७८, २६६०४४९
E-mail : klp_bidnsgri@rediffmail.com

SHRI DUDHGANGA VEDGANGA

SAHAKARI SAKHAR KARKHANA LTD., BIDRI.
(MOUNINAGAR), TAL. KAGAL, DIST. KOLHAPUR - 416 208 (MAHARASHTRA)
PH. BIDRI EXCH.: (02325) 254922 TO 254926 FAX 254972
KOLHAPUR OFFICE: NEAR RADHAKRISHNA MANDIR, SHAMUPURI 2ND LANE, KOLHAPUR
PH.: (02321) 2661573 2660449 E-mail : klp_bidnsgri@rediffmail.com

31

Ref No: LWO/97/370

Date 27/2/2023

TO...

It is hereby certified that Mr. Pramod Dattaray Patil Working as Trainee Instrument Engineer in our factory.

During his tenure, we found him sincere, hard working & efficient. We wish all success in his future endeavours.

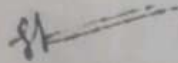
(S. A. More)
Labour officer

Place - Bidri
Date - 27-02-2023

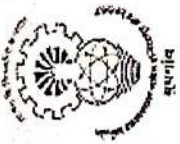

Dr. Vasantraodada Patil Shetkari Shikshan Mandal's
P.V.P. INSTITUTE OF TECHNOLOGY, BUDHGAON
INSTRUMENTATION ENGINEERING DEPARTMENT

Project Phase - II Evaluation

**Year 2022-23 Class Final Year BTech
Subject : Project Part - II (BTIEP803)**

Sr. No	Ref No	Name of Guide	Sr	Name of Student	Title of Project	Industry (Internship)	Dates
B1.1	I-01	Prof S S Patil			EV Battery Monitoring System		
			11	Nandre Pratik Adinath			
			17	Dalvi Sanket Dilip			
			26	Yelavikar Pavan Janardhan			
			31	Kothawale Aashpak Iqbal			
	32	Patil Swapnil Tukaram					
B1.2	I-02	Prof S S Sutar			PLC Base Sprinkler Irrigation System		
			14	Bhosale Ninad Ramdas		Ganlaxmi Industries	1.2.23 - 31.4.23
			20	Kupwade Mayuri Ravindra		Ganlaxmi Industries	1.2.23 - 31.4.23
			21	Patil Nikita Anil		Ganlaxmi Industries	1.2.23 - 31.4.23
			22	Patil Aboli Prakash		Ganlaxmi Industries	1.2.23 - 31.4.23
	29	Desai Prafulla Prakash	Ganlaxmi Industries	1.2.23 - 31.4.23			
B1.3	I-03	Prof S S Patil			Advanced Agriculture		
			15	Mahanur Asawari Sambhaji		Pragati Industries	1.2.23 - 1.05.23
			18	Hulle Sourabh Shital		DTAP	13.02.23 - 31.5.23
			19	Jayappa Suraj Rajaram		DTAP	— —
	23	Patil Aviraj Sambhaji	DTAP	DTAP	— —		

B2.1	I-04	Prof P M Magdum	28	Pawaskar Vellari Sushil	Biometric Voting Machine	Pragati Industries	1.2.23 - 1.5.23		
			1	Pawar Pratik Prakash					
			5	Patil Shubham Jaysing					
			6	Mali Vishal Sanjay					
			8	Nalawade Vishal Kakaso			IOSCAPE	20.2.23 - 9.3.23	
			9	Kulkarni Parag Harshal			TPM DEPOT	15.3.23 - 20.5.23	
B2.2	I-05	Prof V L Karade	2	Magar Harshad Manik		IOT Based Home Automation			
			3	Nalawade Ajinkya Dattatray					
			4	Mohite Nikita Pradip					
			7	Shaikh M M					
			10	Patil Ruturaj Sadashiv			IND IOT Automation LLP	15.2.23 - 10.6.23	
B2.3	I-06	Prof R S More			Automatic pesticide spraying robot				
			12	Koparde Rushikesh Dipak			IND IOT Automation LLP	15.2.23 - 10.6.23	
			13	Patil Sudarshan Shahaji			IND IOT Automation LLP	15.2.23 - 10.6.23	
			24	Waske Ganesh Mohan			IND IOT Automation LLP	15.2.23 - 10.6.23	
			25	Suryawanshi Varad Sunil			DSD Security Services	18.2.23 - 18.4.23	
			30	Rajopadhye Shubham Vasudev			IND IOT Automation LLP	15.2.23 - 10.6.23	
B2.4	I-07	Prof V L			Hydraulic valve testing				
			16	Pawar Vaishnavi Sanjay					
			27	Dhere Dasharath Mahadev			Vapco Engineering Pvt Ltd	1.2.23 - 31.4.23	
			33	Mane Vidnyan Prakash					
			34	Patil Prathmesh					

No. of Students	Industry	Date
5	Ganlaxmi Industries	1.2.23 - 31.4.23
1	IOSCAPE	20.2.23 - 9.3.23
1	TPM DEPOT	15.3.23 - 20.5.23
5	IND IOT Automation LLP	15.2.23 - 10.6.23
1	DSD Security Services	18.2.23 - 18.4.23
1	Vapco Engineering Pvt Ltd	1.2.23 - 31.4.23
3	DTAP	13.2.23 - 31.5.23
2	Pragati Industries	1.2.23 - 31.5.23
19	Total Internship	

 Mrs. S. S. Sutar

 H.O.D.
 Instrumentation Engineering (Degree)



B1.2

22

Ganalaxmi Industries

Key solutions with Quality, Technology and Reliability

539/6B, Ganalaxmi, Subhashnagar, Behind Alakhwani, Kolhapur road, Sangli-416416
Website:- www.ganalaxmiindustries.com Email id:- ganalaxmiindustries@gmail.com
Contact No. 9284568266, 9175809110 GSTIN - 27ENPP9881E1Z5

Certificate of Internship

This Internship Program letter is certify to Miss. Aboli P. Patil for her outstanding completion of internship program at Ganalaxmi Industries, Sangli. For the role of Graduate Engg. Trainee under guidance of Mr. Abhishek G. Phadke. From Date 01-02-2023 To 31-04-2023.

During her tenure service we found her character and service satisfactory. We wish her good luck in all his future endeavors.

Best Regards.

Date of Issue:- 2-05-2023

Place:- Sangli, 416416.



Ganalaxmi Industries

Director



B1.2
(21)

Ganalaxmi Industries

Key solutions with Quality, Integrity and Reliability

539/6B, Ganalaxmi, Subhashnagar, Behind Akashwani, Kolhapur road, Sangli-416416
Website:- www.ganalaxmiindustries.com Email id:- ganalaxmiindustries@gmail.com
Contact No. 9284566266, 9175809110 GSTIN :- 27ENNPP9881E1Z5

Certificate of Internship

This Internship Program letter is certify to Miss. Nikita A. Patil for her outstanding completion of internship program at Ganalaxmi Industries, Sangli. For the role of Graduate Engg. Trainee under guidance of Mr. Abhishek G. Phadke. From Date 01-02-2023 To 31-04-2023.

During her tenure service we found her character and service satisfactory. We wish her good luck in all his future endeavors.

Best Regards.

Date of Issue:- 2-05-2023

Place:- Sangli, 416416.



Ganalaxmi Industries

Director



B.2
14

Ganalaxmi Industries

Key solutions with Quality, Integrity and Reliability

539/6B, Ganalaxmi, Subhashnagar, Behind Akashwani, Kolhapur road, Sangli-416416
Website:- www.ganalaxmiindustries.com Email id:- ganalaxmiindustries@gmail.com
Contact No. 9284566266, 9175809110 GSTIN :- 27ENNPP9881E1Z5

Certificate of Internship

This Internship Program letter is certify to Mr. Ninad R. Bhosale for his outstanding completion of internship program at Ganalaxmi Industries, Sangli. For the role of Graduate Engg. Trainee under guidance of Mr. Abhishek G. Phadke. From Date 01-02-2023 To 31-04-2023.

During his tenure service we found his character and service satisfactory. We wish him good luck in all his future endeavors.

Best Regards.

Date of Issue:- 2-05-2023

Place:- Sangli, 416416.



Ganalaxmi Industries

Director



GANALAXMI
INDUSTRIES

Ganalaxmi Industries

Key solutions with Quality, Integrity and Reliability

539/6B, Ganalaxmi, Subhashnagar, Behind Akashwani, Kolhapur road, Sangli-416416
Website:- www.ganalaxmiindustries.com Email id:- ganalaxmiindustries@gmail.com
Contact No. 9284566266, 9175809110 GSTIN :- 27ENPP9881E1Z5

B.1.2
29

Certificate of Internship

This Internship Program letter is certify to Mr. Prafulla P. Desai for his outstanding completion of internship program at Ganalaxmi Industries, Sangli. For the role of Graduate Engg. Trainee under guidance of Mr. Abhishek G. Phadke. From Date 01-02-2023 To 31-04-2023.

During his tenure service we found his character and service satisfactory. We wish him good luck in all his future endeavors.

Best Regards.

Date of Issue:- 2-05-2023

Place:- Sangli, 416416.



Ganalaxmi Industries

Director



B1.2

20

Ganalaxmi Industries

Key solutions with Quality, Integrity and Reliability

539/60, Ganalaxmi, Subhashnagar, Behind Akashwani, Kolhapur road, Sangli-416416
Website:- www.ganalaxmiindustries.com Email Id:- ganalaxmiindustries@gmail.com
Contact No. 9284566266, 9175809110 GSTIN :- 27ENPP9881E125

Certificate of Internship

This Internship Program letter is certify to Miss. Mayuri R. Kupwade for her outstanding completion of internship program at Ganalaxmi Industries, Sangli. For the role of Graduate Engg. Trainee under guidance of Mr. Abhishek G. Phadke. From Date 01-02-2023 To 31-04-2023.

During her tenure service we found her character and service satisfactory. We wish her good luck in all his future endeavors.

Best Regards.

Date of Issue:- 2-05-2023

Place:- Sangli, 416416.



Ganalaxmi Industries

Director



AN ISO 9001:2008 CERTIFIED COMPANY

INDUSTRIES

Plot No.134, Industrial Estate, Sangli - 416 416. (Mah.) India
Phone - (0233) 2310942 / 43 Fax : 2310941, 9423868898 / 99
Web : <http://www.centrifugalpumpindia.in>
Email : pragatisangli@gmail.com info@centrifugalpumpindia.in

Manufacturers & Suppliers of : Pumps & Spares, Mill Spares, V. T. Pump Spares, Ferrous & Non Ferrous Castings.

Certificate of Internship

This Internship Program letter is certify to Miss.Asawari S Mahanur for her outstanding completion of internship program at PRAGATI Industries, Sangli. For the role of Graduate Engg. Trainee under guidance of Mr.Pratik M Patil From Date 01-02-2023 To 31-04-2023.

During her tenure service we found her character and service satisfactory. We wish her good luck in all his future endeavors.

Best Regards.

Date of Issue:- 1-06-2023

Place:- Sangli,416416.



Date: 14.06.2023

TO WHOM SO EVER IT MAY CONCERN

This is to certify that Mr. Saurabh Hulle has successfully completed Internship / Training on Industrial Automation for the fulfillment of curriculum of Bachelor of Technology in Instrumentation Engineering from Padmabhooshan Vasantraodada Patil Institute of Technology, Budhgaon, Sangli from 13th Feb 2023 to 31st May 2023.

Best Regards,

Ditap-V Automation Pvt. Ltd.

Sneha Jagtap
HRD

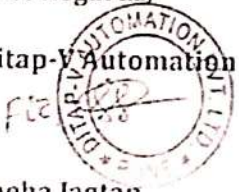

813
19

Ditap-V

Ditap V Automation Pvt Ltd
Kondhambhata-5, Mysuru-Karnataka

Office:
B No. 9/12, 9th St, HRD
1st Floor, Kondhambhata
Mysuru-575 002, Karnataka
India | Tel: 98452 27275

Branch:
B No. 9/12, 9th St
1st Floor, Kondhambhata
Mysuru-575 002, Karnataka
India | Tel: 98452 27275

Date: 14.06.2023

TO WHOM SO EVER IT MAY CONCERN

This is to certify that Mr. Saraj Jayappa has successfully completed Internship / Training on Industrial Automation for the fulfillment of curriculum of Bachelor of Technology in Instrumentation Engineering from Padmabhushan Vasanthrambada Peta Institute of Technology, Bangalore, from 13th Feb 2023 to 31st May 2023.

Best Regards,

Ditap V Automation Pvt. Ltd.



Sneha Jagtap
HRD

Date: 14.06.2023

TO WHOM SO EVER IT MAY CONCERN

This is to certify that Mr. Aviraj Patil has successfully completed Internship / Training on Industrial Automation for the fulfillment of curriculum of Bachelor of Technology in Instrumentation Engineering from Padmabhooshan Vasandraodada Patil Institute of Technology, Budhgaon, Sangli from 4th March 2023 to 31st May 2023.

Best Regards,

Ditap-V Automation Pvt. Ltd.



Sneha Jagtap
HRD



AN IOS 9001:2008 CERTIFIED COMPANY

INDUSTRIES

Plot No. 134, Industrial Estate, Sangli - 416 416. (Mah.) India
Phone - (0233) 2310942 / 43 Fax : 2310941, 9423868898 / 99
Web : <http://www.centrifugalpumpindia.in>
Email : pragatisangli@gmail.com info@centrifugalpumpindia.in

B1.3
28

Manufacturers & Suppliers of : Pumps & Spares, Mill Spares, V. T. Pump Spares, Ferrous & Non Ferrous Castings.

Certificate of Internship

This Internship Program letter is certify to Miss.Vallari S Pawaskar for her outstanding completion of internship program at PRAGATI Industries, Sangli. For the role of Graduate Engg. Trainee under guidance of Mr.Pratik M Patil From Date 01-02-2023 To 31-04-2023.

During her tenure service we found her character and service satisfactory. We wish her good luck in all his future endeavors.

Best Regards.

Date of Issue:- 1-06-2023

Place:- Sangli,416416.

Pratik





IOSCAPE

Edge Sensing & Cloud Control



ioscape Intelitech Private Limited
Dhavalgri, Plot No 23B, Sr No 3616,
Lakshminagar, Kupwad Road,
Sangli Maharashtra India 416416



+91-233-3553237



support@ioscape.io
<https://ioscape.io>

Date: 10th March 2023

TO WHOMSOEVER IT MAY CONCERN

This is to certify that Mr. Vishal Kakaso Nandiwale, B.TECH. INSTRU student of P.V.P. INSTITUTE OF TECHNOLOGY, BUDHGAON has successfully completed training in our organization from 20th Feb 2023 to 9th March 2023. The training consisted of the basics of electronics, building circuits, and simulation of circuits.

We wish Vishal all the best in his future Endeavours.

Padmaraj

Padmaraj Jain
Co-Founder and Director,
ioscape Intelitech Private Limited



Date: 09.06.2023

EXPERIENCE CERTIFICATE

To whomsoever this may concern

This is to certify Mr. Parag Harshal Kulkarni was working as Trainee Engineer during the period starting from 15th March 2023 to 20th May 2023 in our company.

During this tenure his performance was satisfactory.

We wish all the success in her future endeavor

This certificate has been issued upon request from Parag Harshal Kulkarni

For TPM DEPOT

Shrikant Gujjar
Sr HR Executive



IND-IoT Automation LLP

IoT • Industrial IoT • Automation • IoT Product Development

Ref: Training/2324/17

Date:12/06/2023

To whomsoever, it may concern,

This is to certify that Mr. Sudarshan patil from PVPIT, Budhgson
(B.Tech Instru.) has successfully completed Internship in our company.

The tenure of Internship was (15/02/2023 to 10/06/2023)

During the Internship tenure, he was punctual, hardworking, and inquisitive.

We wish him success in his future endeavors.

Mr. Rutvik Milind Sidhaye
Director - Designated Partner
IND-IoT Automation LLP



Mr. Vinay M. Honrao
Director - Designated Partner
IND-IoT Automation LLP

Office Address
B-1, Samarth Icon, Opp SBI
Vishrambag, Sangli -416415

Reg. Address
H No 154, Subhashnagar,
Miraj-416410

+919762463995 / +918600786380
Indiot.automation@gmail.com

IND-IoT Automation LLP

IoT • Industrial IoT • Automation • IoT Product Development

Ref: Training/2324/17

Date:12/06/2023

To whomsoever, it may concern,

This is to certify that Mr. Shubham Rajopadhye from PVPIT, Budhgaon
(B.Tech Instru.) has successfully completed Internship in our company.

The tenure of Internship was (15/02/2023 to 10/06/2023)

During the Internship tenure, he was punctual, hardworking, and inquisitive.

We wish him success in his future endeavors.



Mr. Rutvik Milind Sidhaye
Director - Designated Partner
IND-IoT Automation LLP



Mr. Vinay M. Honrao
Director - Designated Partner
IND-IoT Automation LLP

Office Address
B-1, Samarth Icon, Opp SBI
Vishrambag, Sangli -416415

Reg Address
H. No. 154, Subhashnagar,
Miraj-416410

+919762463995 / +918600786380
indiot.automation@gmail.com

B23
7

IND-IoT Automation LLP

IoT • Industrial IoT • Automation • IoT Product Development

Ref Training/2324/15

Date: 12/05/2023

To whomsoever, it may concern,

This is to certify that **Mr. Mahanmadilaj Shekh** from PVPIT, Budhgaon
(B.Tech Instru) has successfully completed Internship in our company
The tenure of Internship was (15/02/2023 to 10/06/2023)

During the Internship tenure, he was punctual, hardworking, and inquisitive.

We wish him success in his future endeavors.



Mr. Rutvik Milind Sidhaye
Director - Designated Partner
IND-IoT Automation LLP



Mr. Vinay M. Honrao
Director - Designated Partner
IND-IoT Automation LLP

Office Address
B-1, Samarth Icon, Opp SBI
Vishrambag, Sangli-416415

Reg. Address:
H No 154, Subhashnagar,
Miraj-416410

+919762463995 / +918600786380
indiotautomation@gmail.com

IND-IoT Automation LLP

IoT • Industrial IoT • Automation • IoT Product Development

Ref: Training/2324/17

Date:12/06/2023

To whomsoever, it may concern,

This is to certify that **Mr. Rushikesh Dipak Koparde** from PVPIT, Budhgaon (B.Tech Instru) has successfully completed Internship in our company.

The tenure of Internship was (15/02/2023 to 10/06/2023)

During the Internship tenure, he was **punctual, hardworking, and inquisitive.**

We wish him success in his future endeavors.

Mr. Rutvik Milind Sidhaye
Director - Designated Partner
IND-IoT Automation LLP



Mr. Vinay M. Honrao
Director - Designated Partner
IND-IoT Automation LLP

Office Address
B-1, Samarth Icon, Opp SBI
Vishrambag, Sangli -416415

Reg Address
H. No 154, Subhashnagar,
Miraj-416410

+919762463995 / +918600786380
indiot.automation@gmail.com

IND-IoT Automation LLP

IoT • Industrial IoT • Automation • IoT Product Development

Ref: Training/2324/17

Date:12/06/2023

To whomsoever, it may concern,

This is to certify that Mr. Ganesh wakshe from PVPIT, Budhgaon
(B.Tech Instru.) has successfully completed Internship In our company.

The tenure of Internship was (15/02/2023 to 10/06/2023)

During the Internship tenure, he was punctual, hardworking, and inquisitive.

We wish him success in his future endeavors.

Mr. Rutvik Milind Sidhaye
Director - Designated Partner
IND-IoT Automation LLP



Mr. Vinay M. Honrao
Director - Designated Partner
IND-IoT Automation LLP

Office Address
B-1, Samarth Icon, Opp SBI
Vishrambag, Sangli -416415

Reg Address:
H No 154, Subhashnagar,
Miraj-416410

+919762463995 / +918600786380
indiot.automation@gmail.com

B2.3

(25)

Reg. No.: II/15720/15 DT.1/1/2015

DSD

SECURITY SERVICES

9890488427, 9665510514
dsd9665@gmail.com

SHOP NO. 01, SHREE COMPLEX, S. T. COLONY, VISHRAMBAG, SANGLI.

Ref. No.: II/15720/23/ DT. 11/1/23

Date: 14/06/2023

Training Certificate

This is to certify that Mr. Varad Sunil Suryawanshi B.Tech student of PVPIT, Sangli has completed industrial training at our organization from 18-02-2023 TO 18-04-2023.

During this training we found him sincere and hard working. We wish him best luck for his future ventures.

DSD SECURITY SERVICES, SANGLI

Authorized Signatory

Date-14-06-2023



Place-Sangli

B 2-3p
27

Date: 20 Mar. 2023

TO WHOMSOEVER IT MAY CONCERN

This is to certify that Mr. Dasharath Mahadev Dhere has working with us from May 2022 to till date as Instrumentation Engineer in the project department of our organization.

He was highly motivated and hardworking. He worked sincerely at his tasks and did a very good job.

This certificate has been issued on his request for the educational purpose only.

Sincerely,
Vapco Engineers Pvt Ltd.

Solve

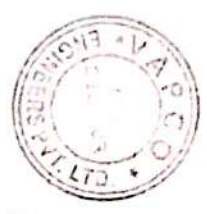



M/S. Khare Elec - Trans
MFG OF ALL TYPE OF TRANSFORMERS



3

CERTIFICATE

This is to certify that, **MR.MALI AJAY PANDURANG** student of T.Y, Instru from the Padmabhushan Dr. Vasantdada Patil Institute of Technology, Budhgaon, Dist. Sangli has visited our factory from 23/09/2022 to 15/10/2022 for Vocational In plant Training.

During his training period she found regular & sincere.

This certificate issued on her request.

Date: 15/10/2022

Place - Tasgaon

Authorized Signatory
Khare Elec-Trans



M/S. Khare Elec - Trans
MFG OF ALL TYPE OF TRANSFORMERS



(4)

CERTIFICATE

This is to certify that, **MR. LOHAR ANIKET DADASO**, student of T.Y, Instru from the Padmabhushan Dr. Vasantdada Patil Institute of Technology, Budhgaon, Dist. Sangli has visited our factory from 23/09/2022 to 15/10/2022 for Vocational in plant Training.

During his training period she found regular & sincere.

This certificate issued on her request.

Date: 15/10/2022

Place - Tasgaon

Authorized Signatory
Khare Elec-Trans



GANALAXMI
INDUSTRIES

CERTIFICATE

This certificate is presented to

Arjun Rama Honakande

Has successfully completed " 4 week's Industrial Training " on
PLC, SCADA & HMI from 18 may 2023 to 18 June 2023 Organised
by Ganalaxmi Industries and PVPIT BUDHGAON.

Ganalaxmi Industries
Email- ganalaxmiindustries@gmail.com
Visit us- www.ganalaxmiindustries.com
Contact No. 9284566266, 9175809110



Authorized Sign



Reg.No. SAN/TGN/AGR/(M)1751-2004/2005 Dt. 24-08-2004

GRAPE CITY WINERY SAHAKARI SANSTHA LTD., SAVLAJ

Gat No. 1366, Waifale Road, A/p. Savlaj Tal. Tasgaon Dist. Sangli
Cell : 9970210999,9960619291 E-mail : grapecity2004@gmail.com

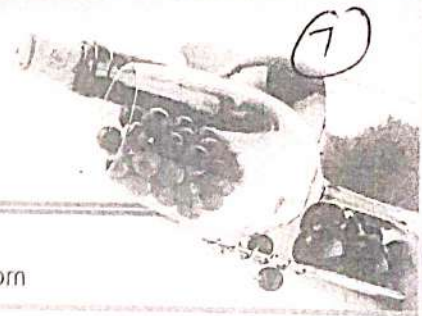

FOUNDER
Hon. R. R. PATIL

Date :



CERTIFICATE OF INTERNSHIP

This internship program certificate is proudly awarded to

Miss. Divya Nagnath Kumbhar

For him/her outstanding completion of the internship program at firm M/S Grape City Winery Sahakari Sanstha LTD Savalaj for the role of Bottling Machine Technician under the guidance of Mr. Krishna Shinde from date 01/09/2022 to 15/09/2022. He/She is found to be hardworking, sincere and diligent. We wish him/her all the best for future.

CEO

GRAPE CITY WINERY SAHAKARI
SANSTHA LTD; SAVLAJ(SANGLI)
TAL.TASGAON, DIST.SANGLI

Program Manager



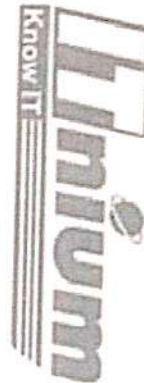

Certificate of Training

NIMISHA NARESH PHADNIS

From PVPIT, Budhgaon, has successfully completed 1 Month Internship Program at ITrium Sangli during 25th Dec 2022 to 24th Jan 2023.

The training consisted of AWS services like EC2,S3,Cloudwatch,Route53,VPC,Lambda,EBS,etc.

We wish her all the best for future endeavours.

Registration No : UDYAM-MH-29-0020285 / 108057532103



ISO - QMS/SA2930 / ISO CSCM B1719

Date of Certification: 31th Jan 2023

DIRECTOR
Nitesh Takale



M/S. Khare Elec - Trans
MFG OF ALL TYPE OF TRANSFORMERS



13

CERTIFICATE

This is to certify that, **MISS. PAWAR SUPRIYA MAHESH**, student of T.Y, Instru from the Padmabhushan Dr. Vasantdada Patil Institute of Technology, Budhgaon, Dist. Sangli has visited our factory from 23/09/2022 to 15/10/2022 for Vocational in plant Training.

During her training period she found regular & sincere.

This certificate issued on her request.

Date: 15/10/2022

Place - Tasgaon

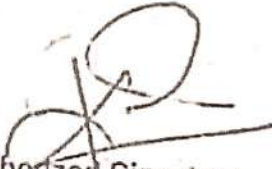
Authorized Signatory
For Khare Elec-Trans



Prop. D. C. Patil

PATIL DAIRY PRODUCTS

□ A/p. Malwadi (Bhilwadi). Tal. Palus, Dist. Sangli
□ Mob.: 96 89 88 38 02 □ Web : www.patildairy.com
□ E-mail : patildairy007@gmail.com

पा./डे./प्रॉ./जा.क्र. 70-2022-23

दिनांक 21/02/2023

Roll No: 14

Certificate

This is to certify that Mr. Tushar Shankar Pawar, B.Tech III Student from Department of Instrumentation and Control, P.V.P.I.T Budhgaon have successful completed his project on "Industrial Training" in our Organization from 06.02.2023 to 18.02.2023.

During the project work he has shown keen interest and found to be sincere and hard working.

We wish his every success in his future endeavors. This certificate is issued on his request.

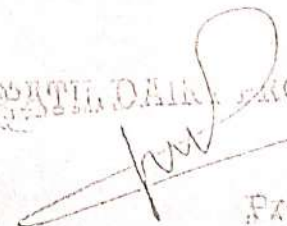
PATIL DAIRY PRODUCTS

Proprietor



M/S. Khare Elec - Trans
MFG OF ALL TYPE OF TRANSFORMERS



15

CERTIFICATE

This is to certify that, MR.MALI VINAYAK BALASAHEB student of T.Y, Instru from the Padmabhushan Dr. Vasantdada Patil Institute of Technology, Budhgaon, Dist. Sangli has visited our factory from 23/09/2022 to 15/10/2022 for Vocational In plant Training.

During his training period she found regular & sincere.

This certificate issued on her request.

Date: 15/10/2022

Place - Tasgaon

Authorized Signatory
Khare Elec-Trans



M/S. Khare Elec - Trans
MFG OF ALL TYPE OF TRANSFORMERS



16

CERTIFICATE

This is to certify that, **MR.KOLI ANIKET BALASAHEB** student of T.Y, Instru from the Padmabhushan Dr. Vasantdada Patil Institute of Technology, Budhgaon, Dist. Sangli has visited our factory from 23/09/2022 to 15/10/2022 for Vocational In plant Training.

During his training period she found regular & sincere.

This certificate issued on her request.

Date: 15/10/2022

Place - Tasgaon

Authorized Signatory
Khare Elec-Trans



**Power Control
Electro Systems Pvt.Ltd.**

E-32, M.I.D.C., Kupwad, Sangli. 416 436. INDIA
Phone : +91 - 233 - 2645630, 2645640
E-mail : sales@pcsystems.in, admin@pcsystems.in
Web : www.pcsystems.in
CIN No. : U32102PN2006PTC128730

Ref:-PCES/PRO/2022-23/155.

Date :-

Certificate

This is to certify that **Mr. Rushabh C. Shinde** has worked in Assembly shop as a Electrical Engineer at **Power Control Electro Systems Pvt. Ltd.** Plot No-E-32, M.I.D.C., Kupwad, Sangli, Maharashtra. 416436.

From Dated 01/01 /2022 to Until today.

We found him sincere, hardworking and technically sound. He worked as a part of team in Railway Panel Division during his tenure. We take opportunity to wish all the best for his future.

For, Power Control Electro Systems Pvt. Ltd.

Mr.Pathak C. S.

Incharge

Railway Division

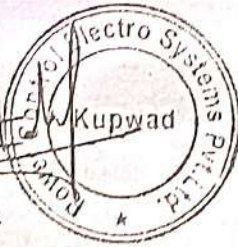

22

TO WHOMSOEVER IT MAY CONCERN

This is to certify that Mr. Ashish R. Chavan, a BTech student of P.V.P.I.T. Sangli has successfully completed Internship under "Internship Program" from Magnum Lubricants India Pvt. Ltd., Mumbai from 10 March 2023 to April 2023.

Ashish R. Chavan has shown good commitment to the assigned work and has displayed keen interest in learning new concepts. He has contributed ardently in the assigned activities throughout his training with us.

We wish him All The Very Best for her professional career journey.

Thanking you,



Yours faithfully,



Magnum Lubricants India Pvt. Ltd.

23

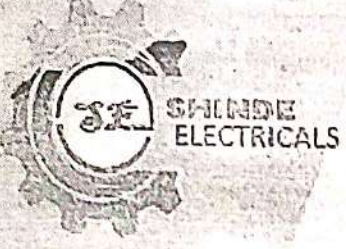

Shinde Electricals

353, Radhakrushna Vasahal, Sangli 416 416. Cell : 9890952790 /
9370701451 Email : shindeanil2575@gmail.com

CERTIFICATE

This is certify that, Mr. Pavan Babu Sakate. Student of T.Y. Instrumentation Dpt. From the
PVPIT, Budhgaon. Dist. - Sangli. Has visited our office from 02/05/2023 to 17/05/2023 for
vocational in plant Training .During his training period he found regular & sincere.

This certificate issued on her request.

Yours Faithfully,

शिंदे इलेक्ट्रिकल्स
गाळा नं. १०, टिळक चौक,
सांगली. Mob. 9890952790

Shinde Electricals



Shinde Electricals

353, Radhakrushna Vasahat, Sangli 416 416. Cell : 9890952790 /
9370701451 Email : shindeanil2575@gmail.com

CERTIFICATE

This is certify that, Mr. Kaustubh Sudhir Ghongadi. Student of T.Y. Instrumentation Dpt.

From the PVPIT, Budhgaon. Dist. - Sangli. Has visited our office from 02/05/2023 to

17/05/2023 for vocational in plant Training .During his training period he found regular &
sincere.

This certificate issued on her request.

Yours Faithfully,

शिंदे इलेक्ट्रिकल्स

गाळा नं. १०, टिळक चौक,
सांगली. Mob. 9390952790

Shinde Electricals



Prop. D. C. Patil

PATIL DAIRY PRODUCTS

- A/p. Malwadi (Bhilwadi). Tal. Palus, Dist. Sangli
- Mob.: 96 89 88 38 02 □ Web : www.patildairy.com
- E-mail : patildairy007@gmail.com

पा./डे./प्रॉ./जा.क्र. 70-2022-23

दिनांक 21/02/2023

Roll no : 28

Certificate

This is to certify that Mr. Manish Mahesh Shete, B.Tech III Student from Department of Instrumentation and Control, P.V.P.I.T Budhgaon have successful completed his project on "Industrial Training" in our Organization from 06.02.2023 to 18.02.2023.

During the project work he has shown keen interest and found to be sincere and hard working.

We wish his every success in his future endeavors. This certificate is issued on his request.

PATIL DAIRY PRODUCTS

Proprietor



Reg.No. SAN/TGN/AGR/(M)1751-2004/2005 Dt. 24-08-2004

GRAPE CITY WINERY SAHAKARI SANSTHA LTD., SAVLAJ

Gat No. 1366, Waifale Road, A/p. Savlaj Tal. Tasgaon Dist. Sangli
Cell : 9970210999,9960619291 E-mail : grapecity2004@gmail.com

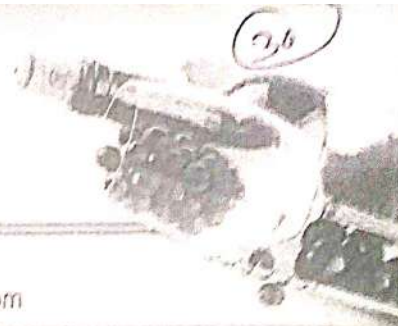

FOUNDER
Hon. R. R. PATIL

Date :



CERTIFICATE OF INTERNSHIP

This internship program certificate is proudly awarded to

Miss. Sanika Appaso Pailwan

For him/her outstanding completion of the internship program at firm M/S Grape City Winery Sahakari Sanstha LTD Savalaj for the role of Bottling Machine Technician under the guidance of Mr. Krishna Shinde from date 01/09/2022 to 15/09/2022. He/She is found to be hardworking, sincere and diligent. We wish him/her all the best for future.

CEO

GRAPE CITY WINERY SAHAKARI
SANSTHA LTD; SAVLAJ(SANGLI)
TAL.TASGAON, DIST.SANGLI

Program Manager



CERTIFICATE

This is to certify that the project report entitled “**Brain Tumor Detection On MRI Images And consultant system**” submitted by **Miss.Namrata M. Sawant, Mr. Prathamesh D. Patil, Miss.Pranjal A. Kandgoankar, Miss. Samruddhi A. Mane, Miss.Anushka T. Rupnar** for the partial fulfilment of the requirement for the award of degree of **Bachelor of Technology in Computer Science & Engineering** to the **DBATU**.

This report is a record of students’ teamwork carried out by them under my supervision and guidance.

Date: / /2023

Place: Budhgoan

Mrs. D.V. Patil
Guide

Dr. B.S. PATIL
Head of Department

Dr. D.V. GHEVDE
Principal

STUDENT PLACEMENT PREDICTION PORTAL

A Report submitted to

Dr. BABASAHEB AMBEDKAR

TECHNOLOGICAL UNIVERSITY, LONERE

in partial fulfilment for the Degree of

BACHELOR OF TECHNOLOGY

In

COMPUTER SCIENCE AND ENGINEERING

UNDER THE GUIDANCE OF

Mrs. N. R. Chaus



**PADMABHOOSHAN VASANTRAODADA PATIL
INSTITUTE OF TECHNOLOGY, BUDHGAON**

JUNE, 2023

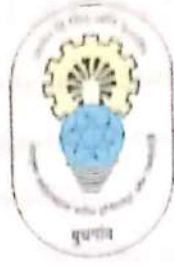

**PADMABHOOSHAN VASANTRAODADA PATIL INSTITUTE OF
TECHNOLOGY, BUDHGAON**

Department of Computer Science & Engineering

CERTIFICATE

This is to certify that the project report entitled

STUDENT PLACEMENT PREDICTION PORTAL

submitted by

Name	Roll No.	PRN
Prajwal Pandurang Shinde	4055	1962691242002
Omkar Sushil Dubal	4066	1962691242036
Amit Ashok Barge	4054	1962691242018
Satyajit Sunilrao Dubal	4056	1962691242075
Kedar Ashok kumbhar	4073	1962691242076

to **Dr. BABASAHEB AMBEDKAR TECHNOLOGICAL
UNIVERSITY, LONERE**, in partial fulfilment for the award of the degree of **B. Tech
in Computer Science and Engineering** is a *bonafide* record of project work carried
out by him/her under my/our supervision. The contents of this report, in full or in parts,
have not been submitted to any other Institution or University for the award of any
degree or diploma.

Mrs. N. R. Chaus
Guide

Mr. B. S. Patil
HOD
(DEPT-CSE)

Mr. D. V. Ghevde
Principal

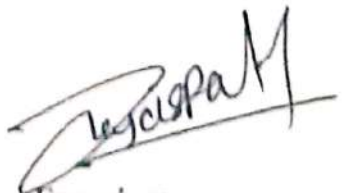
Examiner

DO CONNECT

A Report submitted to

**Dr. BABASAHEB AMBEDKAR TECHNOLOGICAL
UNIVERSITY, LONERE**

In partial fulfillment for the Degree of

BACHELOR OF TECHNOLOGY

**Computer Science Engineering
BY**

NAME	PRN NO.	ROLL NO.
SARVESH PRATAP PATIL	1962691242043	4039
SHUBHAM SUDHAKAR AWATE	1962691242070	4043
TUSHAR BABASO THOMBARE	1962691242005	4042



UNDER THE GUIDANCE OF
Mrs. N.R.Chauhan

**PADMABHOOSHAN VASANTRAODADA
PATIL INSTITUTE OF TECHNOLOGY,
BUDHGAON**

JUNE, 2023



**PADMABHOOSHAN VASANTRAODADA PATIL INSTITUTE
OF TECHNOLOGY, BUDHGAON**

Department of COMPUTER SCIENCE Engineering

CERTIFICATE

This is to certify that the project report entitled

DO CONNECT

Submitted By

Name	Roll No.	PRN
Sarvesh Pratap Patil	4039	1962691242043
Shubham Sudhakar Awate	4043	1962691242070
Tushar Babaso Thombare	4042	1962691242005

To Dr. BABASAHEB AMBEDKAR TECHNOLOGICAL

UNIVERSITY, LONERE, in partial fulfillment for the award of the degree of **B. Tech in Computer Science and Engineering** is a record of project work carried out by him/her under my/our supervision. The contents of this report, in full or in parts, have not been submitted to any other Institution or University for the award of any degree or diploma.

Mrs. N. R. Chaus
Guide

Mr. B. S. Patil
HOD
(DEPT-CSE)

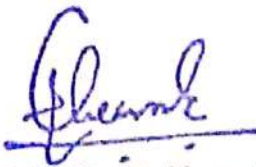
Mr. D. V. Ghewde
Principal

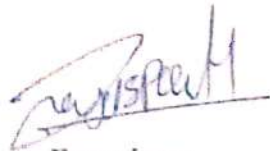
Examiner

Hospital Management System

A Report submitted to

Dr. BABASAHEB AMBEDKAR TECHNOLOGICAL UNIVERSITY, LONERE

in partial fulfilment for the Degree of

BACHELOR OF TECHNOLOGY

In

Computer Science & Engineering

Mrs. Pallavi Ashok Khemalapure

Mrs. Akanksha Mohan Sawant

Mrs. Santhosimata Manjunath Ilager

Mr. Arjun Kantappa Kawade

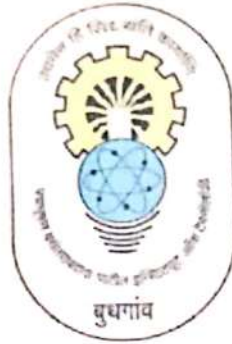

UNDER THE GUIDANCE OF

Mrs. M. S. Mane.

**PADMABHOOSHAN VASANTRAODADA PATIL INSTITUTE
OF TECHNOLOGY, BUDHGAON**

DECEMBER , 2022-23

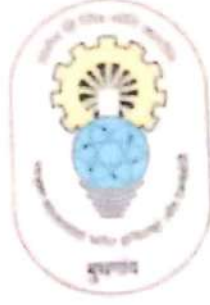

**PADMABHOOSHAN VASANTRAODADA PATIL INSTITUTE OF TECHNOLOGY,
BUDHGAON**

Department of Computer Science & Engineering

CERTIFICATE

This is to certify that the project report entitled

Hospital Management System

submitted by

Name	PRN
Pallavi Ashok Khemalpure	2062691242013
Akanksha Mohan Sawant	1962691242061
Santhosimata Manjunath Ilager	1962691242015
Arjun Kantappa Kawade	1962691242026

To Dr. BABASAHEB AMBEDKAR TECHNOLOGICAL UNIVERSITY, LONERE, in partial fulfillment for the award of the degree of B. Tech in Computer Science & Engineering is a Bonafide record of project work carried out by him/her under my/our supervision. The contents of this report, in full or in parts, have not been submitted to any other Institution or University for the award of any degree or diploma.

Mrs.M.S.Mane

Guide

Prof.B.S.Patil

Head of Department

Dr.D.V.GHEVDE

Principal

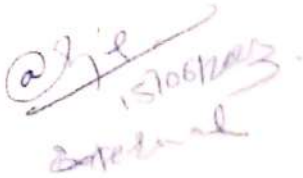
15/06/2023

Dr. Babasaheb Ambedkar Technological University, Lonere

**A
Project Report on**

**“A Computer vision based elderly people monitoring and
safety system”**

Submitted in partial fulfillment of the requirement for the degree of
Bachelor of Technology in

COMPUTER SCIENCE AND ENGINEERING

By

Name	Roll No	PRN
Amruta Bharat Lote	4001	1962691242017
Shruti Nitin Shinde	4007	1962691242023
Mayuri Ranjit Mane	4008	2062691242005
Sonal Tanaji Kadam	4020	2062691242006

Under the guidance of

Mrs. M. S. Mane



**Department of Computer Science and Engineering,
Padmabhooshan Vasanttraodada Patil Institute of Technology,
Budhgaon.
2022-2023**



Dr. Vasantodada Patil Shetkari Shikshan Mandal's
Padmabhooshan Vasantodada Patil Institute of Technology,
Budhgaon (Approved by AICTE, New Delhi, Recognized by
Government of Maharashtra & Affiliated to DBATU)
DEPARTMENT OF COMPUTER SCIENCE & ENGINEERING

CERTIFICATE

Name	Roll No	PRN
Amruta BharatLote	4001	1962691242017
Shruti Nitin Shinde	4007	1962691242023
Mayuri Ranjit Mane	4008	2062691242005
Sonal Tanaji Kadam	4020	2062691242006

Studying in B.Tech. Computer Science and Engineering have successfully completed the project entitled

"A Computer vision based elderly people monitoring and safety system"

under the guidance and supervision of Prof. **Mrs. M. S. Mane**, during the academic year 2022-2023

towards the partial fulfillment of curriculum prescribed by Dr. Babasaheb Ambedkar Technological University, Lonere for the award of degree of Bachelor of Technology in Computer Science & Engineering.

Mrs. M. S. Mane
Guide

Mr. B. S. Patil
HOD

Dr. D. V. Ghewade
Principal

External
Examiner

College Social Networking System

A Report submitted to

Dr. BABASAHEB AMBEDKAR TECHNOLOGICAL
UNIVERSITY, LONERE

in partial fulfillment for the Degree of

BACHELOR OF TECHNOLOGY

in

Computer Science & Engineering

by

NAME	PRN NO	ROLL NO
Pranoti Suresh Nikam	2062691242001	4012
Tahira Shabbir Kalmade	2062691242002	4014
Priti Pravin Arage	1962691242021	4047
Arpita Yashwant Koli	1962691242020	4049

UNDER THE GUIDANCE OF

Dr. M. S. Patil

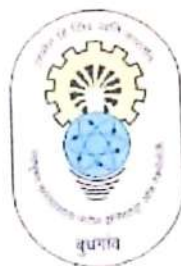

**PADMABHOOSHAN VASANTRAODADA
PATIL INSTITUTE OF TECHNOLOGY,
BUDHIGAON**

2022-2023

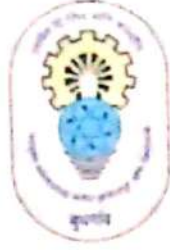

**PADMABHOOSHAN VASANTRAODADA PATIL INSTITUTE
OF TECHNOLOGY, BUDHGAON**

Department of Computer Science & Engineering

CERTIFICATE

This is to certify that the project report entitled

“College Social Networking System”

submitted by

NAME	PRN NO	ROLL NO
Pranoti Suresh Nikam	2062691242001	4012
Tahira Shabbir Kalmade	2062691242002	4014
Priti Pravin Arage	2062691242021	4047
Arpita Yashwant Koli	2062691242020	4049

to Dr. BABASAHEB AMBEDKAR TECHNOLOGICAL UNIVERSITY, LONERE, in partial fulfillment for the award of the degree of **B. Tech in Computer Science & Engineering** is a *bonafide* record of project work carried out by him/her under my/our supervision. The contents of this report, in full or in parts, have not been submitted to any other Institution or University for the award of any degree or diploma.

Date:

Mrs. M. S. Patil

Guide

Mr. B. S. Patil

Head of Department

Dr. D. V. Ghewade

Principal

Sugarcane Billet Ring Detection Using Deep Learning

A Report submitted to

**Dr. BABASAHEB AMBEDKAR TECHNOLOGICAL
UNIVERSITY, LONERE**

*In partial fulfillment for the Degree of
Bachelor of Technology
In
Computer Science and Engineering*

NAME	PRN NO	ROLLNO
Shradha Vijay Kolekar	2062691242015	4011
Vidya Vilas Gaikwad	1962691242001	4033
Sonal Sunit Deshmukh	1962691242071	4034
Isha Ajay Nimbalkar	1962691242062	4035
Yasir Ali Malla	1962691242024	4048



UNDER THE GUIDANCE OF

Ms. Rupali R. Jagtap

**PADMABHOOSHAN VASANTRAODADA PATIL
INSTITUTE OF TECHNOLOGY, BUDHGAON.
2022-2023**



**PADMABHOOSHAN VASANTRAODADA
PATIL INSTITUTE OF TECHNOLOGY,
BUDHGAON**

Department of Computer Science and Engineering

CERTIFICATE

This is to certify that the project report entitled
Sugarcane Billet Ring Detection Using Deep Learning

Submitted by,

NAME	PRN NO	ROLLNO
Shradha Vijay Kolekar	2062691242015	4011
Vidya Vilas Gaikwad	1962691242001	4033
Sonal Sunit Deshmukh	1962691242071	4034
Isha Ajay Nimbalkar	1962691242062	4035
Yasir Ali Malla	1962691242024	4048

Dr. BABASAHEB AMBEDKAR TECHNOLOGICAL UNIVERSITY, LONERE, in partial fulfillment of the award of the degree of **B. Tech in Computer Science and Engineering** is a *bonafide* record of project work carried out by him/her under my/our supervision. The contents of this report, in full or in parts, have not been submitted to any other Institution or University for the award of any degree or diploma.

Ms. Rupali R. Jagtap

Guide

Dr. B. S. Patil

Head Of Department

Dr. D. V. Ghewade

Principal

**BRAIN TUMOR DETECTION USING MRI IMAGES AND
CONSULTANT SYSTEM**

A Project Report Phase II

submitted in partial fulfilment of the requirements

for the award of the degree of

Bachelor of Technology

in

Computer Science & Engineering

by

Name	Roll no.	PRN
Namrata M. Sawant	4058	1962691242051
Pranjal A. Kandgoankar	4032	1962691242077
Prathmesh D. Patil	4064	1962691242067
Samruddhi A. Mane	4074	1962691242065
Anushka T. Rupnar	4046	1962691242035

under the guidance of
Prof. Leena V. Patil.

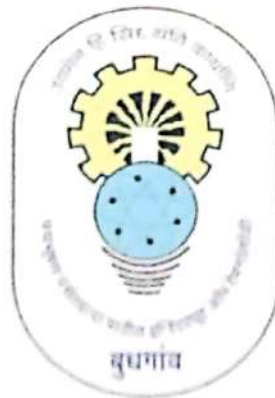

Department of Computer Science & Engineering

**Padhmabhooshan Vasanttraodada Patil Institute Of
Technology, Budhgoan.**

**DIABETES DIAGNOSTIC
PREDICTION USING MACHINE
LEARNING**

A Report submitted to

**Dr. BABASAHEB AMBEDKAR TECHNOLOGICAL
UNIVERSITY, LONERE**

In partial fulfillment for the Degree of
Bachelor of Technology
In
Computer Science and Engineering

NAME	PRN NO	ROLL NO
Snehal Rajram Patil	1962691242044	4031
Sakshi manik Misal	1962691242049	4030
Ada Abbas Shaikh	1962691242040	4021
Madhuri Pankaj Pawar	1962691242025	4029

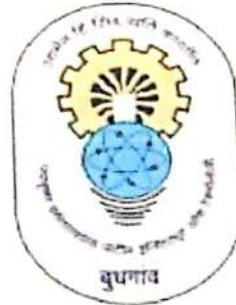

UNDER THE GUIDENCE OF

PROF. L .V PATIL

**PADMABHOOSHAN VASANTRAODADA PATIL INSTITUTE
OF TECHNOLOGY, BUDHGAON.**

2022-2023

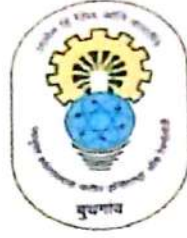

**PADMABHOOSHAN VASANTRAODADA PATIL INSTITUTE OF
TECHNOLOGY, BUDHGAON**

**Department of Computer Science and
Engineering**

CERTIFICATE

This is to certify that the project report entitled

**DIABETES DIAGNOSTIC
PREDICTION USING MACHINE
LEARNING**

Submitted by,

NAME	PRN NO	ROLL NO
Snehal Rajram Patil	1962691242044	4031
Sakshi Manik Misal	1962691242049	4030
Ada Abbas Shaikh	1962691242040	4021
Madhuri Pankaj Pawar	1962691242025	4029

To Dr. BABASAHEB AMBEDKAR TECHNOLOGICAL UNIVERSITY, LONERE,
in partial fulfillment for the award of the degree of **B. Tech in Computer Science and
Engineering** is a *bonafide* record of project work carried out by him/her under my/our
supervision. The contents of this report, in full or in parts, have not been submitted to any other
Institution or University for the award of any degree or diploma.

Prof. L.V. Patil
Guide

Dr. B. S. Patil
Head Of Department

Dr. D. V. Ghewade
Principal

CERTIFICATE

ACADEMIC YEAR 2022-23



This is to certify that the Project work entitled "**Hydrogen Generation Through Water Splitting Reaction Utilizing Waste Aluminum And Waste Water**". Is an authentic work carried out by:-

ROLL NO.	NAME	PRN No.
4011	Shinde Amar Balkrishna	1962691507039
4013	Patil Samarth Anil	1962691507025
4017	Parte Akash Gajanan	1962691507008
4055	Bagwade Siddhesh vishwanath	1962691507044

Date -.

Ash
GUIDE

Mr.A.A.Puttewar

S.L.Bhagat
HOD

Dr. S.L.BHAGAT

D.V.Gheva
PRINCIPLE

Dr. D.V.GHEVADE

Department of Chemical Engineering, PVPIT Budhgaon.

CERTIFICATE

**Padmabhooshan Vasantgadada Patil Institute of Technology,
Budhgaon**

This is to certify that project report entitled
“Extraction of fennel oil from fennel seed”

Has been successfully completed by

Student Name	PRN Number
Adhiraj Mahesh Islampure	2062691507006
Sourabh Gopal Vhankade	2062691507017
Ganesh Bhagwat Mulik	2062691507019
Aniket Ashok Hankare	2062691507020

During the prescribed report
Submitted in partial fulfillment
For
Fourth year of Degree in Chemical Engineering
Of
P.V.P.I.T Budhgaon.

Dr. S.L. Bhagat sir. (Project guide)

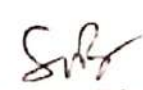
Dr. S.L. Bhagat. (H. O. D.)

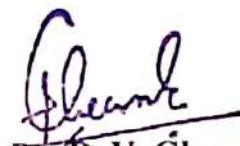
Dr. D. V. Ghevade. (Principal)

CERTIFICATE

Padmabhooshan Vasantraodada Patil Institute of Technology, Budhgaon

This is to certify that project report entitled

“Utilisation of Banana Fibre for Making Wrapping Paper”

Has been successfully completed by

ROLL NO.	NAME	PRN No.
4007	Suryawanshi Vishal Rajendra	1962691507014
4008	Patil Omkar Umesh	1962691507021
4015	Mujawar Mohasin Shakil	1962691507051

During the prescribed period the report

Submitted in partial fulfillment

For

Bachelor of Technology in Chemical Engineering

Of

Dr. Babasaheb Ambedkar Technological University Lonere, Raigad.



Dr. P.B. Dhanke.
(Project Guide)

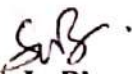

Dr. S. L. Bhagat.
(H. O. D.)

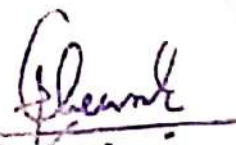

Dr. D. V. Ghewade.
(Principal)



PADMABHOOSHAN VASANTRAODADA PATIL INSTITUTE OF
TECHNOLOGY, BUDHGAON

DEPARTMENT OF CHEMICAL ENGINEERING

CERTIFICATE

This is to certify that the project report entitled

“DESIGN OF TITANIUM DIOXIDE PRODUCTION PLANT”

Has been successfully completed by

NAME OF STUDENTS	ROLL NO.	PRN NO.
Vaishnavi Mane	4004	1962691507052
Neelambika Chirumamilla	4027	1962691507057
Rohit Magdum	4025	1965691507041
Harish Channe	4035	1962691507037

To DR. BABASAHEB AMBEDKAR TECHNOLOGICAL UNIVERSITY,
LONERE in partial fulfilment for the award of the degree of **B.TECH in
Chemical Engineering** is a bonafied record of project work carried out by him/her
under mysupervision. The content of this report in fill in parts, have not been
submitted to any other institution or university for the award of any degree or
diploma.

Dr. Sanjay.B.Pawar
(Guide)

Dr. S.L. Bhagat
(H. O. D.)

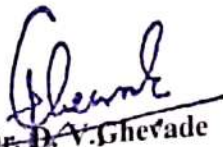
Dr. D.V. Gheade
(Principal)

Dr.V.P.S.S.M's
PADMABHOOSHAN VASANTRAODADA PATIL
INSTITUTE OF TECHNOLOGY, BUDHGAON
(SANGLI).
YEAR 2022-23

CERTIFICATE



This is certify that, this project report entitled
*“Extraction of Oil from the waste Jamun Seed
(Syzygium cumini)”*

Submitted during the academic year 2022-23

Mr. MAHADIK SHREYAS ANIL
Mr. MAHATME SUSHANT BABURAO
MR. DAMATE SATYAJIT SUDHIR
MR. JAGDALE VISHAL SHRIKANT

Students of B. tech, in partial fulfilment of the degree in Chemical Engineering of DBATU University Lonere, is found to be satisfactory and up to the standard envisaged for the level of course.

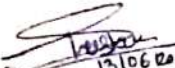
13/06/2023
Prof. S. S. Pawar
(Guide)

Dr. S. L. Bhagat
(H.O.D)

Dr. D. V. Ghewade
(Principal)

CERTIFICATE

THIS IS TO CERTIFY THAT THE PROJECT ENTILED
"STUDY OF DIFFERENT PARAMETER ON ESTERIFICATION REACTION."

SUBMITTED BY

NAME OF STUDENTS	ROLL NO.	PRN NO.
Swapnil Yadav	4048	1962691507001
Akash Phalake	4052	2062691507013
Swapnil Tangawade	4050	2062691507015
Nikhil Tangavade	4051	2062691507016

Students of final year, in partial fulfilment for the award of Degree In Chemical Engineering of DBATU University, Lonere is found to be satisfactory and up to the standard envisaged for the level of course.



Subject: Project

Date:

Place:

Guide

(Dr.S.L.Bhagat)

HOD

(Dr.S.L.Bhagat)

Principal

(Dr.D.V.Ghewade)

CERTIFICATE

Padmabhooshan Vasantnada Patil Institute of Technology, Budhgaon

This is to certify that project report entitled
“Algae-Based Carbon-dioxide Sequestration”

Has been successfully completed by

Student Name	PRN Number
Sanket Sanjay Padiyar.	2062691507010
Manoj Madhukar Patil.	2062691507018
Pramod Ananda Devkate.	2062691507023
Nitish Babaso Patil.	2062691507007

During the prescribed period the report

Submitted in partial fulfillment

For

Fourth year of Degree in Chemical Engineering

Of

P.V.P.I.T Budhgaon.

Prof. Sanjeev Pawar.
(Project guide)

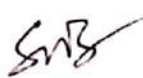
Dr. S.L. Bhagat.
(H. O. D.)

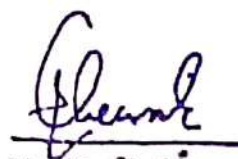
Dr. D. V. Ghevade.
(Principal)

CERTIFICATE

Padmabhooshan Vasanttraodada Patil Institute of Technology, Budhgaon

This is to certify that project report entitled

“PURIFICATION OF CRUDE GLYCEROL FROM BIODIESEL
BYPRODUCT BY ATFE FOR SEPARATION OF WATER AND
ALCOHOL”

Has been successfully completed by

Name of Students	PRN Numbers
Aniket Arvind Kardile	1962691507038
Mahesh Barma Bhusnur	1962691507043
Dhiraj Suresh Jadhav	1962691507010

During the prescribed period the report

Submitted in partial fulfillment

(2022-2023)

For

Fourth year of Degree in Chemical Engineering

Of

P.V.P.I.T Budhgaon

Prof. U. S. Patil
(Project guide)

Dr. S. L. Bhagat
(H. O. D.)

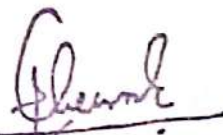
Dr. D. V. Ghevade
(Principal)

CERTIFICATE

THIS IS TO CERTIFY THAT THE PROJECT
ENTILED
"FORMULATION AND PROCESS PLANT DESIGN
FOR NATURAL HERBAL SHAMPOO BAR"

SUBMITTED BY

NAME OF STUDENTS	ROLL NO.	PRN NO.
Prathmesh Patil	4026	1962691507011
Sohel Mujawar	4041	1962691507056
Bhagesh Kole	4042	1962691507054
Rohit Desai	4046	1962691507007

Students of final year in partial fulfillment for the award of Degree In Chemical Engineering of DBATU university, Lonere is found to beat is factory and upto the standard envisaged for the level of course



Date: 13/06/2023

Place: Budhgaon

Guide

(Dr.Sanjay.B.Pawar)

HOD

(Prof.Sanjay Bhagat)

Principal

(Dr.D.V.Ghewade)



**PADMABHOOSHAN VASANTRAODADA PATIL INSTITUTE OF
TECHNOLOGY, BUDHGAON**

DEPARTMENT OF CHEMICAL ENGINEERING

CERTIFICATE

This is to certify that the project report entitled

**“ZERO FLARING SIMULATION FOR OIL AND GAS
INDUSTRY”**

Has been successfully completed by

Name of Students	PRN Numbers
Juned Abduljabbar Dadel	1962691507012
Mudassar Ahmad Md. Saleem Momin	1962691507022
Omkar Ashok Borade	1962691507050

To DR. BABASAHEB AMBEDKAR TECHNOLOGICAL UNIVERSITY, LONERE in partial fulfilment for the award of the degree of **B.TECH in Chemical Engineering** is a bonafied record of project work carried out by him/her under my supervision . The content of this report in fill in parts, have not been submitted to any other institution or university for the award of any degree or diploma

Prof. S.S Pawar
(Guide)

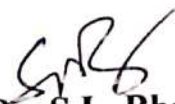
Dr. S.L. Bhagat
(H. O. D.)

Dr. D. V.GHEVDE
(Principal)

CERTIFICATE

THIS IS TO CERTIFY THAT THE PROJECT ENTILED
"FORMULATION AND EVALUATION OF
HERBAL SOAP"

SUBMITTED BY

NAME OF STUDENT	ROLL NO.	PRN NO.
Akshay Balaji Patil	4044	2062691507023
Prathamesh Sanjay Buchade	4039	2062691507005
Vinayak Gajanan Swami	4043	2062691507024
Sharad Subhash Jagadale	4045	2062691507022

Student of final year, in partial fulfilment for the award of Degree In
Chemical Engineering of DBATU University, Lonere is found to be
satisfactory and up to the standard envisaged for the level of course.

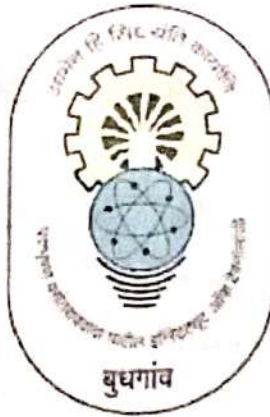

Date:

Place:

13/6/23
Guide

(Prof. U.S. Patil)

HOD

(Dr. Sanjay Bhagat)

Principal

(Dr. D.V. Ghewade)

CERTIFICATE

ACADEMIC YEAR 2022-23



This is to certify that the Project Phase- II work entitled "Experimental Evaluation Of Cavitation Coupled With Ultraviolet Rays For Treatment Of Textile Waste Water." Is an authentic work carried out by:-

ROLL NO.	NAME	PRN No.
4012	Shinde Sanket Sanjay	1962691507042
4010	Rakte Amit Dilip	1962691507040
4009	Chavan Rahul Shrikant	1962691507006

Sub - PROJECT PHASE- II

Date -.

GUIDE

Prof.V.S.KORE

HOD

Dr. S.L.BHAGAT

PRINCIPAL

DR. D.V.GHEVADE

Department of Chemical Engineering

PADMABHOOSHAN VASANTRAODADA PATIL INSTITUTE OF
TECHNOLOGY, BUDHGAON.

CERTIFICATE

Academic Year 2022-23

Padmabhooshan Vasantraodada Patil Institute of Technology, Budhgaon

This is to certify that the project entitled

"PRODUCTION OF BIO-ETHANOL FROM RICE STRAW"

Has been successfully completed by

ROLL NO.	NAME	PRN NO.
4006	Baban Dnyandev Yerudakar	2062691507009
4037	Pravin Janardhan Patil	1962691507032
40	Samarjeet Sukumar Patil	181150710007

During the prescribed period the report

Submitted In partial fulfillment

For

Fourth year of Degree in Chemical Engineering

Of

P.V.P.I.T Budhgaon



Dr. P.B.Dhanke

(Project Guide)



Dr. S.L.Bhagat

(H.O.D.)

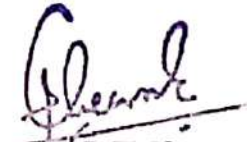

Dr. D.V.Ghewade

(Principal)

DBATU University, Lonere - Raigad.

Dr. V. P. Shetakari Shikshan Mandal's

Padmabhooshan Vasantrodada Patil Institute of Technology, Budhgaon –
416 304.

CERTIFICATE

This is to be certified that **SANTOSH CHANDRAKANT UCHHAI** students of Year B.Tech, VIII semester of Civil Engineering Department, of Dr. V. P. Shetakari Shikshan Mandal's Padmabhooshan Vasantrodada Patil Institute of Technology, Budhgaon have completed her Final Project For partial fulfillment of Degree B.Tech in Civil Engineering

**"Bituminous Paving Block - A Solution to Plastic and Demolished
Concrete Waste Management"**

She has submitted their Project Report for the partial fulfillment of the curriculum of the Degree of Bachelor of Civil Engineering from DBATU University, Loner - Raigad



Prof. R. S. PATIL
Project Guide



Dr. V. T. GAIKWAD
Head of the Department
(Civil Engineering)

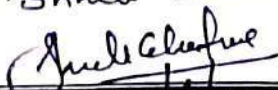

Dr. D. V. GHEWADE
Principal

Mrs. Shruuti Ahotane

14/6/23

Dr.V.P.S.S.M.'s

PADMBHOOSHAN VASANTRAODADA PATIL
INSTITUTE OF TECHNOLOGY , BUDHGAON (SANGLI)

CERTIFICATE



This is certify that the group has completed project for final year having title "Estimating and Costing of Building Project by Microsoft Excel" during academic year 2022-23.

Name

PRN No.

Mr. Bhaskar Laxmikant Khambe

1962691191013

Mr. Prajwal Krantikumar Ugale

1962691191008

Mr. Saurav Lahu Dhale

1962691191131

Mr. Pravin Krushnadev Babar

1962691191017

Mr.Kshitij Jitendra Kamble

1962691191134

Mr.R.S.Patil
(Guide)

Prof. V.T.Gaikwad
(H.O.D.)

Dr.D.V.Ghewade
(Principal)

Mrs. Shndi Ahotane

**PADMABHOOSHAN VASANTRAODADA PATIL INSTITUTE
OF TECHNOLOGY, BUDHAGAON, SANGLI.**

DEPARTMENT OF CIVIL ENGINEERING



CERTIFICATE

This is to certify that the B. Tech Project Report entitled "WATER QUALITY ANALYSIS OF WTP AND DESIGN OF WASTEWATER TREATMENT SYSTEM FOR KARNAL VILLAGE"

Submitted by :

Name	Roll no.	PRN
KATKE KASHMIRA RAVINDRA	4139	1962691191128
VIRKAR OMKAR MOHAN	4141	1962691191100
BHIUNGADE SARANG SACHIN	4149	1962691191002
PATIL VALLABH VISHNU	4154	1962691191109

to the Department of Civil Engineering of Padmabhooshan Vasanttraodada Patil Institute Of Technology, Budhagaon, Sangli in partial fulfilment for the award of Degree of **B.Tech (Civil Engineering)**. This project report is a record of the project work carried out by them under my supervision during the academic year 2022-2023.

Date : 19/6/2023

Place : Sangli

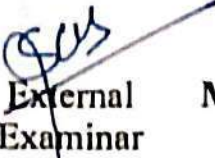
External Examiner

Mr. P. T. Patil
Guide

Prof. V. T. Gaikwad
Head of Department

Dr. D.V. Ghevade
Principal





CERTIFICATE

This is to certify that the project report entitled
"REUSE OF CERAMIC TILES AS COARSE AGGREGATES IN CONCRETE"
submitted by

Mr. JADHAV SUNIL DHONDIRAM	4150	1962691191136
Mr. MANE SHREEHARSH SURESH	4151	1962691191137
Mr. SHIKALGAR SANCHIT RAM	4152	1962691191103
Mr. NAIK RIYAZ RAJJAK	4167	1962691191102
Mr. KATYAPPA SOURABH SUKUMAR	4164	1962691191032

to Dr. BABASAHEB AMBEDKAR TECHNOLOGICAL UNIVERSITY,
LONERE, in partial fulfillment for the award of the degree of B. Tech in
CIVIL ENGINEERING is a bonafide record of project work carried out by
him/her under my/our supervision. The contents of this report, in full or in
parts, have not been submitted to any other Institution or University for the
award of any degree or diploma.

Mrs. Y. M. Pudale
(Guide)

Dr. V. T. Gaikwad
(Head Of Department)

Dr. D. V. Ghewde
(Principal)



CERTIFICATE

This is to certify that the project report entitled
“Experimental Study on Self-Healing Concrete”

submitted by

Ms. MUSKAN HARUN MANER	1962691191010
Ms. POONAM UTTAM GAVADE	1962691191020
Ms. YOGITA BALASAHEB SARGAR	1962691191011
Ms. NANDINI NITIN PAWAR	1962691191063
Ms. PRANALI PRAMOD KULKARNI	1962691191093

to Dr. BABASAHEB AMBEDKAR TECHNOLOGICAL UNIVERSITY, LONERE, in partial fulfillment for the award of the degree of B. Tech in CIVIL ENGINEERING is a bonafide record of project work carried out by him/her under my/our supervision. The contents of this report, in full or in parts, have not been submitted to any other Institution or University for the award of any degree or diploma.

Mrs. Y. M. Pudale
(Guide)

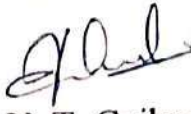
Dr. V. T. Gaikwad
(Head Of Department)

Dr. D. V. Ghewde
(Principal)

Department of Civil Engineering,

PADMABHOOSHAN VASANTRAODADA PATIL
INSTITUTE OF TECHNOLOGY, BUDHGAON.

Year: 2022-2023

CERTIFICATE

This is to certify a Project Report On

***“Experimental Study of Biaxial Hollow Slab Using GFRP Bars And
Spherical Balls”***

Is Successfully Completed as per curriculum by

NAME	PRN
Miss. Sayali Pandurang Gaikwad	1962691191054
Miss. Vaibhavi Nitin Mohite	1962691191057
Mr. Ankit Dinkar Shirke	1962691191053
Mr. Pratik Netaji Mane	1962691191105
Mr. Prathmesh Balaso Patil	1962691191092

Under the guidance of

Mrs.S.M.PATIL

Patil
15-6-23
Project Guide

Mrs.S.M.Patil.

V.T. Gaikwad
Head of Department

Dr. V.T.Gaikwad

D.V. Ghewade
Principal
Dr. D.V. Ghewade

Department of Civil Engineering,

PADMABHOOSHAN VASANTRAODADA PATIL INSTITUTE OF
TECHNOLOGY, BUDHGAON

Year: 2022-2023

CERTIFICATE

This is to certify a Project Report On

“Experimental Study Of Water Absorbing Road by Sand Drain Method

Is Successfully Completed as per curriculum by

NAME	PRN NO.
Mr. Shivtej Tanaji Shinde	1962691191007
Mr. Dipak Govind Khandekar	1962691191024
Mr. Prathamesh Subhash Olekar	1962691191090
Mr. Dhiraj Rajendra Patil	1962691191088
Mr. Rohit Ramesh Nalawade	1962691191122

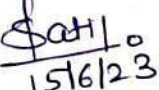
15/6/23.
Project Guide

Mrs.S.M.Patil.

Head of Department

Dr. V.T.Gaikwad

Principal

Dr. D.V. Ghewade

**PADMABHOOSHAN VASANTRAODADA PATIL
INSTITUTE OF TECHNOLOGY, BUDHGAON
Department of Civil Engineering**



CERTIFICATE

This is to certify that the project report entitled
**“ASSET MAPPING FOR DECENTRALIZED PLANNING USING
Q-GIS SOFTWARE”**

submitted by

Name of the Member	PRN Number
Sahil Narayan Nevarekar	2062691191016
Indrajit Sunil Nalawade	2062691191034
Nihalahmad Riyaj Faras	2062691191052
Anil Ramesh Jadhav	2062691191061
Pruthviraj Subhash Jadhav	2062691191053

To **Dr. BABASAHEB AMBEDKAR TECHNOLOGICAL UNIVERSITY, LONERE** in partial fulfillment for the award of the degree of **B. Tech in Civil Engineering** is a *bona fide* record of project work carried out by him under my/our supervision. The contents of this report, in full or in parts, have not been submitted to any other Institution or University for the award of any degree or diploma.

Prof. Dr. V.T. Gaikwad
Guide

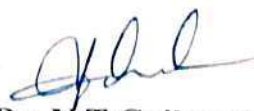
Prof. Dr. V.T. Gaikwad
Head of Department

Dr. D.V. Ghevade
Principal

DBATU University, Lonere - Raigad.

Dr. V. P. Shetakari Shikshan Mandal's

**Padmabhooshan Vasantrodada Patil Institute of Technology, Budhgaon –
416 304.**

CERTIFICATE

This is to be certified that

Mr. Sourabh Ashok Pandhare

Ms. Sumedha Suresh Chavan

Ms. Prajakta Chandrakant Khade

Mr. Anant Parshwanath Hore

Mr. Swapnil Vikas Ghatge

Mr. Ranjit Babasaheb Jadhav

students of Year B.Tech, VIII semester of Civil Engineering Department, of Dr. V. P. Shetakari Shikshan Mandal's Padmabhooshan Vasantrodada Patil Institute of Technology, Budhgaon have completed her Final Project For partial fulfillment of Degree B.Tech in Civil Engineering

“SUSTAINABLE FALSE CEILING BOARDS”

She has submitted their Project Report for the partial fulfillment of the curriculum of the Degree of Bachelor of Civil Engineering from **DBATU University, Lonere - Raigad**

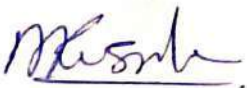

Mr. A. A. KUSANALE.

Project Guide



Dr. V. T. GAIKWAD

**Head of the Department
(Civil Engineering)**



Dr. D. V. GHEWADE

Principal

Certificate

This is to certify that, The project report entitled Use of sugar mill waste for manufacturing of bricks

Submitted by,

Name	PRN No.	Roll No.
i. Mahadik Dhairyashil Krushna	2062691191065	4250
ii. Waychal Rohit Chandrakant	2062691191025	4269
iii. Rajput Omkar Anandsingh	2062691191070	4267
iv. Prabhulkar Shreyas Vitthal	2062691191027	4271
v. Joshi Rahul Rajaram	2062691191006	4218

To Dr. BABASAHEB AMBEDKAR TECHNOLOGICAL UNIVERSITY, LONERE, in partial fulfilment for the award of the degree of **B. Tech in CIVIL ENGINEERING** is a bona fide record of project work carried out by him/her under my/our supervision . The content of this report , in full or in parts , have not been submitted to any other Institution or University for the award of any degree or diploma



Prof.S.S.Mane

Guide



Prof.V.T.Gaikwad

Head Of department

Dr.D.B.Ghevade

Principal



PADMABOOSHAN VASANTRAODAD PATIL INSTITUTE OF
TECHNOLOGY, BUDHGAON (SANGLI)

Department of Civil Engineering

CERTIFICATE

This is to certify that the project report entitled

LOW COST HOUSING Is successfully completed as per the curriculum

by

SR.NO	NAME	ROLL NO.
1.	SHREEYASH SHASHIKANT CHAVAN	4161
2.	DATTATRAYA ASHOK CHAVAN	4160
3.	ROHIT BHANUDAS DUDHAL	4159
4.	INDRAJEET YASHWANT DUDHAL	4158
5.	KIRAN ASHOK KADAM	4168

To Dr. BABASAHEB AMBERDKAR UNIVERSITY, LONERE, in partial Fulfillment of the award of Degree of **B.Tech in Civil Engineering** is Bonafide Record of project work carried out by him/her under my /our supervision. The contents of this report, in full or in parts, have not been submitted to any other Institution or University for the award of any degree or diploma.

MR.S.S.MANE

(GUIDE)

Dr.V.T.GAIKWAD

(HOD)

Dr.D.V.GHEWADE

(PRINCIPLE)



Padmabhooshan Vasanttraodada Patil Institute Of Technology, Budhgaon

(Sangli-416304)

Department of Civil Engineering

CERTIFICATE

This is to certify that

Mr. Siddiki Abubakar Landage .	2062691191030
Mr. Abhijit Mahadev Jagtap .	2062691191031
Mr. Suraj Shahaji Mahadik.	2062691191062
Mr. Vaibhav Vijaykumar Masutage.	2062691191068
Mr. Arfat Jahangir Kalangade.	2062691191084

Class - B. Tech (Civil Engineering) Div - B

Has satisfactorily carried out and completed the Project work titled

“UTILIZATION OF WASTE PLASTIC IN MANUFACTURING OF PLASTIC BRICK ALONG WITH FLY ASH”

For the partial fulfillment of the requirement
of Bachelor of Technology in Civil
Engineering.

Dr. Babasaheb Ambedkar Technological
University, Lonere.

During academic year
2022-2023

Prof. S. S. Mane

(Project Guide)

Dr. V. T. Gaikwad

(H.O.D)

Dr. D. V. Ghewade

(Principal)

Dr. Vasantodada Patil Shetakari Shikshan Mandal's
Padmabhooshan Vasantodada Patil Institute of
Technology, Budhgaon, 416304



CERTIFICATE

This is to certify that, the dissertation work entitled "Photocatalytic concrete road" which is being submitted by Ms. Ujwala T. Jadhav, Ms. Shejal A. Autade, MS. Indrayani S. Patil, Ms. Akanksha H. Patil for the partial fulfillment of requirement for award of the Bachelors of Civil Engineering degree as laid down by DBATU Lonere, Raigad as a record of his work carried out under my supervision and guidance during the year 2022-2023.

Place: P.V.P.I.T Budhgaon, Sangli

Date: 15-6-2023

Prof. S. B. Mohite
(Guide)

Dr. N. P. Phadtare
Dr. V. T. Galkwad
(HOD)

Dr. D. V. Ghewade
(Principle)

PADMABHOOSHAN VASANTRAODADA PATIL INSTITUTE OF
TECHNOLOGY, BUDHGAON

Department of Civil Engineering



CERTIFICATE

This is to certify that the project report entitled

"SMART RAILWAY DRAINAGE SYSTEM"

submitted by

Name of the Member	PRN Number
Sakshi Sunil Kokane	2062691191008
Aboli Ashok Sarde	2062691191013
Saniya Bipinchandra Sawant	2062691191047
Shivani Tanaji Mane	2062691191069
Siddharth Mahadev More	2062691191078

To Dr. BABASAHEB AMBEDKAR TECHNOLOGICAL UNIVERSITY,
LONERE in partial fulfillment for the award of the degree of B. Tech in Civil
Engineering is a bona fide record of project work carried out by him under my/our
supervision. The contents of this report, in full or in parts, have not been submitted
to any other Institution or University for the award of any degree or diploma.

ca

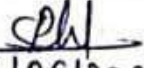
16/06/2023
Prof.S.V.PATIL

(Guide)

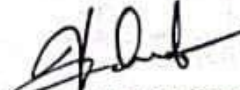
Prof. Dr. V.T.Galkwad
(Head of Department)

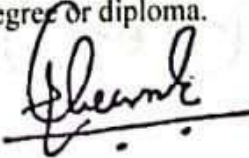
Dr. D. V. Ghevade
(Principal)

**PADMABHOOSHAN VASANTRAODADA
PATILINSTITUTE OF TECHNOLOGY,
BUDHGAON**

Department of Civil Engineering

CERTIFICATE

This is to certify that the project report entitled

REPAIR OF OLD BUILDING BY RETROFITTING APPLICATIONS

submitted by

Name of Students:	PRN NO.	ROLLNO.
1.Akash Maruti Karande	1962691191023	4142
2.Lokesh Gautam Khade	1962691191018	4153
3.Satyam Dattatray Mhamane	1962691191019	4143
4.Surajsingh Sundarsingh Tomar	1962691191120	4123
5.Aditya Chamanlal Bangotra	1962691191009	4171

to **Dr. BABASAHEB AMBEDKAR TECHNOLOGICAL UNIVERSITY, LONERE**, in partial fulfillment for the award of the degree of B. Tech in CIVIL ENGINEERING is a bona fide record of project work carried out by him/her under my/our supervision. The contents of this report, in full or in parts, have not been submitted to any other Institution or University for the award of any degree or diploma.

Prof. N.S. Patil

(Guide)

Dr. V. T. Gaikwad

(Head of department)

Dr. D. V. Ghavade

(Principal)

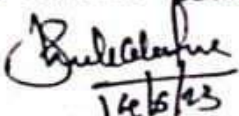
Mrs. Shachi Ghokane

14/6/23



**PADMBHOOSHAN VASNTRAODADA PATIL INSTITUTE OF
TECHNOLOGY , BUDHGAON**

Department of CIVIL ENGINEERING

Certificate

This is to certify that, The project report entitled **Eco-friendly Paving Blocks
By Using Plastic Waste .**

Submitted by,

SR. No.	NAME	ROLL NO	PRN No.
1	Ankita Papat Kamble	4201	2062691191056
2	Sourabh Somdatt Kamble	4202	2062691191039
3	Akanksha Rahul Kamble	4204	2062691191064
4	Akash Kisan Jadhav	4206	2062691191083
5	Ashutosh Chandrakant Sutar	4221	2062691191035

To Dr. BABASAHEB AMBEDKAR TECHNOLOGICAL UNIVERSITY,
LONERE, in partial fulfilment for the award of the degree of **B. Tech in CIVIL
ENGINEERING** is a bona fide record of project work carried out by him/her
under my/our supervision . The content of this report , in full or in parts , have
not been submitted to any other Institution or University for the award of any
degree or diploma

Prof. A.S. Ingale

Guide



Prof. V.T. Gaikwad

Head Of department



Dr. D.B. Ghevade

Principal

CERTIFICATE

This is to certify that the project work titled "Traffic analysis and monitoring system at intersections with design guidelines for Islampur city" is the Bonafide work submitted by the following students, to the P.V.P.I.T Budhgaon during the academic year 2022 - 23, in partial fulfillment for the award of the degree of B. Tech in Civil Engineering under our supervision. The contents of this report, in full or in parts, have not been submitted to any other Institution or University for the award of any degree.

ROLL NO	STUDENT NAME	PRN NO
4244	ABHISHEK RAJENDRA PATIL	2062691191023
4247	SANGRAM SURESH KADAM	2062691191048
4265	AMAN ZAKIRHUSEN TAMBOLI	2062691191014
4276	PRANAV RAJU PATIL	2062691191045
4277	ANUJ SUDHIR JADHAV-PATIL	2062691191077

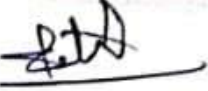
Prof. S. M. Patil sir
Project Guide

Dr. V. T. Gaikwad
HOD

Dr. D. V. Ghewade
Principal

External Examiner



Padmabhooshan Vasanttraodada Patil Institute Of Technology, Budhgaon
(Sangli-416304)

Department of Civil Engineering

CERTIFICATE

This is to certify that

SR.NO	NAME OF STUDENT	PRN NO.
2.	Mr. NIKHIL S. GEJAGE.	2062691191058
2.	Mr. SANDEEP R.YADAV.	2062691191073
3.	Mr. SACHIN DHARMAPALAN.	2062691191079

Class - B. Tech (Civil Engineering)

Has satisfactorily carried out and completed the Project work titled

“WASTE WATER TREATMENT BY PHYTHOREMEDIATION METHOD”

For the partial fulfillment of the requirement
of Bachelor of Engineering in Civil.

**Dr. Babasaheb Ambedkar Technological
University, Lonere.**

**During academic year
2022-2023**

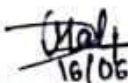
16/06/23
Prof. G. D. Mali.
(Project Guide)

Dr. V. T. Gaikwad
(H.O.D)

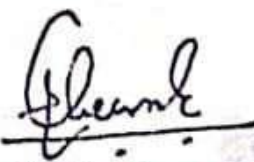
Dr. D. V. Ghewade
(Principal)

PADMABHOOSHAN VASANTRAODADA PATIL
INSTITUTE OF TECHNOLOGY, BUDHGAON

Department of Civil Engineering



CERTIFICATE

This is to certify that the project report entitled
'Intelligent Transportation System and Study of Smart Bridge'
submitted by

Name of the Member	PRN Number
Shweta Mohan Shinge	2062691191021
Shraddha Ravindra Manjare	2062691191022
Rutuja Rama Jadhav	2062691191081

To Dr. BABASAHEB AMBEDKAR TECHNOLOGICAL
UNIVERSITY, LONERE, in partial fulfillment for the award of
the degree of B. Tech in Civil Engineering is a *bona fide* record
of project work carried out by him/her under my/our supervision.
The contents of this report, in full or in parts, have not been
submitted to any other Institution or University for the award of
any degree or diploma.

Dr. V. T. Gaikwad
Guide

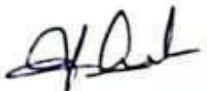
Dr. V. T. Gaikwad
Head of Department

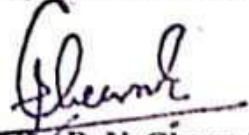
Dr. D. V. Ghewade
Principal



Padmabhooshan Vasanttraodada Patil Institute of Technology,
Budhgaon.

Department of civil Engineering

CERTIFICATE

This is to certify that the project report entitled

**DESIGN AND FABRICATION OF MORTAR LAYING
EQUIPMENT**

Submitted by,

Name of Student

PRN NO.

Khade Pratiksha Chandrakant

2062691191011

Momin Aman Hamid

2062691191028

Kore Karan Bhimrao

2062691191009

Mujawar Swaleha Suraj

2062691191066

Amrutsagar Rutuja Arun

2062691191076

Deshmane Shweta Sanjay

2062691191074

To Dr. BABASAHEB AMBEDKAR TECHNOLOGICAL UNIVERSITY, LONERE, in partial fulfilment for the award of the degree of B. Tech in civil engineering is a bonafide record of project work carried out by them under my supervision. The contents of this report, in full or in parts, have not been submitted to any other Institution or University for the award of any degree or diploma.

Mr. S.M. Patil

(GUIDE)

Dr. V. T. Gaikwad

(HOD)

Dr. D.V. Ghewade

(PRINCIPAL)



Certifies that

Ankita Jagannath Barge

Of Sangli Centre

has successfully passed

Programming in C & C++

in the month of Jan. 22.

In testimony whereof is set the seal of the said Institute.



Mumbai

Dt. : 19-02-2022

S N G 9 1 7 7

Authorised Signatory

Asst. Dir.
Director



Certifies that

Ankit Vinod Jadhav

Of Sangli *Centre*

has successfully passed

C Programming

in the month of Jan. 22

In testimony whereof  *the seal of the said Institute.*



Authorised Signatory

Mumbai

Dt. : 19-02-2022

S N G 9 1 7 8

Director

Certificate No. BWSIN/2023/03/08YAG

BWS
www.businesswebsolutions.in



THIS IS TO CERTIFY THAT

Certificate
OF INTERNSHIP IN
FULL STACK WEB DEVELOPMENT

GAYATRI VINOD PATIL

HAS COMPLETED THE INTERNSHIP OF 2 MONTHS FROM 09 JAN 2023 TO 09 MAR 2023

The candidate has gone through several modules during the internship and successfully completed all given tasks and projects based upon HTML, CSS, JAVASCRIPT, JQUERY, Bootstrap, React JS, Python, Django etc. His/her performance has been marked more than satisfactory during the entire internship period.

Lisa Hoffman

SECRETARY

LISA HOFFMAN

D Goenka

DIRECTOR

DESHRAJ GOENKA



09-Mar-2023

To verify kindly Mail at: hr@businesswebsolutions.in

APT TECH
CAMPUS RECRUITMENT TRAINING



Certificate

THIS IS TO CERTIFY THAT

MR/MS/ Sakshi Babasaheb Jadhav has successfully
Completed Certificate Course in Data Structure And Object Oriented
Programming of 1 month duration and achieved A Grade, which
was held in October 2022 - November 2022.

Mr. Rehan Chougale
(Trainer)



Mr. Sanir Kittur
(Founder of Apt-Tech)

Shri Academy, E ward plot no. 14 Mahadik Wasahat,
Near Ruikar Colony, Kolhapur



SANGLI SOFTWARE

CERTIFICATE OF ACHIEVEMENT



THE CERTIFICATE IS AWARDED FOR THE TRAINING OF
WEB DESIGNING AND WEB APPLICATION

THIS IS CERTIFY THAT MR. / MS. Shivani Subhash Jadhav
HAS SUCCESSFULLY COMPLETED THE FOUR
WEEK (15th June 2022 To 10th July 2022) INDUSTRIAL
TRAINING IN WEB DEVELOPMENT

11/07/2022

DATE



SIGNATURE

ADITYA INFOTECH

Software Development Made Easy

Ref. No.: Jan/2023/1

Date: 1/02/2023

TO WHOM IT MAY CONCERN

This is to certify that **Ms. Vaishnavi Sambhaji Wadkar** has completed training on 'Web App Development' using PHP, MySQL and Bootstrap, as a part of internship from **1 Jan 2023** to **31 Jan 2023**. During this period she was trained to work on following tools and technology.

1. HTML , CSS and JAVASCRIPT
2. BOOTSTRAP
3. PHP
4. MySQL

Her performance, behavior and attitude during this period were good.



Mr. Sachin Khot
[Technical Head]
Aditya Infotech



Certificate of Training

Pratik Deepak Deshmane

from Padmabhushan Vasantdada Patil Institute of Technology, Budhgaon has successfully completed an 8-week online training on **Programming with C and C++**. The training consisted of Getting Started With Programming in C, Diving Into C Programming, Fundamentals of Object Oriented Programming Using CPP, Diving into CPP Programming, and Building Cricket Game Application modules.
In the final assessment, Chirag Jagdish scored 67% marks.
We wish Chirag Jagdish all the best for future endeavours.



Sarvesh Agarwal
FOUNDER & CEO, INTERNSHALA

Date of certification: 2022-02-21

Certificate no.: EBE488D7-7BD2-A045-31BA-CBA4F778BD1E

For certificate authentication, please visit https://trainings.internshala.com/verify_certificate

Certificate

+91-9975819692
contact@shraddhainservice.com
www.shraddhainservice.com



Services :- Software Development, Website Design and Hosting, E-commerce, Social Media & Marketing, SMS Getaway etc.

Certificate No: 303d06a0-4adf-11ec-89a5-45a85c7c64d8

Issue Date: November 2021

Internship Completion Certificate

We are glad to inform & certify that Mr/Ms. Pranali Chougule
from PYPIT, Budhgaon (Sangli) has satisfactorily completed his/her internship in "IDE'S
Based Python program logic buildation" at Shradha IT Services of Duration One Month

During his/her internship he/she was exposed and demonstrated various logical activities in programming with a self motivated attitude.

We found him extremely inquisitive and hardworking. He/She was very much interested to learn additional logical Skills of our division and also willing to put his/her best efforts and get in to the depth of the subject to understand it better.

His / Her association with us was very fruitful and we wish him all the best for his/her future endeavors.

Virtual Internship Program

In testimony where of are set the seal and signature of the
Managing Director & CEO, SIS.

Authorized Signatory
Managing Director & CEO, SIS
Shradha IT Services Vita



SIS-CVIP

Shradha it Services-Certification in
Virtual Internship Program

“
Virtual Internship
Program
”

| Learner Code: SIS-VIP-2021 | Center Reg No: MH29E0011979 | Batch: Nov- 2021 | State: MH |

*"This Certificate of appreciation of the "SIS-CVIP Certificate". It is being awarded with conditional terms
AP-Vita Karad Road Vivekanand Nagar, Near Datt Temple Tal-Khanapur, Dist-Sangli, Maharashtra Pin-415311*



APT TECH

CAMPUS RECRUITMENT TRAINING

Certificate

THIS IS TO CERTIFY THAT

MR/MS/ Snehal Shivappa Vhankhande has successfully
Completed Certificate Course in Data Structure And Object Oriented
Programming of 1 month duration and achieved A Grade, which
was held in October 2022 - November 2022.

Mr. Rehan Chougale
(Trainer)



Mr. Sanir Kittur
(Founder of Apt-Tech)

Shri Academy, E ward plot no. 14 Mahadik Wasahat,
Near Ruikar Colony, Kolhapur



APT TECH

CAMPUS RECRUITMENT TRAINING

Certificate

THIS IS TO CERTIFY THAT

MR/MS/ Snehal Shivappa Vhankhande has successfully
Completed Certificate Course in Data Structure And Object Oriented
Programming of 1 month duration and achieved A Grade, which
was held in October 2022 - November 2022.

Mr. Rehan Chougale
(Trainer)



Mr. Sanir Kittur
(Founder of Apt-Tech)

Shri Academy, E ward plot no. 14 Mahadik Wasahat,
Near Ruikar Colony, Kolhapur



INTERNSHIP LETTER

Date: 22nd Nov 2021

TO WHOM IT MAY CONERN

This is to certify that **Mr. Chetan Kadam** has done his internship as **Digital Marketing Intern** from **14th October 2021 to 13th November 2021.**

During the internship he demonstrated good design skills with a self-motivated attitude to learn new things. His performance exceeded expectations and was able to complete the assigned task successfully on time.

We wish him all the best for his future endeavors.

Regards,



Vrushali Shinde

Director

EXCELSIOR RESEARCH PVT LTD

C Wing – 316 C/D Third Floor, Shopper's Orbit Mall, Near Big Bazar, Vishrantwadi, Pune 411015. MH, India.
CIN: U74999PN2016PTC164688 | Tel: 02067108500 Email: - hr@excelsiorresearch.com

ADITYA INFOTECH

Software Development Made Easy

Ref. No.: Jan/2023/4

Date: 1/02/2023

TO WHOM IT MAY CONCERN

This is to certify that **Ms. Asmita Damodar Waghmare** has completed training on '**Web App Development**' using PHP, MySQL and Bootstrap, as a part of internship from **1 Jan 2023** to **31 Jan 2023**. During this period she was trained to work on following tools and technology.

1. HTML , CSS and JAVASCRIPT
2. BOOTSTRAP
3. PHP
4. MySQL

Her performance, behavior and attitude during this period were good.

Mr. Sachin Khot
[Technical Head]
Aditya Infotech





Certifies that

Akshay Dilip Kadam

Of Sangli Centre

has successfully passed

Programming in C & C++

in the month of Jan. 22.

In testimony whereof is set the seal of the said Institute.



Mumbai

Dt. : 19-02-2022

S N G 9 1 9 0

Authorised Signatory

Director



APT TECH
CAMPUS RECRUITMENT TRAINING

Certificate

THIS IS TO CERTIFY THAT

MR/MS/ Priyanka Shivaji Kadam has successfully

Completed Certificate Course in Data Structure And Object Oriented

Programming of 1 month duration and achieved A Grade, which

was held in October 2022 - November 2022.

Mr. Rehan Chougale
(Trainer)



Sanir Kittur Sir's
APTTECH
Campus Recruitment Training

Mr. Sanir Kittur
(Founder of Apt-Tech)

Shri Academy, E ward plot no. 14 Mahadik Wasahat,
Near Ruikar Colony, Kolhapur



APT TECH
CAMPUS RECRUITMENT TRAINING

Certificate

THIS IS TO CERTIFY THAT

MR/MS/ Salunkhe Akanksha Mohan has successfully
Completed Certificate Course in Data Structure And Object Oriented
Programming of 1 month duration and achieved A Grade, which
was held in October 2022 - November 2022.

Mr. Rehan Chougale
(Trainer)



Sanir Kittur Sir's
APTTECH
Campus Recruitment Training

Mr. Sanir Kittur
(Founder of Apt-Tech)

Shri Academy, E ward plot no. 14 Mahadik Wasahat,
Near Ruikar Colony, Kolhapur



APT TECH
CAMPUS RECRUITMENT TRAINING

Certificate

THIS IS TO CERTIFY THAT

MR/MS/ Sheetal Uttam Mane has successfully

Completed Certificate Course in Data Structure And Object Oriented
Programming of 1 month duration and achieved A Grade, which
was held in October 2022 - November 2022.

Mr. Rehan Chougale
(Trainer)



Sanir Kittur Sir's
APTTECH
Campus Recruitment Training

Mr. Sanir Kittur
(Founder of Apt-Tech)

Shri Academy, E ward plot no. 14 Mahadik Wasahat,
Near Ruikar Colony, Kolhapur



Certifies that

Ankit Vinod Jadhav

Of Sangli *Centre*

has successfully passed

C Programming

in the month of Jan. 22

In testimony whereof to give the seal of the said Institute.



Mumbai

Dt. : 19-02-2022

S N G 9 1 7 8

Authorised Signatory

Director

Certificate of Training

Vaishnavi Kadam

has successfully completed an 8-week online training on **Ethical Hacking**. In the training, Vaishnavi learned Basics of Information Security, Computer Networking and Web Development, Information Gathering and VAPT of some important vulnerabilities in the OWASP top 10, Automating VAPT, and Documenting and Reporting Vulnerabilities.

We wish Vaishnavi all the best for future endeavours.

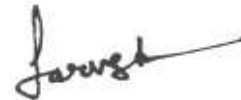

Sarvesh Agarwal

FOUNDER & CEO, INTERNSHALA

Date of certification: 2022-11-06

Certificate no. : FE1583F1-8C66-7D78-A245-A5D200D6FFA6

For certificate authentication, please visit https://trainings.internshala.com/verify_certificate



THIS IS TO CERTIFY THAT

GAYATRI VINOD PATIL

HAS COMPLETED THE INTERNSHIP OF 2 MONTHS FROM 09 JAN 2023 TO 09 MAR 2023

The candidate has gone through several modules during the internship and successfully completed all given tasks and projects based upon HTML, CSS, JAVASCRIPT, JQUERY, Bootstrap, React JS, Python, Django etc.

His/her performance has been marked more than satisfactory during the entire internship period.

Lisa Hoffman

SECRETARY

LISA HOFFMAN

D Goenka

DIRECTOR

DESHRAJ GOENKA



09-Mar-2023

Certificate
OF INTERNSHIP IN
FULL STACK WEB DEVELOPMENT



APT TECH

CAMPUS RECRUITMENT TRAINING

Certificate

THIS IS TO CERTIFY THAT

MR/MS/ Sakshi Babasaheb Jadhav has successfully

Completed Certificate Course in Data Structure And Object Oriented
Programming of 1 month duration and achieved A Grade, which
was held in October 2022 - November 2022.

Mr. Rehan Chougale
(Trainer)



Sanir Kittur Sir's
APTTECH
Campus Recruitment Training

Mr. Sanir Kittur
(Founder of Apt-Tech)

Shri Academy, E ward plot no. 14 Mahadik Wasahat,
Near Ruikar Colony, Kolhapur



SANGLI SOFTWARE

CERTIFICATE OF ACHIEVEMENT



THE CERTIFICATE IS AWARDED FOR THE TRAINING OF
WEB DESIGNING AND WEB APPLICATION



THIS IS CERTIFY THAT MR. / MS. Shivani Subhash Jadhav
HAS SUCCESSFULLY COMPLETED THE FOUR
WEEK (15th June 2022 To 10th July 2022) INDUSTRIAL
TRAINING IN WEB DEVELOPMENT

11/07/2022

DATE



SIGNATURE

Certificate of Training

Gayatri Patil

from Padmabhooshan Vasanttraodada Patil Institute of Technology, Budhgaon, Sangli has successfully completed an 8-week online training on **Ethical Hacking**. In the training, Gayatri learned Basics of Information Security, Computer Networking and Web Development, Information Gathering and VAPT of some important vulnerabilities in the OWASP top 10, Automating VAPT, and Documenting and Reporting Vulnerabilities.

We wish Gayatri all the best for future endeavours.



Sarvesh Agarwal

FOUNDER & CEO, INTERNSHALA

Date of certification: 2022-06-12

Certificate no. : 30B6A5E0-E807-0937-F9F4-A98C90CC453

For certificate authentication, please visit https://trainings.internshala.com/verify_certificate

ADITYA INFOTECH

Software Development Made Easy

Ref. No.: Jan/2023/5

Date: 1/02/2023

TO WHOM IT MAY CONCERN

This is to certify that **Ms. Bhakti Umesh Jajal** has completed training on 'Web App Development' using PHP, MySQL and Bootstrap, as a part of internship from **1 Jan 2023** to **31 Jan 2023**. During this period she was trained to work on following tools and technology.

1. HTML , CSS and JAVASCRIPT
2. BOOTSTRAP
3. PHP
4. MySQL

Her performance, behavior and attitude during this period were good.

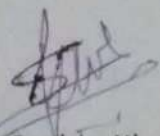
Mr. Sachin Khot

[Technical Head]

Aditya Infotech



ADITYA INFOTECH

Software Development Made Easy

Ref. No.: Jan/2023/1

Date: 1/02/2023

TO WHOM IT MAY CONCERN

This is to certify that **Ms. Vaishnavi Sambhaji Wadkar** has completed training on 'Web App Development' using PHP, MySQL and Bootstrap, as a part of internship from **1 Jan 2023** to **31 Jan 2023**. During this period she was trained to work on following tools and technology.

1. HTML , CSS and JAVASCRIPT
2. BOOTSTRAP
3. PHP
4. MySQL

Her performance, behavior and attitude during this period were good.



Mr. Sachin Khot
[Technical Head]
Aditya Infotech



31st January 2023

TO WHOM IT MAY CONCERN

This letter is to certify that **Miss. Pratiksha Pradeep Jadhav** has successfully completed her internship with **iGAP Technologies Private Limited**. Her internship tenure was from 2nd January 2023 to 31st January 2023. She was learning and working in **Python-Machine Learning**.

During the span, we found her punctual and hardworking person. Her learning powers are good and she picks up swiftly. Her feedback and evaluation proved that she learned keenly.



Mr. Abhijit P. Gatade

Director & CEO



Certificate of Training

Pratik Deepak Deshmane

from Padmabhushan Vasantdada Patil Institute of Technology, Budhgaon has successfully completed an 8-week online training on **Programming with C and C++**. The training consisted of Getting Started With Programming in C, Diving Into C Programming, Fundamentals of Object Oriented Programming Using CPP, Diving into CPP Programming, and Building Cricket Game Application modules.
In the final assessment, Chirag Jagdish scored 67% marks.
We wish Chirag Jagdish all the best for future endeavours.



Sarvesh Agarwal

FOUNDER & CEO, INTERNSHALA

Date of certification: 2022-02-21

Certificate no. : EBE488D7-7BD2-A045-31BA-CBA4F778BD1E

For certificate authentication, please visit https://trainings.internshala.com/verify_certificate

Certificate of Training

Sandhya Mohite

from **Padmabhooshan Vasantrodada Patil Institute of Technology, Budhgaon** has successfully completed a six weeks online training on **Programming with Python** from 3rd November, 2022 to 15th December, 2022. The training consisted of Introduction to Python, Using Variables in Python, Basics of Programming in Python, Principles of Object-oriented Programming (OOP), Connecting to SQLite Database, Developing a GUI with PyQT and Application of Python in Various Disciplines modules. We wish Sandhya all the best for the future.



Sarvesh Agrawal
Founder & CEO, Internshala

Date of certification: 2022-12-15

Certificate no. : F76E6DC3-766F-3A7E-B3AC-63E8BA597A46

For certificate authentication, please visit https://trainings.internshala.com/verify_certificate



Certificate of Training

Gayatri Patil

from **Padmabhooshan Vasandraodada Patil Institute of Technology, Budhgaon.** has successfully completed a six weeks online training on **Programming with Python** from 3rd November, 2022 to 15th December, 2022. The training consisted of Introduction to Python, Using Variables in Python, Basics of Programming in Python, Principles of Object-oriented Programming (OOP), Connecting to SQLite Database, Developing a GUI with PyQt and Application of Python in Various Disciplines modules. We wish Gayatri all the best for the future.

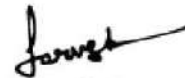
A handwritten signature in black ink, appearing to read "Sarvesh".

Sarvesh Agrawal
Founder & CEO, Internshala

Date of certification: 2022-12-15

Certificate no. : F76E6DC3-766F-3A7E-B3AC-63E8BA597A58

For certificate authentication, please visit https://trainings.internshala.com/verify_certificate

Certificate of Training

Pratiksha Dhane

from **Padmabhooshan Vasantrodada Patil Institute of Technology, Budhgaon.** has successfully completed a six weeks online training on **Programming with Python** from 3rd November, 2022 to 15th December, 2022. The training consisted of Introduction to Python, Using Variables in Python, Basics of Programming in Python, Principles of Object-oriented Programming (OOP), Connecting to SQLite Database, Developing a GUI with PyQt and Application of Python in Various Disciplines modules. We wish Pratiksha all the best for the future.



Sarvesh Agrawal
Founder & CEO, Internshala

Date of certification: 2022-12-15

Certificate no. : F76E6DC3-766F-3A7E-B3AC-63E8BA597B27

For certificate authentication, please visit https://trainings.internshala.com/verify_certificate



Certificate of Training

Pratiksha Dhane

from **Padmabhooshan Vasandraodada Patil Institute of Technology, Budhgaon.** has successfully completed a six weeks online training on **Programming with Python** from 3rd November, 2022 to 15th December, 2022. The training consisted of Introduction to Python, Using Variables in Python, Basics of Programming in Python, Principles of Object-oriented Programming (OOP), Connecting to SQLite Database, Developing a GUI with PyQt and Application of Python in Various Disciplines modules. We wish Pratiksha all the best for the future.



Sarvesh Agrawal
Founder & CEO, Internshala

Date of certification: 2022-12-15

Certificate no. : F76E6DC3-766F-3A7E-B3AC-63E8BA597B27

For certificate authentication, please visit https://trainings.internshala.com/verify_certificate



Certificate

+91-9975819692
contact@shraddhaitsservice.com
www.shraddhaitsservice.com



Services :- Software Development, Website Design and Hosting, E-commerce, Social Media & Marketing, SMS Getaway etc.

Certificate No: 303d06a0-4adf-11ec-89a5-45a85c7c64d8

Issue Date: November 2021

Internship Completion Certificate

We are glad to inform & certify that Mr/Ms. Pranali Chougule
from PYPIT, Budhgaon (Sangli) has satisfactorily completed his/her internship in "IDE'S
Based Python program logic buildation" at Shradha IT Services of Duration One Month

During his/her internship he/she was exposed and demonstrated various logical activities in
programing with a self motivated attitude.

We found him extremely inquisitive and hardworking. He/She was very much interested to learn
additional logical Skills of our division and also willing to put his/her best efforts and get in to the
depth of the subject to understand it better.

His / Her association with us was very fruitful and we wish him all the best for his/her future
endeavors.

Virtual Internship Program

In testimony where of are set the seal and signature of the
Managing Director & CEO, SIS.

Authorized Signatory
Managing Director & CEO, SIS
Shradha IT Services Vita



SIS-CVIP

Shradha it Services-Certification in
Virtual Internship Program

“
Virtual Internship
Program
”

| Learner Code: SIS-VIP-2021 | Center Reg No: MH29E0011979 | Batch: Nov- 2021 | State: MH |

*This Certificate of appreciation of the "SIS-CVIP Certificate". It is being awarded with conditional terms

AP-Vita Karad Road Vivekanand Nagar, Near Datt Temple Tal-Khanapur, Dist-Sangli, Maharashtra Pin-415311



APT TECH
CAMPUS RECRUITMENT TRAINING

Certificate

THIS IS TO CERTIFY THAT

MR/MS/ Snehal Shivappa Vhankhande has successfully
Completed Certificate Course in Data Structure And Object Oriented
Programming of 1 month duration and achieved A Grade, which
was held in October 2022 - November 2022.

Mr. Rehan Chougale
(Trainer)



Sanir Kittur Sir's
APTTECH
Campus Recruitment Training

Mr. Sanir Kittur
(Founder of Apt-Tech)

Shri Academy, E ward plot no. 14 Mahadik Wasahat,
Near Ruikar Colony, Kolhapur



APT TECH
CAMPUS RECRUITMENT TRAINING

Certificate

THIS IS TO CERTIFY THAT

MR/MS/ Snehal Shivappa Vhankhande has successfully
Completed Certificate Course in Data Structure And Object Oriented
Programming of 1 month duration and achieved A Grade, which
was held in October 2022 - November 2022.

Mr. Rehan Chougale
(Trainer)



Sanir Kittur Sir's
APTTECH
Campus Recruitment Training

Mr. Sanir Kittur
(Founder of Apt-Tech)

Shri Academy, E ward plot no. 14 Mahadik Wasahat,
Near Ruikar Colony, Kolhapur

ADITYA INFOTECH

Software Development Made Easy

Ref. No.: Jan/2023/2

Date: 1/02/2023

TO WHOM IT MAY CONCERN

This is to certify that **Ms. Shivani Vijay Buva** has completed training on 'Web App Development' using PHP, MySQL and Bootstrap, as a part of internship from **1 Jan 2023** to **31 Jan 2023**. During this period she was trained to work on following tools and technology.

1. HTML , CSS and JAVASCRIPT
2. BOOTSTRAP
3. PHP
4. MySQL

Her performance, behavior and attitude during this period were good.

Mr. Sachin Khot
[Technical Head]
Aditya Infotech



Certificate of Training

Pratiksha Dhane

from Padmbhooshan Vasandraodada Patil Institute of Technology, Budhgaon, Sangli has successfully completed an 8-week online training on **Ethical Hacking**. In the training, Pratiksha learned Basics of Information Security, Computer Networking and Web Development, Information Gathering and VAPT of some important vulnerabilities in the OWASP top 10, Automating VAPT, and Documenting and Reporting Vulnerabilities.

We wish Pratiksha all the best for future endeavours.

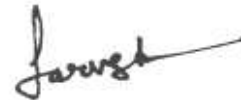

Sarvesh Agarwal

FOUNDER & CEO, INTERNSHALA

Date of certification: 2022-11-12

Certificate no. : 30B6A5E0-E807-0937-F9F4-A98C90CC4538

For certificate authentication, please visit https://trainings.internshala.com/verify_certificate

CERTIFICATE

This is to Certify that



Mr./Mrs. *Nawab R. Shaikh*.....

student of S.Y. (*C.S.E. (A.I.D.S.)*).....) from

Padmabhooshan Vasantrodada Patil Institute of Technology,

Budhgaon, Sangli

has successfully completed course training on

ADVANCE PYTHON with MACHINE LEARNING

Of 21 days duration and achieved.....*A*.....GRADE

Jan 2023 - Feb 2023



D. Bhanu
Director
Visshwa
Solutions

CERTIFICATE

This is to Certify that



Mr./Mrs. Ankush L. Bhairangal
student of S.Y. (CSE (AI&DS)) from

Padmabhooshan Vasantrodada Patil Institute of Technology,
Budhgaon, Sangli

has successfully completed course training on

ADVANCE PYTHON with MACHINE LEARNING

Of 21 days duration and achieved.....A.....GRADE

Jan 2023 - Feb 2023



Hanshm
Director
Visshwa
Solutions

CERTIFICATE

This is to Certify that



Mr./Mrs. *Tajis S. Salpute*.....

student of S.Y. (...C.S.E.....CA:2DS.....) from

Padmabhooshan Vasantrodada Patil Institute of Technology,

Budhgaon, Sangli

has successfully completed course training on

ADVANCE PYTHON with MACHINE LEARNING

Of 21 days duration and achieved.....*A*.....GRADE

Jan 2023 - Feb 2023



Prashant
Director
Visshwa
Solutions

CERTIFICATE

This is to Certify that



Mr./Mrs. *Aarti R. Patil*.....

student of S.Y. (...*C.S.E.*...*CAI.DS*.....) from

Padmabhooshan Vasantrodada Patil Institute of Technology,

Budhgaon, Sangli

has successfully completed course training on

ADVANCE PYTHON with MACHINE LEARNING

Of 21 days duration and achieved.....*A*.....GRADE

Jan 2023 - Feb 2023



Dhanish
Director
Visshwa
Solutions

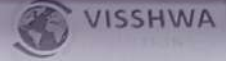

CERTIFICATE

This is to certify that

Mr./Ms./ Zehra Shebban Bhojani

student of S.Y. (CSE (AI&DS)) from Padmabhooshan Vasantrodada Patil Institute of Technology, Budhgoan, Sangli has successfully completed course training on Advance Python with Machine Learning of 21 days duration and achieved A+ Grade.

Jan 2023 - Feb 2023

Director
Visshwa Solutions



VISSHWA
SOLUTIONS

CERTIFICATE

This is to Certify that



Mr./Mrs. Ankita A. Jadhav

student of S.Y. (...CSE(AI&DS)...) from

Padmabhooshan Vasantrodada Patil Institute of Technology,

Budhgaon, Sangli

has successfully completed course training on

ADVANCE PYTHON with MACHINE LEARNING

Of 21 days duration and achieved.....A+.....GRADE

Jan 2023 - Feb 2023



Dhanish
Director
Visshwa
Solutions

CERTIFICATE

This is to Certify that



Mr./Mrs. *Pragati B. Gurav*.....

student of S.Y. (*CIE (AIIDS)*).....) from

Padmabhooshan Vasantrodada Patil Institute of Technology,

Budhgaon, Sangli

has successfully completed course training on

ADVANCE PYTHON with MACHINE LEARNING

Of 21 days duration and achieved.....*A*.....GRADE

Jan 2023 - Feb 2023



Dhanish
Director
Visshwa
Solutions

CERTIFICATE

This is to Certify that



Mr./Mrs. Shreyash A. Kadam
student of S.Y. (CSE (AI&DS)) from

Padmabhooshan Vasantrodada Patil Institute of Technology,
Budhgaon, Sangli

has successfully completed course training on

ADVANCE PYTHON with MACHINE LEARNING

Of 21 days duration and achieved.....A.....GRADE

Jan 2023 - Feb 2023



Prashant
Director
Visshwa
Solutions

CERTIFICATE

This is to Certify that



Mr./Mrs. Bhushraj A. Rote
student of S.Y. (C.E.C.A.T.D.S.) from

Padmabhooshan Vasantraodada Patil Institute of Technology,
Budhgaon, Sangli

has successfully completed course training on

ADVANCE PYTHON with MACHINE LEARNING

Of 21 days duration and achieved A GRADE

Jan 2023 - Feb 2023



Dhanish
Director
Visshwa
Solutions

CERTIFICATE

This is to Certify that



Mr./Mrs. Krushna R. Pawar

student of S.Y. (...C.E...C.A.I.n.D.S.) from

Padmabhooshan Vasantrodada Patil Institute of Technology,

Budhgaon, Sangli

has successfully completed course training on

ADVANCE PYTHON with MACHINE LEARNING

Of 21 days duration and achieved.....A.....GRADE

Jan 2023 - Feb 2023

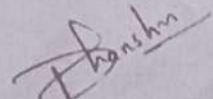

Director
Visshwa
Solutions

CERTIFICATE

This is to Certify that



Mr./Mrs. Anushri S. Kupale

student of S.Y. (...CIE...C.A.I.n.Ds...) from

Padmabhooshan Vasantrodada Patil Institute of Technology,

Budhgaon, Sangli

has successfully completed course training on

ADVANCE PYTHON with MACHINE LEARNING

Of 21 days duration and achieved A GRADE

Jan 2023 - Feb 2023



Prashant
Director
Visshwa
Solutions

CERTIFICATE

This is to Certify that



Mr./Mrs. Abhata C. Sutar

student of S.Y. (CSE (AI&DS)) from

Padmabhooshan Vasantrodada Patil Institute of Technology,

Budhgaon, Sangli

has successfully completed course training on

ADVANCE PYTHON with MACHINE LEARNING

Of 21 days duration and achieved.....A.....GRADE

Jan 2023 - Feb 2023



Dhanish
Director
Visshwa
Solutions

Duration:- 30 Jan - 20 Feb

CERTIFICATE

This is to Certify that



Mr./Mrs. *Tanishka B. Kadam*.....

student of S.Y. (...*C.S.E. (A.I.D.S.)*.....) from

Padmabhooshan Vasantrodada Patil Institute of Technology,

Budhgaon, Sangli

has successfully completed course training on

ADVANCE PYTHON with MACHINE LEARNING

Of 21 days duration and achieved.....*A*.....GRADE

Jan 2023 - Feb 2023



Dhanish
Director
Visshwa
Solutions

CERTIFICATE

This is to Certify that

Mr./Mrs. *Pranali M. Patil*

student of S.Y. (...*C.S.E.*...*(A.I.D.S.)*...) from

Padmabhooshan Vasantraodada Patil Institute of Technology,

Budhgaon, Sangli

has successfully completed course training on

ADVANCE PYTHON with MACHINE LEARNING

Of 21 days duration and achieved.....*A*.....GRADE

Jan 2023 - Feb 2023



Pranali
Director
Visshwa
Solutions



CERTIFICATE

This is to Certify that

Mr./Mrs. *Prajakta S. Suryawanshi*

student of S.Y. (...C.I.E. (A.I.T.D.S.)...) from

Padmabhooshan Vasantrodada Patil Institute of Technology,

Budhgaon, Sangli

has successfully completed course training on

ADVANCE PYTHON with MACHINE LEARNING

Of 21 days duration and achieved.....*A*.....GRADE

Jan 2023 - Feb 2023

Dhanish

Director
Visshwa
Solutions



CERTIFICATE

This is to Certify that



Mr./Mrs. Siddhi . D. Sutar.....

student of S.Y. (C.S.E. (A.T.D.S.).....) from

Padmabhooshan Vasantrodada Patil Institute of Technology,

Budhgaon, Sangli

has successfully completed course training on

ADVANCE PYTHON with MACHINE LEARNING

Of 21 days duration and achieved.....A.....**GRADE**

Jan 2023 - Feb 2023

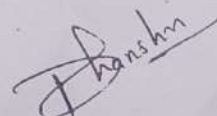

Director
Visshwa
Solutions

CERTIFICATE

This is to Certify that



Mr./Mrs. *Sanika A. Jadhav*.....

student of S.Y. (.S.S.E...C.A.T.D.S).....) from

Padmabhooshan Vasantrodada Patil Institute of Technology,

Budhgaon, Sangli

has successfully completed course training on

ADVANCE PYTHON with MACHINE LEARNING

Of 21 days duration and achieved.....*A*.....GRADE

Jan 2023 - Feb 2023



Prashant
Director
Visshwa
Solutions

CERTIFICATE

This is to Certify that



Mr./Mrs. Virushali M. Magdum
student of S.Y. (C.E. (A.I.T.S.)) from

Padmabhooshan Vasantrodada Patil Institute of Technology,
Budhgaon, Sangli

has successfully completed course training on

ADVANCE PYTHON with MACHINE LEARNING

Of 21 days duration and achieved.....A.....GRADE

Jan 2023 - Feb 2023



Dhanish
Director
Visshwa
Solutions

Name- Sujit Sanjay Jayappa
Roll No - 2042
CLASS- CSE (AI & DS)
Year - 2022 - 23

CERTIFICATE



This is to Certify that

Mr./Mrs. Sujit S. Jayappa
student of S.Y. (CSE (AI & DS)) from

Padmabhooshan Vasantraodada Patil Institute of Technology,
Budhgaon, Sangli

has successfully completed course training on

ADVANCE PYTHON with MACHINE LEARNING

Of 21 days duration and achieved.....A.....GRADE

Jan 2023 - Feb 2023



Dhanish
Director
Visshwa
Solutions

CERTIFICATE

This is to Certify that

Visshwa
Solutions

Mr./Mrs. *..Aakritya.....S.....Jadhav.....*

student of S.Y. (...C:S:F:.....CA:Z:D:R:.....) from

Padmabhooshan Vasanttraodada Patil Institute of Technology,

Budhgaon, Sangli

has successfully completed course training on

ADVANCE PYTHON with MACHINE LEARNING

Of 21 days duration and achieved.....*A*.....GRADE

Jan 2023 - Feb 2023



Prashant
Director
Visshwa
Solutions

CERTIFICATE

This is to Certify that



Mr./Mrs. *Saurabh A. Narale*.....

student of S.Y. (*CSE.CA.IDDS*).....) from

Padmabhooshan Vasantrodada Patil Institute of Technology,

Budhgaon, Sangli

has successfully completed course training on

ADVANCE PYTHON with MACHINE LEARNING

Of 21 days duration and achieved.....*A*.....GRADE

Jan 2023 - Feb 2023



Shankar
Director
Visshwa
Solutions

CERTIFICATE

This is to Certify that



Mr./Mrs. *Suati A. Kali*

student of S.Y. (...CSE... (A7.Ds)...) from

Padmabhooshan Vasantraodada Patil Institute of Technology,

Budhgaon, Sangli

has successfully completed course training on

ADVANCE PYTHON with MACHINE LEARNING

Of 21 days duration and achieved.....*A*.....GRADE

Jan 2023 - Feb 2023



Prashant
Director
Visshwa
Solutions

CERTIFICATE

This is to Certify that



Mr./Mrs.*Sanjana S. Curav*.....

student of S.Y. (...C.S.E. (A.I.D.S).....) from

Padmabhooshan Vasantrodada Patil Institute of Technology,

Budhgaon, Sangli

has successfully completed course training on

ADVANCE PYTHON with MACHINE LEARNING

Of 21 days duration and achieved.....*A*.....GRADE

Jan 2023 - Feb 2023



Dhanish
Director
Visshwa
Solutions

CERTIFICATE

This is to Certify that



Mr./Mrs. *Vaishnavi D. Alekar*.....

student of S.Y. (...C.S.E. (A.I.D.S)...) from

Padmabhooshan Vasantraodada Patil Institute of Technology,

Budhgaon, Sangli

has successfully completed course training on

ADVANCE PYTHON with MACHINE LEARNING

Of 21 days duration and achieved.....*A*.....GRADE

Jan 2023 - Feb 2023



J. Bhanushm
Director
Visshwa
Solutions

CERTIFICATE

This is to Certify that



Mr./Mrs. Niranga P. Patil
student of S.Y. (CSE (AI&DS)) from

Padmabhooshan Vasantrodada Patil Institute of Technology,
Budhgaon, Sangli

has successfully completed course training on

ADVANCE PYTHON with MACHINE LEARNING

Of 21 days duration and achieved.....A.....GRADE

Jan 2023 - Feb 2023



Prashant
Director
Visshwa
Solutions

27



CERTIFICATE

This is to Certify that

Mr./Mrs. Pratmesh S. Patil

student of S.Y. (...C.S.F. (...CAZDS;)) from

Padmabhooshan Vasantrodada Patil Institute of Technology,

Budhgaon, Sangli

has successfully completed course training on

ADVANCE PYTHON with MACHINE LEARNING

Of 21 days duration and achieved.....^A.....GRADE

Jan 2023 - Feb 2023



Pratish
Director
Visshwa
Solutions

CERTIFICATE

This is to Certify that



Visshwa
Solutions

28

Mr./Mrs. *Om R. Waghmare*

student of S.Y. (...*CE C&DS*...) from

Padmabhooshan Vasantrodada Patil Institute of Technology,

Budhgaon, Sangli

has successfully completed course training on

ADVANCE PYTHON with MACHINE LEARNING

Of 21 days duration and achieved.....*A*.....GRADE

Jan 2023 - Feb 2023



Visshwa

Prashant

Director

Visshwa
Solutions

CERTIFICATE

This is to Certify that



Mr./Mrs. *Ankita A. Patil*

student of S.Y. (*C.S.E. (A.I.D.S)*.....) from

Padmabhooshan Vasantrodada Patil Institute of Technology,

Budhgaon, Sangli

has successfully completed course training on

ADVANCE PYTHON with MACHINE LEARNING

Of 21 days duration and achieved.....*A*.....GRADE

Jan 2023 - Feb 2023



D. Bhooshan
Director
Visshwa
Solutions

CERTIFICATE

This is to Certify that



Mr./Mrs. *Ankita H. Patil*.....

student of S.Y. (*C.S.E. (AIDS)*).....) from

Padmabhooshan Vasantrodada Patil Institute of Technology,

Budhgaon, Sangli

has successfully completed course training on

ADVANCE PYTHON with MACHINE LEARNING

Of 21 days duration and achieved.....*A*.....GRADE

Jan 2023 - Feb 2023



Dhanish
Director
Visshwa
Solutions

CERTIFICATE

This is to Certify that



Mr./Mrs. *Zaif Z. Nadaf*.....

student of S.Y. (.....*CSE*.....(*A.I.D.S.*)...) from

Padmabhooshan Vasatraodada Patil Institute of Technology,

Budhgaon, Sangli

has successfully completed course training on

ADVANCE PYTHON with MACHINE LEARNING

Of 21 days duration and achieved.....*A*.....GRADE

Jan 2023 - Feb 2023



Prashant
Director
Visshwa
Solutions

CERTIFICATE

This is to Certify that



Mr./Mrs. *Sourabh S. Jure*.....

student of S.Y. (...C.S.E. (...A.Z.D.S.).....) from

Padmabhooshan Vasantrodada Patil Institute of Technology,

Budhgaon, Sangli

has successfully completed course training on

ADVANCE PYTHON with MACHINE LEARNING

Of 21 days duration and achieved.....*A*.....GRADE

Jan 2023 - Feb 2023



Prashant
Director
Visshwa
Solutions

CERTIFICATE

This is to Certify that



Mr./Mrs. *Sanika G. Sherate*

student of S.Y. (*C.S.E. (A-Z-D.S.)*) from

Padmabhooshan Vasantrodada Patil Institute of Technology,

Budhgaon, Sangli

has successfully completed course training on

ADVANCE PYTHON with MACHINE LEARNING

Of 21 days duration and achieved *A* GRADE

Jan 2023 - Feb 2023



Hanshm
Director
Visshwa
Solutions

Patil 2001-2023

34

CERTIFICATE

This is to Certify that



Mr./Mrs. *Shruti R. Patil*.....

student of S.Y. (*CSE (AI&DS)*) from

Padmabhooshan Vasantraodada Patil Institute of Technology,
Budhgaon, Sangli

has successfully completed course training on

ADVANCE PYTHON with MACHINE LEARNING

Of 21 days duration and achieved.....*A*.....**GRADE**

Jan 2023 - Feb 2023

Pranshu
Director
Visshwa
Solutions



CERTIFICATE

This is to Certify that



Mr./Mrs. *Archana S. Nikam*.....

student of S.Y. (*C.S.E. CAIDS*).....) from

Padmabhooshan Vasantodada Patil Institute of Technology,

Budhgaon, Sangli

has successfully completed course training on

ADVANCE PYTHON with MACHINE LEARNING

Of 21 days duration and achieved.....*A*.....GRADE

Jan 2023 - Feb 2023



Hanshm
Director
Visshwa
Solutions

Name - Sanmesh S. Limkar
Roll no. - 2022-23
Year
Roll no. - 2024
class - CSE (AI & DS)

CERTIFICATE



This is to Certify that

Mr./Mrs. *Sanmesh S. Limkar*

student of S.Y. (...S.E...C.A.I.D...) from

Padmabhooshan Vasantrodada Patil Institute of Technology,

Budhgaon, Sangli

has successfully completed course training on

ADVANCE PYTHON with MACHINE LEARNING

Of 21 days duration and achieved.....*A*.....GRADE

Jan 2023 - Feb 2023



Prashant
Director
Visshwa
Solutions

CERTIFICATE

This is to Certify that



Mr./Mrs. Aishwarya S. Mane
student of S.Y. (...CSE...CAI&DS...) from

Padmabhooshan Vasantrodada Patil Institute of Technology,
Budhgaon, Sangli

has successfully completed course training on

ADVANCE PYTHON with MACHINE LEARNING

Of 21 days duration and achieved.....A.....GRADE

Jan 2023 - Feb 2023



Dhanish
Director
Visshwa
Solutions

CERTIFICATE

This is to Certify that



Mr./Mrs. *Alisha B. Salunkhe*.....

student of S.Y. (.C.E. (A.I. & D.S.).....) from

Padmabhooshan Vasantrodada Patil Institute of Technology,

Budhgaon, Sangli

has successfully completed course training on

ADVANCE PYTHON with MACHINE LEARNING

Of 21 days duration and achieved.....*A*.....GRADE

Jan 2023 - Feb 2023

D. Anshu
Director
Visshwa
Solutions



CERTIFICATE

This is to Certify that



Mr./Mrs. Rohan R. Bhopale

student of S.Y. (...CSE...CAI...DS...) from

Padmabhooshan Vasantrodada Patil Institute of Technology,

Budhgaon, Sangli

has successfully completed course training on

ADVANCE PYTHON with MACHINE LEARNING

Of 21 days duration and achieved A GRADE

Jan 2023 - Feb 2023



Hanshm
Director
Visshwa
Solutions

class - SY CSE (AI&DS)

CERTIFICATE



This is to Certify that

Mr./Mrs. *Utkarsh U. Patil*

student of S.Y. (*CSE (AI&DS)*) from

Padmabhooshan Vasatraodada Patil Institute of Technology,

Budhgaon, Sangli

has successfully completed course training on

ADVANCE PYTHON with MACHINE LEARNING

Of 21 days duration and achieved.....*A*.....GRADE

Jan 2023 - Feb 2023



Prashant
Director
Visshwa
Solutions

Roll No :- 2034

21



Visshwa
Solutions

CERTIFICATE

This is to Certify that

Mr./Mrs. *Anjali V. Jadhav*

student of S.Y. (...*BCE*..... (*A.I.D.S.*).....) from

Padmabhooshan Vasantrodada Patil Institute of Technology,

Budhgaon, Sangli

has successfully completed course training on

ADVANCE PYTHON with MACHINE LEARNING

Of 21 days duration and achieved..... *A*GRADE

Jan 2023 - Feb 2023

Prashant
Director
Visshwa
Solutions



42



CERTIFICATE

This is to Certify that

Mr./Mrs. Rutuja D. Mali
student of S.Y. (CSE (A.I.Ds)) from

Padmabhooshan Vasantraodada Patil Institute of Technology,
Budhgaon, Sangli

has successfully completed course training on
ADVANCE PYTHON with MACHINE LEARNING
Of 21 days duration and achieved A GRADE

Jan 2023 - Feb 2023



Prashant
Director
Visshwa
Solutions

43



CERTIFICATE

This is to Certify that

Mr./Mrs.*Sushant M. Lakhele*.....

student of S.Y. (...*CSE (AI&DS)*.....) from

Padmabhooshan Vasatraodada Patil Institute of Technology,
Budhgaon, Sangli

has successfully completed course training on

ADVANCE PYTHON with MACHINE LEARNING

Of 21 days duration and achieved.....*A*.....GRADE

Jan 2023 - Feb 2023

[Signature]
Director
Visshwa Solutions



CERTIFICATE

Visshwa
Solutions

This is to Certify that

Mr./Mrs. *Anam B. Vijaypure*.....

student of S.Y. (.C.S.E. (AIDS).....) from

Padmabhooshan Vasantraodada Patil Institute of Technology,

Budhgaon, Sangli

has successfully completed course training on

ADVANCE PYTHON with MACHINE LEARNING

Of 21 days duration and achieved.....*A*.....GRADE

Jan 2023 - Feb 2023



Prashant
Director
Visshwa
Solutions

CERTIFICATE

This is to Certify that



Mr./Mrs. *Rushikesh M. Amare*.....

student of S.Y. (*CSE (AI&DS)*).....) from

Padmabhooshan Vasantrodada Patil Institute of Technology,

Budhgaon, Sangli

has successfully completed course training on

ADVANCE PYTHON with MACHINE LEARNING

Of 21 days duration and achieved.....*A*.....GRADE

Jan 2023 - Feb 2023

Dhanish
Director
Visshwa
Solutions



Koll no. - 2009

Class - CSE (AI&DS) 6Y



Visshwa
Solutions

CERTIFICATE

This is to Certify that

Mr./Mrs. Chirayu S. Jadhav

student of S.Y. (...CSE (AI&DS)...) from

Padmabhooshan Vasantraodada Patil Institute of Technology,

Budhgaon, Sangli

has successfully completed course training on

ADVANCE PYTHON with MACHINE LEARNING

Of 21 days duration and achieved.....A.....GRADE

Jan 2023 - Feb 2023



[Signature]

Director
Visshwa
Solutions

CERTIFICATE

This is to Certify that



Mr./Mrs. *Padmashri S. Shetti*

student of S.Y. (.C.S.E. (A.T.O.S).....) from

Padmabhooshan Vasantrodada Patil Institute of Technology,

Budhgaon, Sangli

has successfully completed course training on

ADVANCE PYTHON with MACHINE LEARNING

Of 21 days duration and achieved.....*A*.....GRADE

Jan 2023 - Feb 2023



Prashant
Director
Visshwa
Solutions

Roll No: 2031

CERTIFICATE

This is to Certify that



Mr./Mrs. *Kshitija S. Patil*

student of S.Y. (...C.S.E.C.A20.D.S.) from

Padmabhooshan Vasantrodada Patil Institute of Technology,

Budhgaon, Sangli

has successfully completed course training on

ADVANCE PYTHON with MACHINE LEARNING

Of 21 days duration and achieved.....*A*.....GRADE

Jan 2023 - Feb 2023



A. Bhooshan
Director
Visshwa
Solutions

28



CERTIFICATE

This is to Certify that

Mr./Mrs. *Ravikumar Y. Waghmode*.....

student of S.Y. (*..CSE(CA)in DS*).....) from

Padmabhooshan Vasatraodada Patil Institute of Technology,
Budhgaon, Sangli

has successfully completed course training on

ADVANCE PYTHON with MACHINE LEARNING

Of 21 days duration and achieved.....*A*.....GRADE

Jan 2023 - Feb 2023

Prashant
Director
Visshwa
Solutions



CERTIFICATE

This is to Certify that

Mr./Mrs. Akshata P. Katar

student of S.Y. (CSE (AIDS)) from

Padmabhooshan Vasantraodada Patil Institute of Technology,

Budhgaon, Sangli

has successfully completed course training on

ADVANCE PYTHON with MACHINE LEARNING

of 21 days duration and achieved A GRADE

Jan 2023 - Feb 2023

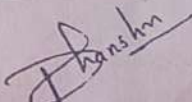

Director
Visshwa
Solutions

CERTIFICATE

This is to Certify that



Mr./Mrs. *Omkar K. Patil*.....

student of S.Y. (*CSE (AI&DS)*).....) from

Padmabhooshan Vasantrodada Patil Institute of Technology,

Budhgaon, Sangli

has successfully completed course training on

ADVANCE PYTHON with MACHINE LEARNING

Of 21 days duration and achieved.....*A*.....GRADE

Jan 2023 - Feb 2023



J. Hanshi
Director
Visshwa
Solutions

CERTIFICATE

This is to Certify that



Mr./Mrs. *Pravin T. Patil*.....

student of S.Y. (...C.E.C.I.T.D.S.).....) from

Padmabhooshan Vasantrodada Patil Institute of Technology,

Budhgaon, Sangli

has successfully completed course training on

ADVANCE PYTHON with MACHINE LEARNING

Of 21 days duration and achieved.....*A*.....GRADE

Jan 2023 - Feb 2023



Prashant
Director
Visshwa
Solutions

CERTIFICATE

This is to Certify that



Mr./Mrs.*Alhanna G. Kadam*.....

student of S.Y. (...*CSE (AI&DS)*.....) from

Padmabhooshan Vasantrodada Patil Institute of Technology,

Budhgaon, Sangli

has successfully completed course training on

ADVANCE PYTHON with MACHINE LEARNING

Of 21 days duration and achieved.....*A*.....**GRADE**

Jan 2023 - Feb 2023



Dhanish
Director
Visshwa
Solutions

CERTIFICATE



This is to Certify that

Mr./Mrs.*Aarishha R. Sawant*.....

student of S.Y. (*CSE (AI&DS)*).....) from

Padmabhooshan Vasantodada Patil Institute of Technology,

Budhgaon, Sangli

has successfully completed course training on

ADVANCE PYTHON with MACHINE LEARNING

Of 21 days duration and achieved.....*A*.....GRADE

Jan 2023 - Feb 2023



D. B. Sawant
Director
Visshwa
Solutions

CERTIFICATE

This is to Certify that

Visshwa
Solutions

Harshvardhan . S. Patil
2048
CSE(AI&DS)
2022-23

Mr./Mrs. Harshvardhan S Patil

student of S.Y. (...CSE...CA&DS...) from

Padmabhooshan Vasantrodada Patil Institute of Technology,

Budhgaon, Sangli

has successfully completed course training on

ADVANCE PYTHON with MACHINE LEARNING

Of 21 days duration and achieved...A.....GRADE

Jan 2023 - Feb 2023



Harsh
Director
Visshwa
Solutions

ACC YEAR - 22-2023
class - SY CSE (AI & DS)

CERTIFICATE



This is to Certify that

Mr./Mrs. Abhishek V. Jandave

student of S.Y. (CSE (AI & DS)) from

Padmabhooshan Vasantrodada Patil Institute of Technology,

Budhgaon, Sangli

has successfully completed course training on

ADVANCE PYTHON with MACHINE LEARNING

Of 21 days duration and achieved.....A.....GRADE

Jan 2023 - Feb 2023

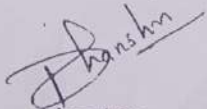

Director
Visshwa
Solutions

CERTIFICATE

This is to certify that

Mr./Ms./ Priya Naibhav Chougale

student of S.Y. (CSE (AI&DS)) from Padmabhooshan Vasantraodada Patil Institute of Technology, Budhgoan, Sangli has successfully completed course training on

Advance Python with Machine Learning
of 21 days duration and achieved A+ Grade.

Jan 2023 - Feb 2023

Director
Visshwa Solutions



VISSHWA
SOLUTIONS

CERTIFICATE

This is to Certify that



Mr./Mrs. *Navnath D. Hattikar*

student of S.Y. (*CSE (P.TDS)*) from

Padmabhooshan Vasantrodada Patil Institute of Technology,
Budhgaon, Sangli

has successfully completed course training on

ADVANCE PYTHON with MACHINE LEARNING

Of 21 days duration and achieved *A* GRADE

Jan 2023 - Feb 2023



D. Hanshm
Director
Visshwa
Solutions

CERTIFICATE

This is to Certify that



Mr./Mrs. Snehal S. Patil

student of S.Y. (.C.S.E. CO-1.D.S.) from

Padmabhooshan Vasantrodada Patil Institute of Technology,

Budhgaon, Sangli

has successfully completed course training on

ADVANCE PYTHON with MACHINE LEARNING

Of 21 days duration and achieved.....A.....GRADE

Jan 2023 - Feb 2023



Dhanish
Director
Visshwa
Solutions

CERTIFICATE

This is to Certify that



Mr./Mrs. *Giridhar A. Sonwane*.....

student of S.Y. (*C.E.(P.Zo.Ds)*).....) from

Padmabhooshan Vasantraodada Patil Institute of Technology,

Budhgaon, Sangli

has successfully completed course training on

ADVANCE PYTHON with MACHINE LEARNING

Of 21 days duration and achieved.....*A*.....GRADE

Jan 2023 - Feb 2023



D. Sonwane
Director
Visshwa
Solutions

Name - Shreyash P Managude
Roll No. = 2003
year - 2022-23
class - CSE (AI & DS)

CERTIFICATE

This is to Certify that



Mr./Mrs. Shreyash P. Managude
student of S.Y. (.....CSE.....CAI & DS.....) from

Padmabhooshan Vasantraodada Patil Institute of Technology,
Budhgaon, Sangli

has successfully completed course training on

ADVANCE PYTHON with MACHINE LEARNING

Of 21 days duration and achieved.....A.....**GRADE**

Jan 2023 - Feb 2023



Shreshth
Director
Visshwa
Solutions

CERTIFICATE

This is to Certify that



Mr./Mrs. *Kranti S. Thakole*

student of S.Y. (...CSE... (AIDS).....) from

Padmabhooshan Vasantraodada Patil Institute of Technology,

Budhgaon, Sangli

has successfully completed course training on

ADVANCE PYTHON with MACHINE LEARNING

Of 21 days duration and achieved.....*A*.....GRADE

Jan 2023 - Feb 2023



Hanshm
Director
Visshwa
Solutions

ADITYA INFOTECH

Software Development Made Easy

Ref. No.: Nov/2022/4

Date: 11/11/2022

TO WHOM IT MAY CONCERN

This is to certify that **Ms. Prerna V. Chougule** has completed training on 'Core Java Essentials' from **1 Sep 2022** to **11 Nov 2022**. During this period she was trained to work on following:

1. Java Programming Fundamentals
2. Object Oriented Programming
3. Exception Handling
4. Multithreading
5. Built-in Data Structures

Her performance, behavior and attitude during this period were good.

Mr. Sachin Khot

[Technical Head]

Aditya Infotech



ADITYA INFOTECH

Software Development Made Easy

Ref. No.: Nov/2022/5

Date: 11/11/2022

TO WHOM IT MAY CONCERN

This is to certify that **Ms. Zehra S. Bhojani** has completed training on 'Core Java Essentials' from **1 Sep 2022** to **11 Nov 2022**. During this period she was trained to work on following:

1. Java Programming Fundamentals
2. Object Oriented Programming
3. Exception Handling
4. Multithreading
5. Built-in Data Structures

Her performance, behavior and attitude during this period were good.

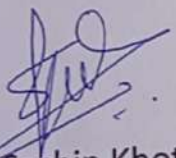
Mr. Sachin Khot

[Technical Head]

Aditya Infotech





07 sept 2022 to 07 oct 2022

Declaration of Completion

Rutuja Dilip Mali

has successfully completed the online course:
Introduction to Artificial Intelligence

This professional has demonstrated initiative and a commitment to deepening their skills and advancing their career. Well done!

07th Oct 2022

Certificate code : 3833793

Krishna Kumar
CEO



Declaration of Completion

sanika govind sherekar

has successfully completed the online course:

Introduction to Artificial Intelligence

This professional has demonstrated initiative and a commitment to deepening their skills and advancing their career. Well done!

11th Oct 2022



Krishna Kumar
CLO

CERTIFICATE NO : CERT_DZTB5LGC

CIN NO : U80900TN2012PTC083936

PANTECH SOLUTIONS
Technology Beyond the Dreams

CERTIFICATE OF INTERNSHIP



This is to certify that

SHRUTI RAJENDRA PATIL

has successfully completed

INTERNSHIP ON DEEP LEARNING (30 DAYS)

at Pantech Prolabs India Pvt Ltd

20-10-2022

DATE
OF ISSUE

M.K. JEEVARAJAN

DIRECTOR

PANTECH SOLUTIONS

www.pantechsolutions.net



Google Developers
Launchpad

CERTIFICATE

OF COMPLETION

Programming Hub Certifies that

Sushant Manvendra Lokhande

has successfully completed
Python Certification Course
and has knowledge of Python programming.

Nigel Crasto
Director
Programming Hub

Tito Idicula
Director
Programming Hub

Certificate ID: 1671362440542
Granted on December 18, 2022



Slytherin
Educating Young Minds



Certificate of Completion
This Certificate is awarded to

Sushant Lokhande

has successfully completed his/her Workshop in
**EHCCI (Ethical Hacking & Cybercrime
Investigation)** from 9th - 13th January 2023. (SID:
875308)



Slytherin EduTech
Pvt. Ltd.



Mr. Laxmi Narayan Sahu
Founder & CEO, Slytherin



tcs iON

TCS
TATA
CONSULTANCY
SERVICES
Building on belief

Certificate of Achievement

Congratulations!

Sushant Lokhande

for successfully completing

Communication Skills

a course that covers

Importance of Communication | Process of Communication | Barriers to
Communication | Non-Verbal Communication | Verbal Communication |
Effective Communication

Start Date: 18 Apr 2023

End Date: 19 Apr 2023

Mehul Mehta

Mehul Mehta
Global Delivery Head - TCS iON,
Tata Consultancy Services



CERTIFIED
Cert ID: 91305-24154158-1016
Date: 19 Apr 2023

Name - Reshma Popat Patil
Roll No - ~~69~~66
Starting date - 31 March 2023
completed on 14 April 2023
duration - 30.2 hr.

Certificate no: UC-ad4a4d9-5e00-4e24-8b5e-d3f0f8d32808
Certificate url: ude.my/UC-ad4a4d9-5e00-4e24-8b5e-d3f0f8d32808
Reference Number: 0004



CERTIFICATE OF COMPLETION

Relational Database Design

Instructors **Ben Brumm**

Reshma Popat Patil

Date **April 14, 2023**
Length **30.2 total hours**

Name :- Devyani Mahendra Ghatage ⁽⁷⁴⁾
Roll NO :- 2073 -
Starting date :- 27 March 2023
ending date :- 9 April 2023
duration 30.2 hrs.

Udemy

Certificate No: UC-215221-4155-444-107-10464827205
Certificate ID: UC-215221-4155-444-107-10464827205
Reference Number: 0004

CERTIFICATE OF COMPLETION

Relational Database Design

Instructors **Ben Brumm**

Devyani Ghatage

Date **April 9, 2023**
Length 30.2 total hours

Name - Nikita Popat Patil
Roll - 72
Starting date - 26 March 2023
Completed on 8 April 2023
Duration 30.2 hrs.



Certificate no: UC-T15t6D-94F-49v7-w6Q-wr96v092396
Certificate url: udemy/UC-T15t6D-94F-49v7-w6Q-wr96v092396
Reference Number: 0004

CERTIFICATE OF COMPLETION

Relational Database Design

Instructors **Ben Brumm**

Nikita Popat Patil

Date **April 8, 2023**
Length: 30.2 total hours

2024/03/22 16:07



Starting date - 15 Feb 2023
ending date - 2nd Mar 2023

CERTIFICATE

OF COMPLETION

**Programming Hub Certifies that
Rutuja Mallappa koli.**

has successfully completed
Python Certification Course
and has knowledge of Python programming.

CertificateID:16850239424
Feb 15th,2023- Mar
2nd,2023

Nigel Crosto
Director
Programming Hub

Titobiraj
Director
Programming Hub

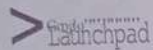

CERTIFICATE

OF COMPLETION

**Programming Hub Certifies that
Nisha Nandkumar Jadhav.**

has successfully completed
Python Certification Course
and has knowledge of Python programming.

CertificateID:16850239438
Feb 15th,2023- Mar
2nd,2023

Nigel Crosto
Director
Programming Hub

Nigel Crosto
Director
Programming Hub

Python-2023
Starting date 15 Feb 2023
Ending date 02 Mar 2023



Tecspeak
IT Solutions



Certificate

This is certify that,

Poonam gorakhnath Chandanshive

Has successfully completed the training and examination on the topic of
ASP.net & SQL

His/Her performance in the course was Excellent

udemy

Certificate URL: <https://www.udacity.com/certificate/udacity/Certificate-URL-https://www.udacity.com/certificate/udacity>
Reference Number: 0000

CERTIFICATE OF COMPLETION

Beginning C++ Programming - From Beginner to Beyond

Instructors **Tim Buchalka's Learn Programming Academy, Dr. Frank Mitropoulos**

Anjali jadhav

Date **March 22, 2022**



WDDC

WESTERN DIVISION DESIGN CENTER

AN ISO 9001:2015 CERTIFIED ORGANIZATION !!

Registered under Ministry of Micro, Small and Medium Enterprise Govt. of INDIA
UNIT OF: AAK Professional Examination Review Courses AND Architectural and Engineering Activities
& Related Technical Consultancy



CERTIFICATE OF COMPLETION

THIS CERTIFICATE IS PROUDLY PRESENTED TO

Prajakta Suryakant Suryawanshi

*Has passed the prescribed examination with A Grade (80% marks)
has been awarded the certificate in*

C Programming

COURSE DURATION 2 MONTHS

Designed and developed as per standards of

WESTERN DIVISION DESIGN CENTER

ISO 9001:2015 Certified Organization |

Registered under Ministry of Micro, Small and Medium Enterprise Govt. of INDIA

UNIT OF: AAK Professional Examination Review Courses AND Architectural and Engineering Activities & related Technical Consultancy

CERTIFICATE NUMBER

220708218985

DATE OF ISSUE :- 8th Sept 2022

A A Kumbhar

Signature

Professional Trainer

A A Kumbhar AMIE (IEI INDIA)

Sheela

EXAM EXECUTIVE

WESTERN DIVISION DESIGN CENTER

SANGLI

Grade System: A+: Excellent (89% & above) | A: Very Good (71% to 88%) | B: Good (56% to 70%) | C: Average (40% to 55%)

INTERNSHALA TRAININGS

Certificate of Training

Zehra Bhojani

from Padmabhooshan Vasanturadada Patil Institute Of Technology has successfully completed an 8-week online training on **Android App Development**. The training consisted of Introduction to Android, World of Kotlin, Android Kick-Off, Higher Order Functionalities, and The Final Project modules.

Zehra is a top performer in the training.

We wish Zehra all the best for future endeavours.

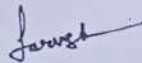

Sarvesh Agarwal
FOUNDER & CEO, INTERNSHALA

Date of certification: 2023-05-31

Certificate no. : b9d9544w7uf

For certificate authentication, please visit https://trainings.internshala.com/verify_certificate

Start date - April 2023
Roll no - 2014



Name - Archana . S . Nikam. class - T.Y. B.Tech (AI & DS) Roll No - 3028

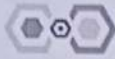

BHARAT
BLOCKCHAIN
NETWORK



HYPERLEDGER
TRAINING PARTNER

CERTIFICATE OF
COMPLETION

This certificate awarded to

Archana Nikam

This certificate is awarded on 14th June 2023
for outstanding participation and completion of
Blockchain Bootcamp Organized by IDS Inc

M Sudharshan Reddy

M SUDHARSHAN REDDY
CEO, IDS Inc.

VORUGANTI ARAVIND

ARAVIND VORUGANTI
Vice President - Blockchain
Practice & Products, Inc.

IDS_BBNUK2GST2W

3



This certificate awarded to

Omkar Kumar Pol

This certificate is awarded on 20th July 2023
for outstanding participation and completion of
Blockchain Bootcamp Organized by IDS Inc

M Sudharshan Reddy

M SUDHARSHAN REDDY
CEO, IDS Inc.

IDS_BBNY2GHM00V

VORUGANTI ARAVIND

ARAVIND VORUGANTI
Vice President - Blockchain
Practice & Products, Inc.

3

KOM-11

4



This certificate awarded to

Rushi Amane

This certificate is awarded on 20th July 2023
for outstanding participation and completion of
Blockchain Bootcamp Organized by IDS Inc

M Sudharshan Reddy

M SUDHARSHAN REDDY
CEO, IDS Inc.

IDS_BBNV2GHM00V

VORUGANTI ARAVIND

ARAVIND VORUGANTI
Vice President - Blockchain
Practice & Products, Inc.

5



This certificate awarded to

Chirayu Jadhav

This certificate is awarded on 20th July 2023
for outstanding participation and completion of
Blockchain Bootcamp Organized by IDS Inc

M Sudharshan Reddy

M SUDHARSHAN REDDY
CEO, IDS Inc.

IDS_BBNV2GHM00V

VORUGANTI ARAVIND

ARAVIND VORUGANTI
Vice President - Blockchain
Practice & Products, Inc.



BHARAT
BLOCKCHAIN
NETWORK



HYPERLEDGER
TRAINING PARTNER

CERTIFICATE OF
COMPLETION



This certificate awarded to

Rutuja Koli

This certificate is awarded on 26th May 2023
for outstanding participation and completion of
Blockchain Bootcamp Organized by IDS Inc

M Sudharshan Reddy

M SUDHARSHAN REDDY
CEO, IDS Inc.

ARAVIND VORUGANT

ARAVIND VORUGANT
Vice President - Blockchain
Practice & Products, Inc.

IDS_BBNWXEZ7PPI

2024/07/23 14:03

Roll No - 3057.

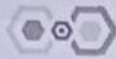

BHARAT
BLOCKCHAIN
NETWORK



HYPERLEDGER
TRAINING PARTNER

CERTIFICATE OF
COMPLETION



This certificate awarded to

Nisha Jadhav

This certificate is awarded on 28th May 2023
for outstanding participation and completion of
Blockchain Bootcamp Organized by IDS Inc

M Sudharshan Reddy

M SUDHARSHAN REDDY
CEO, IDS Inc.

VORUGANTI ARAVIND

ARAVIND VORUGANTI
Vice President - Blockchain
Practice & Products, Inc.

IDS_BBNQ2LVQTH0

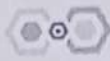

BHARAT
BLOCKCHAIN
NETWORK



HYPERLEDGER
TRAINING PARTNER



This certificate awarded to

Tejas Satpute

This certificate is awarded on 06th June 2023
for outstanding participation and completion of
Blockchain Bootcamp Organized by IDS Inc

M. Sudharshan Reddy

M SUDHARSHAN REDDY
CEO, IDS Inc.

IDS_BBNTWXITDOJ

VORUGANTI ARAVIND

ARAVIND VORUGANTI
Vice President - Blockchain
Practice & Products, Inc.

Name :- Vrushali Mahadevi Magdum roll No - 3044 .



CERTIFICATE OF
COMPLETION



This certificate awarded to

Vrushali Magdum

This certificate is awarded on 21st May 2023
for outstanding participation and completion of
Blockchain Bootcamp Organized by IDS Inc

M Sudharshan Reddy

M SUDHARSHAN REDDY
CEO, IDS Inc.

IDS_BBNPOHCIR4D

VORUGANTI ARAVIND

ARAVIND VORUGANTI
Vice President - Blockchain
Practice & Products, Inc.

2066



CERTIFICATE OF
COMPLETION

This certificate awarded to

2066_Reshma Patil

This certificate is awarded on 30th May 2023
for outstanding participation and completion of
Blockchain Bootcamp Organized by IDS Inc

M Sudharshan Reddy

M SUDHARSHAN REDDY
CEO, IDS Inc.

IDS_BBNAUWBHAIG

VORUGANTI ARAVIND

ARAVIND VORUGANTI
Vice President - Blockchain
Practice & Products, Inc.



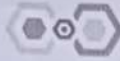

BHARAT
BLOCKCHAIN
NETWORK



HYPERLEDGER
TRAINING PARTNER

CERTIFICATE OF
COMPLETION

This certificate awarded to

2073_Devyani Ghatage

This certificate is awarded on 30th May 2023
for outstanding participation and completion of
Blockchain Bootcamp Organized by IDS Inc

M Sudharshan Reddy

M SUDHARSHAN REDDY
CEO, IDS Inc.

IDS_BBNAUWBHAIG

VORUGANTI ARAVIND

ARAVIND VORUGANTI
Vice President - Blockchain
Practice & Products, Inc.

3072



CERTIFICATE OF
COMPLETION

This certificate awarded to

2072_Nikita Patil

This certificate is awarded on 30th May 2023
for outstanding participation and completion of
Blockchain Bootcamp Organized by IDS Inc

M Sudharshan Reddy

M SUDHARSHAN REDDY
CEO, IDS Inc.

IDS_BBNAUWBHAIG

VORUGANTI ARAVIND

ARAVIND VORUGANTI
Vice President - Blockchain
Practice & Products, Inc.



CERTIFICATE OF COMPLETION

Presented to

Ankita Anandarao Jadhav

For successfully completing a free online course
Database Management System

Provided by

Great Learning Academy

(On August 2022)

AI SDS TY

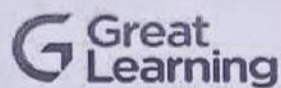

CERTIFICATE OF COMPLETION

Presented to

Anjali Vijay Jadhav

For successfully completing a free online course
OOps in Python

Provided by

Great Learning Academy

(On August 2023)

SkillUP

by Simplilearn

Declaration of Completion

Prerna Vaibhav Chougule

has successfully completed the online course:

Introduction to Artificial Intelligence

This professional has demonstrated initiative and a commitment to deepening their skills and advancing their career. Well done!

3 APRIL 2023

Certificate code : 3249771

3 March 2023 to 3 April 2023



Krishna Kumar
CEO



CERTIFICATE

OF COMPLETION

Programming Hub Certifies that

Poonam Gorakhnath Chandanshive

has successfully completed

Python Certification Course

and has knowledge of Python programming.

Certificate ID: 16850239424
Granted on:
Feb. 15th 2023- Mar 2th, 2023

Nigel Crosta
Director
Programming Hub

Nigel Crosta
Director
Programming Hub

Roll no - 3063 6 Weeks Internship

CERTIFICATE

This is to Certify that

Mr./Mrs. Anushri S. Kuptale

student of S.Y. (...CIE...C.A.I.n.Ds...) from

Padmabhooshan Vasantrodada Patil Institute of Technology,

Budhgaon, Sangli

has successfully completed course training on

ADVANCE PYTHON with MACHINE LEARNING

Of 21 days duration and achieved A GRADE

Jan 2023 - Feb 2023



Phanshi
Director
**Visshwa
Solutions**

Certificate of Training

Rutuja Dandavate

has successfully completed an 8-week online training on **Web Development**. The training consisted of HTML, CSS, Bootstrap, DBMS, PHP, JS, React, and Final Project modules.

Rutuja scored 93% marks in the final assessment and is a top performer in the training.

We wish Rutuja all the best for future endeavours.

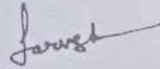

Sarvesh Agarwal

FOUNDER & CEO, INTERNSHALA

Date of certification: 2023-09-05

Certificate no.: akjy5hzzvl

For certificate authentication, please visit https://trainings.internshala.com/verify_certificate

Roll no - 3011

26th Mar - 7th April

6 Weeks Internship



DeepLearning.AI

CERTIFICATE

COURSE COMPLETION

This Certificate is Presented To :

Pradyumna Vishal Joshi

We are thrilled to extend our warmest congratulations on your successful completion of the

Web Development course

Your dedication, hard work, and passion for learning have truly paid off. It's inspiring to see how you've mastered the ins and outs of web development, from front-end design to back-end functionality. This achievement not only reflects your commitment to personal and professional growth but also positions you as a skilled and capable web developer in the ever-evolving digital landscape.

As you embark on the next chapter of your journey,

Course Duration : 7th August to 30th September 2023

ANDREW NG
Authorized Signatory

Build your AI career
with DeepLearning.AI



Certificate no: UC-2653901e-0a9d-4cc8-b3fc-32b2dfcbfda0

Certificate url: ude.my/UC-2653901e-0a9d-4cc8-b3fc-32b2dfcbfda0

Reference Number: 0004

CERTIFICATE OF COMPLETION

React JS- Complete Guide for Frontend Web Development

Instructors **EdYoda Digital University, Qaifi Khan, Mavludin Abdulkadirov**

Digvijay Subhash Bhosale

Date **Oct. 9, 2023**

Length **22 total hours**



Certificate no: UC-900469ef-ccf3-43f1-9143-12d0b5ebc5d6

Certificate url: ude.my/UC-900469ef-ccf3-43f1-9143-12d0b5ebc5d6

Reference Number: 0004

CERTIFICATE OF COMPLETION

[NEW] Ultimate AWS Certified Cloud Practitioner CLF-C02

Instructors **Stephane Maarek | AWS Certified Cloud Practitioner, Solutions Architect, Developer**

Pratik Pandurang Chavan

Date **Nov. 25, 2023**

Length **15 total hours**

Certificate of Completion

awarded to

Rutuja Sandip Upase

for successfully completing 6 weeks internship using IBM SkillsBuild in

Front End Development (FED)

From June 12,2023 to July 24,2023.

This program was conducted in collaboration with **All India Council for Technical Education (AICTE)** and **Edunet Foundation**

A handwritten signature in blue ink, appearing to read "Nagesh Singh", is written over a horizontal blue line.

Nagesh Singh
Executive Director-
Edunet Foundation

Certificate of Training

Ajay Patil

from P.V.P Institute Of Technology, Budhgaon has successfully completed a 6-week online training on **Programming with Python**. The training consisted of Introduction to Python, Using Variables in Python, Basics of Programming in Python, Principles of Object-oriented Programming (OOP), Connecting to SQLite Database, Developing a GUI with PyQt, Application of Python in Various Disciplines, and The Final Project modules.

Ajay scored 100% marks in the final assessment and is a top performer in the training.

We wish Ajay all the best for future endeavours.

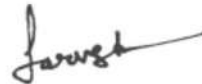

Sarvesh Agarwal

FOUNDER & CEO, INTERNSHALA

Date of certification: 2023-09-04

Certificate no. : 8zv9z2o1zkz

For certificate authentication, please visit https://trainings.internshala.com/verify_certificate



CERTIFICATE OF COMPLETION

Presented to

Anand Konnur

For successfully completing a free online course
Introduction to Artificial Intelligence

Provided by

Great Learning Academy

(On November 2023)

Certificate of Training

Usha kudale

from PVPIT Budhgaon has successfully completed an 8-week online training on **Android App Development**. The training consisted of Introduction to Android, World of Kotlin, Android Kick-Off, Higher Order Functionalities, and The Final Project modules.

Usha scored 98% marks in the final assessment and is a top performer in the training.

We wish Usha all the best for future endeavours.

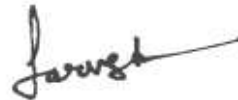

Sarvesh Agarwal

FOUNDER & CEO, INTERNSHALA

Date of certification: 2023-09-15

Certificate no. : jk7x0d3zzd0

For certificate authentication, please visit https://trainings.internshala.com/verify_certificate



Certificate no: UC-664743aa-ad16-4468-a187-6c9628c698c3

Certificate url: ude.my/UC-664743aa-ad16-4468-a187-6c9628c698c3

Reference Number: 0004

CERTIFICATE OF COMPLETION

The Complete Android N Developer Course

Instructors **Rob Percival, Marc Stock, Codestars** • **over 2 million students worldwide!**

27_Rameshwari Kolekar

Date **Nov. 24, 2023**

Length **32.5 total hours**

Certificate of Training

Sakshi Ramteke

from PVPIT Budhgaon has successfully completed an 8-week online training on **Android App Development**. The training consisted of Introduction to Android, World of Kotlin, Android Kick-Off, Higher Order Functionalities, and The Final Project modules.

Sakshi scored 98% marks in the final assessment and is a top performer in the training.

We wish Sakshi all the best for future endeavours.

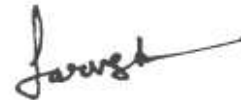

Sarvesh Agarwal

FOUNDER & CEO, INTERNSHALA

Date of certification: 2023-09-15

Certificate no. : jk7x0d3zzd0

For certificate authentication, please visit https://trainings.internshala.com/verify_certificate

Certificate of Training

Tulasi Latane

from PVPIT Budhgaon has successfully completed an 8-week online training on **Android App Development**. The training consisted of Introduction to Android, World of Kotlin, Android Kick-Off, Higher Order Functionalities, and The Final Project modules.

Tulasi scored 98% marks in the final assessment and is a top performer in the training.

We wish Tulasi all the best for future endeavours.

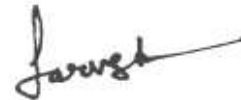

Sarvesh Agarwal

FOUNDER & CEO, INTERNSHALA

Date of certification: 2023-09-15

Certificate no. : jk7x0d3zzd0

For certificate authentication, please visit https://trainings.internshala.com/verify_certificate

Certificate of Training

Sanika Lohar

from PVPIT Budhgaon has successfully completed an 8-week online training on **Android App Development**. The training consisted of Introduction to Android, World of Kotlin, Android Kick-Off, Higher Order Functionalities, and The Final Project modules.

Sanika scored 98% marks in the final assessment and is a top performer in the training.

We wish Sanika all the best for future endeavours.



Sarvesh Agarwal

FOUNDER & CEO, INTERNSHALA

Date of certification: 2023-09-15

Certificate no. : jk7x0d3zzd0

For certificate authentication, please visit https://trainings.internshala.com/verify_certificate



Certificate no: UC-66474Jaa-ad16-4460-a1U7-6c'26'2Uc6'26cJ

Certificate id: ride.my/UC-66474Jaa-ad16-4460-a1U7-6c'26'2Uc6'20cJ

Reference NrimlJe: 0004

CERTIFICATE OF COMPLETION

The Complete Android N Developer Course

Instructors Rob Percival, Marc Stock, Codestars • over 2 million students worldwide!

Bhagyashree Urunkar

Date Nov. 24, 2023

Length 32.5 total hours



CERTIFICATE OF COMPLETION

Presented to

Tanvi Shinde

For successfully completing a free online course
C for Beginners

Provided by

Great Learning Academy

(On September 2022)

To verify this certificate visit verify.mygreatlearning.com/GVUWMPOG



Certificate no: UC-66474Jaa-ad16-4460-a1U7-6c'26'2Uc6'26cJ

Certificate id: ride.my/UC-66474Jaa-ad16-4460-a1U7-6c'26'2Uc6'20cJ

Reference NrimlJe: 0004

CERTIFICATE OF COMPLETION

The Complete Android N Developer Course

Instructors Rob Percival, Marc Stock, Codestars • over 2 million students worldwide!

Chhaya Kamble

Date Nov. 24, 2023

Length 32.5 total hours

INTERNSHIP OFFER LETTER

Date : 03/11/2023

ID:CS11WX1153S7

Dear.

Prachi Rajendra Arage

We would like to congratulate you on being selected for the " Java Programming" internship position with "CodSoft". We at CodSoft are excited that you will join our team.

The duration Of the internship will be Of 4 weeks, starting from 05 November 2023 to 05 December 2023 The internship is an educational opportunity for you hence the primary focus is on learning and developing new skills and gaining hands-on knowledge, We believe that you will perform all your tasks/projects,

As an intern. we expect you to perform all assigned tasks to the best of your ability and follow any lawful and reasonable instructions provided to you.

We are confident that this internship will be a valuable experience for you, we look forward to working with you and helping you achieve your career goals.

Best of Luck!

Thank You!





Certificate of Training

Digvijay Sherikar

from PADMBHOOSHAN VASANTRAODADA PATIL INSTITUTE OF TECHNOLOGY has successfully completed an 8-week online training on **Data Structures & Algorithms**. The training consisted of Introduction to Data Structures, Introduction to Algorithms, Single & Double Dimensional Arrays, Searching & Sorting, Stacks & Queues, Revision of relevant topics in C, Implementation programs of Stacks & Queues, Linear linked list, Circular linked list, Doubly linked list, Trees, and Graphs modules.

Digvijay scored 96% marks in the final assessment and is a top performer in the training.

We wish Digvijay all the best for future endeavours.

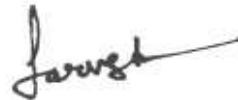

Sarvesh Agarwal

FOUNDER & CEO, INTERNSHALA

Date of certification: 2023-08-10

Certificate no. : a4t1ziktf75

For certificate authentication, please visit https://trainings.internshala.com/verify_certificate

Certificate of Training

Shubham Chopade

from Pvpit sangli has successfully completed an 8-week online training on **Web Development**. The training consisted of HTML, CSS, Bootstrap, DBMS, PHP, JS, React, and Final Project modules. Shubham scored 97% marks in the final assessment and is a top performer in the training. We wish Shubham all the best for future endeavours.

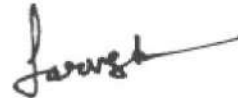

Sarvesh Agarwal
FOUNDER & CEO, INTERNSHALA

Date of certification: 2023-11-07

Certificate no. : 6cbpaow0hp9

For certificate authentication, please visit https://trainings.internshala.com/verify_certificate



InfoLogic Techvision LLP.

Head Office: "Kapila", Office No 3 & 4, MSEB Road,

Vishrambag, Sangli- 416415

Phone: (0233) 2300206, 9422973942

Web: www.i-logic.in email:support@i-logic.in

Date of issue :28 / 11 /2023

INTERNSHIP CERTIFICATE

To,

MAHAMADJAKI MAHAMADFARUK KALANGADE,

Padmabhooshan Vasantrodada Patil Institute of Technology,Sangli (Budhgaon)

This is to certify that **MAHAMADJAKI MAHAMADFARUK KALANGADE** has successfully completed at internship at "**InfoLogic Techvision LLP., Sangli** " Kapila, Office No 3 & 4, Near M.S.E.B, Vishrambag, Sangli-416415 Maharashtra India. from 2023/08/28 to 2023/10/31 (8-week).

During the internship period, mahamadjaki Actively participated in **Windows Form Application Development** project and tasks under the guidance of our Software testing department. The internee displayed a strong commitment to learning and adapting to new technologies and demonstrated excellent teamwork and communication skills.

mahamadjaki was involved in the following key activities:

- Assisting the Software Tester team in troubleshooting software issues
- Participating in the development and testing of new software applications.
- Collaborating with the team to implement security protocols and measures.
- Contributing to the maintenance and upkeep of the company's IT infrastructure.
- Engaging in regular team meetings and discussions to provide insights and suggestions.
- .NET Framework Technology was used to build Windows Form Application Project.
- This Technology was integrated with C#, Windows Forms App , .NET Framework , ASP.NET core for Desktop Apps and SQL (Microsoft SQL Server Management Studio - 2022) for backend database.

Through their dedication and enthusiasm, mahamadjaki made a valuable contribution to our IT initiatives. Their ability to grasp complex concepts quickly and their proactive approach to problem-solving were highly commendable.

We believe that the knowledge and experience gained during this internship will serve as a strong foundation for mahamadjaki as they pursue a career in the IT field.

We wish mahamadjaki all the best in their future endeavors.



InfoLogic Techvision LLP., Sangli

Certificate of Training

Ishita Kadekar

from PVPIT has successfully completed a 6-week online training on **Machine Learning**. The training consisted of Introduction to Machine Learning, Data, Introduction to Python, Data Exploration and Pre-processing, Linear Regression, Introduction to Dimensionality Reduction, Logistic Regression, Decision Tree, Ensemble Models, and Clustering (Unsupervised Learning) modules.

Ishita scored 100% marks in the final assessment and is a top performer in the training.

We wish Ishita all the best for future endeavours.



Sarvesh Agarwal

FOUNDER & CEO, INTERNSHALA

Date of certification: 2023-11-09

Certificate no. : ichshz16uvd

For certificate authentication, please visit https://trainings.internshala.com/verify_certificate

Certificate of Training

Pradnya Chalavade

from Padmabhooshan vasantraodada patil institute of technology sangli bhudagaon has successfully completed a 6-week online training on **Machine Learning**. The training consisted of Introduction to Machine Learning, Data, Introduction to Python, Data Exploration and Pre-processing, Linear Regression, Introduction to Dimensionality Reduction, Logistic Regression, Decision Tree, Ensemble Models, and Clustering (Unsupervised Learning) modules.

Pradnya is a top performer in the training.
We wish Pradnya all the best for future endeavours.

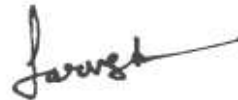

Sarvesh Agarwal

FOUNDER & CEO, INTERNSHALA

Date of certification: 2023-10-09

Certificate no. : 4qfjqln2w8_

For certificate authentication, please visit https://trainings.internshala.com/verify_certificate

CERTIFICATE

This is to Certify that



Mr./Mrs. *Shivkirti J. Shinde*

student of S.Y. (..... *CSE*) from

Padmabhooshan Vasatraodada Patil Institute of Technology,

Budhgaon, Sangli

has successfully completed course training on

ADVANCE PYTHON with MACHINE LEARNING

Of 21 days duration and achieved..... *A* GRADE

Jan 2023 - Feb 2023



J. Bhanu
Director
Visshwa
Solutions

Certificate of Training

Dhanashri Jadhav

from Padmabhooshan vasantraodada patil institute of technology sangli bhudagaon has successfully completed a 6-week online training on **Machine Learning**. The training consisted of Introduction to Machine Learning, Data, Introduction to Python, Data Exploration and Pre-processing, Linear Regression, Introduction to Dimensionality Reduction, Logistic Regression, Decision Tree, Ensemble Models, and Clustering (Unsupervised Learning) modules.

Dhanashri is a top performer in the training.
We wish Dhanashri all the best for future endeavours.

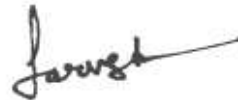

Sarvesh Agarwal

FOUNDER & CEO, INTERNSHALA

Date of certification: 2023-09-11

Certificate no. : 4qfjqln2w8_

For certificate authentication, please visit https://trainings.internshala.com/verify_certificate

Certificate of Training

Gauravi Kadam

has successfully completed a 6-week online training on **Machine Learning**. The training consisted of Introduction to Machine Learning, Data, Introduction to Python, Data Exploration and Pre-processing, Linear Regression, Introduction to Dimensionality Reduction, Logistic Regression, Decision Tree, Ensemble Models, and Clustering (Unsupervised Learning) modules.

Gauravi scored 100% marks in the final assessment and is a top performer in the training.

We wish Gauravi all the best for future endeavours.

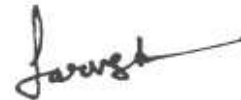

Sarvesh Agarwal

FOUNDER & CEO, INTERNSHALA

Date of certification: 2023-11-09

Certificate no. : ajc3sgasux9

For certificate authentication, please visit https://trainings.internshala.com/verify_certificate



Pantech e Learning
DIGITAL LEARNING SIMPLIFIED

CERTIFICATE NO PEL-IETE-PART-04-8178

PANTECH SOLUTIONS
Technology Beyond The Dreams

CERTIFICATE OF PARTICIPATION

NAME Ashvee Anil Gaikwad
COLLEGE Pvpit

has Successfully Completed
30 Days Masterclass on Database Management System

at Pantech e Learning Pvt Ltd, Chennai

From 25.05.2023 to 25.06.2023

Sh. K. K. Thakur
CHAIRMAN
IETE, Ranchi

M. Malaiyappan
Director
Pantech e learning

Certificate of Course Completion

Suraj Khade

has successfully achieved student level credential for completing the Network Defense course.

The student was able to proficiently:

- Use cybersecurity concepts to document a network security posture.
- Configure security measures on network devices and Linux and Windows endpoints.
- Implement phases of identity lifecycle management.
- Configure a simulated network firewall.
- Recommend cloud security measures given a scenario.
- Determine the appropriate data protection mechanism to ensure secure transport and storage of network data.
- Explain how the public key infrastructure (PKI) is used to enhance data security.
- Implement virtual computing environments.

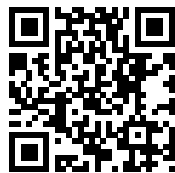

Scan to Verify

Laura Quintana

Laura Quintana
Vice President and General Manager
Cisco Networking Academy

October 30, 2023



DeepLearning.AI

CERTIFICATE

COURSE COMPLETION

This Certificate is Presented To :

Mandar Sachin Jadhav

We are thrilled to extend our warmest congratulations on your successful completion of the

Web Development course

Your dedication, hard work, and passion for learning have truly paid off. It's inspiring to see how you've mastered the ins and outs of web development, from front-end design to back-end functionality.

This achievement not only reflects your commitment to personal and professional growth but also positions you as a skilled and capable web developer in the ever-evolving digital landscape.

As you embark on the next chapter of your journey,

Course Duration : 7th August to 30th September 2023

ANDREW NG
Authorized Signatory

Build your AI career
with DeepLearning.AI



DeepLearning.AI

CERTIFICATE

COURSE COMPLETION

This Certificate is Presented To :

Prasad Pramod Kshirsagar

We are thrilled to extend our warmest congratulations on your successful completion of the

Web Development course

Your dedication, hard work, and passion for learning have truly paid off. It's inspiring to see how you've mastered the ins and outs of web development, from front-end design to back-end functionality. This achievement not only reflects your commitment to personal and professional growth but also positions you as a skilled and capable web developer in the ever-evolving digital landscape.

As you embark on the next chapter of your journey,

Course Duration : 7th August to 30th September 2023

ANDREW NG
Authorized Signatory

Build your AI career
with DeepLearning.AI



DeepLearning.AI

CERTIFICATE

COURSE COMPLETION

This Certificate is Presented To :

Sumit Suresh Mali

We are thrilled to extend our warmest congratulations on your successful completion of the

Web Development course

Your dedication, hard work, and passion for learning have truly paid off. It's inspiring to see how you've mastered the ins and outs of web development, from front-end design to back-end functionality. This achievement not only reflects your commitment to personal and professional growth but also positions you as a skilled and capable web developer in the ever-evolving digital landscape.

As you embark on the next chapter of your journey,

Course Duration : 7th August to 30th September 2023

ANDREW NG
Authorized Signatory

Build your AI career
with DeepLearning.AI

Date: 01/11/2023
Ref No: COM20231715

INTERNSHIP CERTIFICATE

We here by certify that **Mr. Pranav Papat Shinde** student of the **B.Tech** Third year from **Padmahooshan Vasantrao Dada Patil Institute of Technology , Budhagaon**. Has completed Associated level Internship with **COMTRANSE TECHNOLOGY Pvt.Ltd KOLHAPUR**, from 01/09/2023 To 30/10/2023. During the above period, he learnt technology such as **MERN STACK** development under the guidance of **Mrs. Pramila J. Vibhute & Mr. Tejas S. Patil**.

During his internship period with **COMTRANSE TECHNOLOGY** we found his diligent and enthusiastic, and his performance has been assessed as excellent.

"We wish all the best to his future endeavours."



Comtranse Technology Pvt.Ltd.
HR Executive
Trupti Gaikwad - Devane





CERTIFICATE OF INTERNSHIP

This Certificate Is Proudly Presented To

Anuja Chandrakant Kanse

For Successfully Completing An Internship On

Web Development

From **10/09/2023** To **09/10/2023** At TechnoHacks EduTech.

During This Internship, We Found Him/Her Consistent And Hardworking. We Wish All The Best For Future Endeavors.

Sandip Gavit
Founder



10/10/2023

Date





DeepLearning.AI

CERTIFICATE

COURSE COMPLETION

This Certificate is Presented To :

Jaid Riyaj Sutar

We are thrilled to extend our warmest congratulations on your successful completion of the

Web Development course

Your dedication, hard work, and passion for learning have truly paid off. It's inspiring to see how you've mastered the ins and outs of web development, from front-end design to back-end functionality.

This achievement not only reflects your commitment to personal and professional growth but also positions you as a skilled and capable web developer in the ever-evolving digital landscape.

As you embark on the next chapter of your journey,

Course Duration : 7th August to 30th September 2023

ANDREW NG
Authorized Signatory

Build your AI career
with DeepLearning.AI



DeepLearning.AI

CERTIFICATE

COURSE COMPLETION

This Certificate is Presented To :

Anuraj Bharat Lote

We are thrilled to extend our warmest congratulations on your successful completion of the

Web Development course

Your dedication, hard work, and passion for learning have truly paid off. It's inspiring to see how you've mastered the ins and outs of web development, from front-end design to back-end functionality.

This achievement not only reflects your commitment to personal and professional growth but also positions you as a skilled and capable web developer in the ever-evolving digital landscape.

As you embark on the next chapter of your journey,

Course Duration : 7th August to 30th September 2023

ANDREW NG
Authorized Signatory

Build your AI career
with DeepLearning.AI



DeepLearning.AI

CERTIFICATE

COURSE COMPLETION

This Certificate is Presented To :

Prathamesh Suresh Sawant

We are thrilled to extend our warmest congratulations on your successful completion of the

Web Development course

Your dedication, hard work, and passion for learning have truly paid off. It's inspiring to see how you've mastered the ins and outs of web development, from front-end design to back-end functionality. This achievement not only reflects your commitment to personal and professional growth but also positions you as a skilled and capable web developer in the ever-evolving digital landscape.

As you embark on the next chapter of your journey,

Course Duration : 7th August to 30th September 2023

ANDREW NG
Authorized Signatory

Build your AI career
with DeepLearning.AI



DeepLearning.AI

CERTIFICATE

COURSE COMPLETION

This Certificate is Presented To :

Ramjan Mehabusab Nadaf

We are thrilled to extend our warmest congratulations on your successful completion of the

Web Development course

Your dedication, hard work, and passion for learning have truly paid off. It's inspiring to see how you've mastered the ins and outs of web development, from front-end design to back-end functionality.

This achievement not only reflects your commitment to personal and professional growth but also positions you as a skilled and capable web developer in the ever-evolving digital landscape.

As you embark on the next chapter of your journey,

Course Duration : 7th August to 30th September 2023

ANDREW NG
Authorized Signatory

Build your AI career
with DeepLearning.AI



DeepLearning.AI

CERTIFICATE

COURSE COMPLETION

This Certificate is Presented To :

Rohan Uttam Patil

We are thrilled to extend our warmest congratulations on your successful completion of the

Web Development course

Your dedication, hard work, and passion for learning have truly paid off. It's inspiring to see how you've mastered the ins and outs of web development, from front-end design to back-end functionality. This achievement not only reflects your commitment to personal and professional growth but also positions you as a skilled and capable web developer in the ever-evolving digital landscape.

As you embark on the next chapter of your journey,

Course Duration : 7th August to 30th September 2023

ANDREW NG
Authorized Signatory

Build your AI career
with DeepLearning.AI



DeepLearning.AI

CERTIFICATE

COURSE COMPLETION

This Certificate is Presented To :

Srushti Vijaykumar Maske

We are thrilled to extend our warmest congratulations on your successful completion of the

Web Development course

Your dedication, hard work, and passion for learning have truly paid off. It's inspiring to see how you've mastered the ins and outs of web development, from front-end design to back-end functionality. This achievement not only reflects your commitment to personal and professional growth but also positions you as a skilled and capable web developer in the ever-evolving digital landscape.

As you embark on the next chapter of your journey,

Course Duration : 7th August to 30th September 2023

ANDREW NG
Authorized Signatory

Build your AI career
with DeepLearning.AI



DeepLearning.AI

CERTIFICATE

COURSE COMPLETION

This Certificate is Presented To :

Swapnil Hanamant Pawar

We are thrilled to extend our warmest congratulations on your successful completion of the

Web Development course

Your dedication, hard work, and passion for learning have truly paid off. It's inspiring to see how you've mastered the ins and outs of web development, from front-end design to back-end functionality. This achievement not only reflects your commitment to personal and professional growth but also positions you as a skilled and capable web developer in the ever-evolving digital landscape.

As you embark on the next chapter of your journey,

Course Duration : 7th August to 30th September 2023

ANDREW NG
Authorized Signatory

Build your AI career
with DeepLearning.AI



DeepLearning.AI

CERTIFICATE

COURSE COMPLETION

This Certificate is Presented To :

Viraj Rajendra Chavan

We are thrilled to extend our warmest congratulations on your successful completion of the

Web Development course

Your dedication, hard work, and passion for learning have truly paid off. It's inspiring to see how you've mastered the ins and outs of web development, from front-end design to back-end functionality. This achievement not only reflects your commitment to personal and professional growth but also positions you as a skilled and capable web developer in the ever-evolving digital landscape.

As you embark on the next chapter of your journey,

Course Duration : 7th August to 30th September 2023

ANDREW NG
Authorized Signatory

Build your AI career
with DeepLearning.AI

Date: 01/11/2023

Ref No:COM20231702

INTERNSHIP CERTIFICATE

We here by certify that **Miss.Nikita Dilip Pukale** student of the **B.Tech Third year from Padmbhooshan Vasantrao Dada Patil Institute of Technology ,Budhagaon.** Has completed Associated level internship with **COMTRANSE TECHNOLOGY Pvt.Ltd KOLHAPUR,** from 01/09/2023 To 30/10/2023.During the above period, she learnt technology such as MERN STACK development under the guidance of **Mrs.Pramila J.Vibhute & Mr.Tejas S.Patil.**

During her internship period with **COMTRANSE TECHNOLOGY** we found her diligent and enthusiastic, and her performance has been assessed as excellent.

“We wish all the best to her future endeavours.”



Comtranse Technology Pvt.Ltd.
HR Executive
Trupti Gaikwad - Devane

Date: 01/11/2023

Ref No:COM20231701

INTERNSHIP CERTIFICATE

We here by certify that **Miss.Mayuri Malhari Jadhav** student of the **B.Tech Third year from Padmbhooshan Vasantrao Dada Patil Institute of Technology ,Budhagaon.** Has completed Associated level internship with **COMTRANSE TECHNOLOGY Pvt.Ltd KOLHAPUR,** from 01/09/2023 To 30/10/2023.During the above period, she learnt technology such as MERN STACK development under the guidance of **Mrs.Pramila J.Vibhute & Mr.Tejas S.Patil.**

During her internship period with **COMTRANSE TECHNOLOGY** we found her diligent and enthusiastic, and her performance has been assessed as excellent.

“We wish all the best to her future endeavours.”



Comtranse Technology Pvt.Ltd.
HR Executive
Trupti Gaikwad - Devane

Certificate of Training

Vishal Wale

from Padmabhooshan Vasantraodada Patil Institute Of Technology Budhgaon has successfully completed a 6-week online training on **Programming with Python**. The training consisted of Introduction to Python, Using Variables in Python, Basics of Programming in Python, Principles of Object-oriented Programming (OOP), Connecting to SQLite Database, Developing a GUI with PyQT, Application of Python in Various Disciplines, and The Final Project modules.

Vishal scored 100% marks in the final assessment and is a top performer in the training.
We wish Vishal all the best for future endeavours.



Sarvesh Agarwal

FOUNDER & CEO, INTERNSHALA

Date of certification: 2023-02-16

Certificate no. : 1441pwkpxz

For certificate authentication, please visit https://trainings.internshala.com/verify_certificate



Phone : 0233-2314172, Cell: 9545453977

31 Aug 2023

Internship Certificate

To,

Vipul Vivek Kulkarni.

Padmabhooshan Vasantraodada Patil Institute of Technology.

This is to certify that Vipul Vivek Kulkarni has successfully completed an internship at "Shiv Infotech" Opposite of GST Office East of Chintamani Nagar Madhavnagar Road Sangli 416416. from 2023/08/03 to 2023/08/31.

During the internship period, Vipul Actively participated in CRM project and tasks under the guidance of our IT department. The intern displayed a strong commitment to learning and adapting to new technologies and demonstrated excellent teamwork and communication skills.

Vipul was involved in the following key activities:

- Assisting the IT team in troubleshooting software issues.
- Participating in the development and testing of new software applications.
- Collaborating with the team to implement security protocols and measures.
- Contributing to the maintenance and upkeep of the company's IT infrastructure.
- Engaging in regular team meetings and discussions to provide insights and suggestions.
- Angular Technology was used to build CRM Project.
- This Technology was integrated with TypeScript,HTML,Bootstrap,Asp.net core for Web API and SQL for backend database.

Through their dedication and enthusiasm, Vipul made a valuable contribution to our IT initiatives. Their ability to grasp complex concepts quickly and their proactive approach to problem-solving were highly commendable.

We believe that the knowledge and experience gained during this internship will serve as a strong foundation for Vipul as they pursue a career in the IT field.

We wish Vipul all the best in their future endeavors.

Salim Pinjari

Head Of Department,

Shiv Infotech

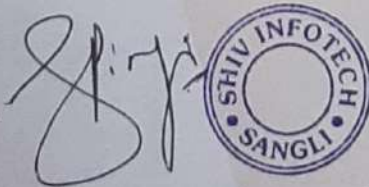

Shiv Bhavan , 2nd Floor Plot No.4887/66, RajNagar, East of Chintamani Nagar, MadhavNagar Road, Sangli.

31 Aug 2023

Internship Certificate

To,

Atharv Alok Patankar.

Padmabhooshan Vasanttraodada Patil Institute of Technology.

This is to certify that Atharv Alok Patankar has successfully completed an internship at "Shiv Infotech" Opposite of GST Office East of Chintamani Nagar Madhavnagar Road Sangli 416416. from 2023/08/03 to 2023/08/31.

During the internship period, Atharv Actively participated in CRM project and tasks under the guidance of our IT department. The intern displayed a strong commitment to learning and adapting to new technologies and demonstrated excellent teamwork and communication skills.

Atharv was involved in the following key activities:

- Assisting the IT team in troubleshooting software issues.
- Participating in the development and testing of new software applications.
- Collaborating with the team to implement security protocols and measures.
- Contributing to the maintenance and upkeep of the company's IT infrastructure.
- Engaging in regular team meetings and discussions to provide insights and suggestions.
- Angular Technology was used to build CRM Project.
- This Technology was integrated with TypeScript,HTML,Bootstrap,Asp.net core for Web API and SQL for backend database.

Through their dedication and enthusiasm, Atharv made a valuable contribution to our IT initiatives. Their ability to grasp complex concepts quickly and their proactive approach to problem-solving were highly commendable.

We believe that the knowledge and experience gained during this internship will serve as a strong foundation for Atharv as they pursue a career in the IT field.

We wish Atharv all the best in their future endeavors.

Salim Pinjari

Head Of Department,

Shiv Infotech

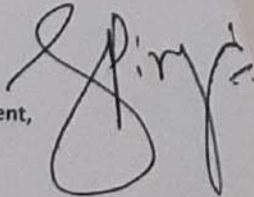

Certificate of Training

Swapnil Salunkhe

has successfully completed an 8-week online training on **Web Development**. The training consisted of HTML, CSS, Bootstrap, DBMS, PHP, JS, React, and Final Project modules.

Swapnil is a top performer in the training.

We wish Swapnil all the best for future endeavours.

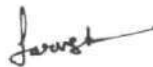

Sarvesh Agarwal

FOUNDER & CEO, INTERNSHALA

Date of certification: 2023-09-09

Certificate no. : 9AEBE69A-6297-D7EB-298D-260B81E46119

For certificate authentication, please visit https://trainings.internshala.com/verify_certificate



CERTIFICATE OF INTERNSHIP

This Certificate Is Proudly Presented To

Prachi Satish Patil

For Successfully Completing An Internship On

Web Development

From **10/09/2023** To **09/10/2023** At TechnoHacks EduTech.

During This Internship, We Found Him/Her Consistent And Hardworking. We Wish All The Best For Future Endeavors.

Sandip Gavit
Founder



10/10/2023

Date



Certificate of Training

Aishwarya Hasbe

has successfully completed a 6-week online training on **Cloud computing with AWS**. The training consisted of Introduction to Cloud Computing, Getting Started with AWS, AWS Identity & Access Management, Simple Storage Service (S3), Virtual Private Cloud (VPC), Elastic Compute Cloud (EC2), High-Level Architecture, Database, AWS Advanced Services, AWS Security & Management Services, AWS Billing and Pricing, and Training Conclusion and Final Project modules.

We wish Aishwarya all the best for future endeavours.



Sarvesh Agarwal

FOUNDER & CEO, INTERNSHALA

Course ID: 2022-08-76 Cert. ID: 6C68A9A2-8B76-5E23-B0DF-3E3905ECFCBD

For more details, visit: https://trainings.internshala.com/verify_certificate

Certificate of Training

Yogesh Kore

from PVPIT COLLAGE BUDHGAON has successfully completed an 8-week online training on **Data Structures & Algorithms**. The training consisted of Introduction to Data Structures, Introduction to Algorithms, Single & Double Dimensional Arrays, Searching & Sorting, Stacks & Queues, Revision of relevant topics in C, Implementation programs of Stacks & Queues, Linear linked list, Circular linked list, Doubly linked list, Trees, and Graphs modules.

In the final assessment, Yogesh scored 43% marks.

We wish Yogesh all the best for future endeavours.

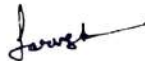

Sarvesh Agarwal

FOUNDER & CEO, INTERNSHALA

Date of certification: 2022-06-15

Certificate no.: 57473CD6-DD24-9BFF-9EC9-E2B3DA1EE81A

For certificate authentication, please visit https://trainings.internshala.com/verify_certificate



ENVITECHENGINEERINGSERVICES

0-504, Dhara Complex, Plot No. 21, Sector 8, Kamothe, Panvel, Raigadh, Maharashtra -410206

☎ 9970683645

✉ envitechngservices@gmail.com

CERTIFICATE

This is to certify that Miss. Anuja Ajit Chougule(Bhose).
She has completed 1 month of Industrial Training in production department
From 01/09/2022 to 30/10/2022 with great sincerity , punctuality and
enthusiastically.

We wish her best of luck for her future.

Thanking you



Mr. Sumit Nakate
Envitech Engineering Services
7972469504

दुरध्वनी . . : ०२३३/२३०१७४५,२३०५८६०
e-mail - sdo1252@ho.mahadiscom.in
website- www.mahadiscom.in

महावितरण
(महाराष्ट्र शासन अंगीकृत)
CIN: U40109MH2005SGC153645

उपकार्यकारी अभियंता यांचे कार्यालय
संवसु विश्रामबाग उपविभाग,व,
विश्रामबाग सांगली 416415.
ता. मिरज जि. सांगली.

जा.क्रं उपकार्य.अभि/वि.बाग/मासंवि/ No-2290

दिनांक 27-06-2022

दाखला

दाखला देणेत येतो की, श्री अजिंक्य अजितसिंह सकळे, TY BTech (पी.व्ही.पी. इन्स्टिट्यूट बुधगाव) हे उपविभाग विश्रामबाग अंतर्गत 33/11 के.व्ही. उपकेंद्र येथे (शाखा कार्यालय कवलापूर) या ठिकाणी दि. 26.05-2022 ते 23-06-2022 अखेर 28 दिवसाचे प्रशिक्षण पूर्ण केले आहे.

सदरचा दाखला हा त्यांच्या दिनांक 24-06-2022 रोजीच्या विनंती अर्जानुसार प्रशिक्षण पूर्ण केले म्हणून देणेत येत आहे.

(के.ए.टी. चव्हाण)

उपकार्यकारी अभियंता
म.रा.वि.वि.कं.मर्या.
उपविभाग विश्रामबाग

प्रती,
अजिंक्य अजितसिंह सकळे.
TY BTech



ELECTRO - INDIA

For Weigh in Weight

MANUFACTURER, SALES & SERVICES OF
ELECTRONIC WEIGHING MACHINE
An ISO 9001:2008 Certified Company

LG ELECTRO INDUSTRIES

-  CORPORATE OFFICE
PLOT NO. 20, CHANSHYAM NAGAR, MADHANAGAR ROAD,
SANGLI - 416 416, (MAHARASHTRA), PH. 0233 2314242
-  Email : electroindia14@gmail.com ■ electroindiaindustries@gmail.com
-  Mobile : 9422506828, 9422409458 ■ www.electro-india.in

Date – 7 / 10 / 2022

TRAINING CERTIFICATE

This is to certify that, **Mr. Adarsh Sandeep Jadhav of Degree B.Tech ENTc** from the College **PVPIIT Budhgaon** has completed **Industrial Training in Electro India Sangli** in the Period of **5 Sept. 2022 to 5 Oct. 2022**. According to this he completed **4 week** training.

In the training period we found him a sincere, honest, hardworking, dedicated trainee with a professional attitude and very good job knowledge. In this duration we gave him training of all types of weighing machines in two sections namely hardware section and software section . We found him work satisfactory because of his sincerity, dedication and hard work.

We have found him to be a self starter who is new invention view. We wish him all the best and success in future career.

For Electro-India

(Authorized Signatory)



अभिला प्रदाते गीर कलावा.....संगली, महाराष्ट्र

Roll no. 06

Certificate of Training

Aniket Koshti

from Padmabhooshan Vasanttraodada Patil Institute Of Technology, Budhgaon, Sangli . has successfully completed an 8-week online training on **Programming with C and C++**. The training consisted of Getting Started With Programming in C, Diving Into C Programming, Fundamentals of Object Oriented Programming Using CPP, Diving into CPP Programming, and Building Cricket Game Application modules.

We wish Aniket all the best for future endeavours.



Sarvesh Agarwal

FOUNDER & CEO, INTERNSHALA

Date of certification: 2022-11-05

Certificate no. : F26C4AE4-E93C-2428-8214-0B3D5D7DEE5E

For certificate authentication, please visit https://trainings.internshala.com/verify_certificate



Infitech Automation India Pvt. Ltd.

Technical People - Infinite Solutions

Infitech Automation India Pvt. Ltd.
H No 22/173, The Maruti Mandir, Yeshiva
Nagar, Vadgaon, Marol, Pune-412105,
Maharashtra, India.
Email: info@infitech-automation.co.in
infitech-automation.co.in
Website: www.infitech-automation.co.in

TO WHOMSOEVER IT MAY CONCERN

This is to certify that Mr. Anshuman Nilin Adale, a student of Electronics & Telecommunication Engineering, Padmahoushan Vasantradada Patil Institute of Technology, Budhgaon, has successfully completed 4 Weeks (From 01 september 2022 to 30 september 2022) Internship program at this Basics Information of Industrial Automation with PLC Development & PLC Programming. During the period of his internship program. He was found punctual hardworking and inquisitive.

We wish him every success in life.

For
INFITECH AUTOMATION INDIA PVT. LTD.

Authorized Signature

Place: Pune
Date: 30/09/2022



ENVITECHENGINEERINGSERVICES

0-504, Dhara Complex, Plot No. 71, Sector 8, Kamothhe, Puneet, Ranjath, Maharashtra-410706

99710432445

envitechenggservices@gmail.com

CERTIFICATE

This is to certify that Miss. Jyoti Balaso Chavan.

She has completed 1 month of Industrial Training in production department
From 01/09/2022 to 30/10/2022 with great sincerity , punctuality and
enthusiastically.

We wish her best of luck for her future.

Thanking you



Jyoti

Mr. Sumit Nakate
Envitech Engineering Services
7972469504

CERTIFICATE OF COMPLETION

THIS IS CERTIFY THAT

Prajakta Sanjay Zambre

Successfully completed Internship in Python
Programming. Duration: **6 Weeks** conducted by
RacksonsIT Developers Pvt Ltd, Pune and Trainer and
consultant Mr. Abhay Chougule,
Date: 1-6-22 to 15-7-22



A handwritten signature in black ink, appearing to read 'Abhay Chougule'.

ABHAY CHOUGULE
FOUNDER & CEO
8237180203



CERTIFICATE OF COMPLETION

THIS IS CERTIFY THAT

Sai Balasaheb Havale

Successfully completed Internship in Python
Programming. Duration: **6 Weeks** conducted by
RacksonsIT Developers Pvt Ltd, Pune and Trainer and
consultant Mr. Abhay Chougule.

Date: 1-6-22 to 15-7-22



A handwritten signature in black ink, appearing to read 'Abhay Chougule'.

ABHAY CHOUGULE

FOUNDER & CEO

8237180203



G.S.

CONTROLSET

35 / 1, Shanivar Peth,
Madhavnagar 416 406
Dist.: Sangli, Maharashtra
E-mail -: gscontrolset@gmail.com
mob -: 9890594051

Date 05/ 10/ 2022

Training Certificate

*This is to certify That, Ruturaj Tanaji Patil
from **B.Tech** of the College **PVPIT Budhgaon** has completed
Industrial Training at our workshop during the Period,
from **1 Sept. 2022 to 30 Sept. 2022.***

*In the training period we found him /her a sincere, honest, hardworking,
dedicated trainee with a professional attitude and very good job knowledge.*

In this duration we gave him / her training of PCB Designing & Testing.

We found his / her work satisfactory because of dedication and hard work.

Regards,
G. S. Karandikar
call 9860875917

G. S. CONTROLSET

Proprietor

SMH

MEDITATION SCHOOL INDIA
Stay, Study Practice & Teaching Meditation

CERTIFICATE

O . F . C . O . M . P . L . E . T . I . O . N .

This Certificate Is Presented To

AZMATALI SHOUKAT NADAF

This is to certify that Azmatali Shoukat Nadaf, has successfully completed his internship with Shree Mahesh Heritage during the month of May.

During the period, he handled Data Entry Position for our company.

During the course of internship, He has shown great amount of responsibility, sincerity and a genuine willingness to learn and zeal to take on new assignments & challenges. In particular, his coordination skills and communication skills are par excellence and his attention to details is impressive.

We wish him all the very best for his future.

05/06/2022

Date



Pulkit Gupta
Founder



ELECTRO - INDIA

Real Way to Weigh

MANUFACTURER, SALES & SERVICES OF
ELECTRONIC WEIGHING MACHINE
An ISO 9001:2008 Certified Company
LG ELECTRO INDUSTRIES



CORPORATE OFFICE

PLOT NO. 20, GHANSHYAM NAGAR, MADHAVNAGAR ROAD,
SANGLI - 416 416, (MAHARASHTRA) PH. 0233-2314242

Email : electroindia1@gmail.com ■ electroindianindustries@gmail.com



Mobile : 9425608828, 9422409458 ■ www.electro-india.in

Date - 1/10/ 2022

TRAINING CERTIFICATE

This is to certify that, **Mr.Rohan Rajendra Nagmotti**, of Degree B.Tech ENTC from the College PVPIT Budhgaon has completed Industrial Training in Electro India Sangli in the Period of 1 Sept. 2022 to 30 Sept. 2022. According to this he completed 4 week training.

In the training period we found him a sincere, honest, hardworking, dedicated trainee with a professional attitude and very good job knowledge. In this duration we gave him training of all types of weighing machines in two sections namely hardware section and software section . We found him work satisfactory because of his sincerity, dedication and hard work.

We have found him to be a self starter who is new invention view. We wish him all the best and success in future career.

For Electro-India

(Authorized Signatory)



SMH

MEDITATION SCHOOL INDIA
Stay, Study Practice & Teaching Meditation

CERTIFICATE

O . F . C . O . M . P . L . E . T . I . O . N .

This Certificate Is Presented To

SHREYAS PATIL

This is to certify that Shreyas Patil has successfully completed his internship with Shree Mahesh Heritage during the month of May

During the period, he handled Data Entry Position for our company. During the course of internship, He has shown great amount of responsibility, sincerity and a genuine willingness to learn and zeal to take on new assignments & challenges in particular, his coordination skills and communication skills are par excellence and his attention to details is impressive.

We wish him all the very best for his future

05/06/2022

Date



2022

Pulkit Gupta
Founder



ENVITECHENGINEERINGSERVICES

11 New Road, Farvia, Plot No. 21, Sector 8, Kundli, Gurgaon, Haryana, INDIA

2019-2020

envitech@envitech.com | www.envitech.com

CERTIFICATE

This is to certify that Mr. Netaji Shivaji Sawant,

He has completed 1 month of Industrial Training in production department
From 01/09/2022 to 30/10/2022 with great sincerity, punctuality and
enthusiastically.

We wish him best of luck for him future.

Thanking you

Sumit



Mr. Sumit Nakate
Envitech Engineering Services
7972469504



ELECTRO - INDIA
Eun. Naga & Nagah

MANUFACTURER, SALES & SERVICES OF
ELECTRONIC WEIGHING MACHINE
An ISO 9001:2008 Certified Company

LG ELECTRO INDUSTRIES

CORPORATE OFFICE

PLOT NO. 20, GHANSHYAM NAGAR, MADHANAGAR ROAD,
SANGLI - 416 416 (MAHARASHTRA) PH. 0233-2314242

Email : electroindia1@gmail.com | electroindianindustries@gmail.com

Mobile : 9422508828, 9422409458 | www.electro-india.in

Date - 7/10/2022

TRAINING CERTIFICATE

This is to certify that, **Mr.Prashanth Subhash Nikam.of Degree B.Tech ENTC** from the College **PVPT Budhgaon** has completed Industrial Training in **Electro India Sangli** in the Period of **5 Sept. 2022 to 5 Oct. 2022.**According to this he completed **4 week** training.

In the training period we found him a sincere, honest, hardworking, dedicated trainee with a professional attitude and very good job knowledge. In this duration we gave him training of all types of weighing machines in two sections namely hardware section and software section . We found him work satisfactory because of his sincerity, dedication and hard work.

We have found him to be a self starter who is new invention view. We wish him all the best and success in future career.

For Electro-India

(Authorized Signatory)





ELECTRO - INDIA
From Nitya to Nitya

MANUFACTURER, SALES & SERVICES OF
ELECTRONIC WEIGHING MACHINE
An ISO 9001:2008 Certified Company
LG ELECTRO INDUSTRIES

CORPORATE OFFICE
PLOT NO. 20 GHANSHYAM NAGAR, MADHAVNAGAR ROAD,
SANGLI - 416 416, (MAHARASHTRA) PH - 0233-2314242
Email : electroindia14@gmail.com & electroindiaindustries@gmail.com
Mobile : 9422508828, 9422409458 & www.electro-india.in

Date - 7/10/2022

TRAINING CERTIFICATE

This is to certify that, **Mr.Amol Dhondiram Hanbar** of Degree **B.Tech ENTIC** from the College **PVPIIT Budhgaon** has completed **Industrial Training** in **Electro India Sangli** in the Period of **5 Sept. 2022 to 5 Oct. 2022**. According to this he completed **4 week** training.

In the training period we found him a sincere, honest, hardworking, dedicated trainee with a professional attitude and very good job knowledge. In this duration we gave him training of all types of weighing machines in two sections namely hardware section and software section . We found him work satisfactory because of his sincerity, dedication and hard work.

We have found him to be a self starter who is new invention view. We wish him all the best and success in future career.

For Electro-India

(Authorized Signatory)



संपूर्ण प्रत्येक प्रकार का मशीन

Roll no.18



Vaishnavi Thorbole Cybersecurity Engineering Virtual Internship Program

Certificate of Completion

June 1th-June 30th, 2022

Over the period of June 2022, Vaishnavi Thorbole has completed practical tasks in:

- Protect the keys to the kingdom! Gone Phishing
- Harden your system!
- Final analysis and recommendations

Renata J. Dohmen
Global Head of Early Career
Talent Attraction at SAP

Tom Brunskill
CEO, Co-Founder of Forage

Roll no 19



CERTIFICATE

This is to certify that Mr. Basavaraj Sadashiv Hipparagi.
He has completed 1 month of Industrial Training in production department
From 01/09/2022 to 30/10/2022 with great sincerity , punctuality and
enthusiastically.

We wish him best of luck for him future.

Thanking you



Mr. Sumit Nakate
Envitech Engineering Services
7972469504

SMH

MEITATION SCHOOL INDIA
Stay, Study Practice & Teaching Meditation

CERTIFICATE

O . F . C . O . M . P . L . E . T . I . O . N .

This Certificate Is Presented To

SEJAL DEEPAK GAIKWAD

This is to certify that **Sejal Deepak Gaikwad**, has successfully completed her internship with Shree Mahesh Heritage during the month of **May**.

During the period, **She** handled Data Entry Position for our company.

During the course of internship, **She** has shown great amount of responsibility, sincerity and a genuine willingness to learn and zeal to take on new assignments & challenges. In particular, **her** coordination skills and communication skills are par excellence and **her** attention to details is impressive.

We wish **her** all the very best for **her** future.

10/11/2022

Date



Pkg

Pulkit Gupta
Founder

G.S.

CONTROLSET

35 / 1, Shanivar Peth,
Madhavagar 416 406

Dist:- Sangli, Maharashtra

E-mail :- gsecontrolset@gmail.com
mob :- 9890594051

Date 5 / 10 / 22

Training Certificate

*This is to certify That, **Neha Shashikant Gophane**
from **B.Tech of the College PVPIT Budhgaon** has completed
Industrial Training at our workshop during the Period,
from **1 Sept. 2022 to 30 Sept. 2022.***

*In the training period we found him / her a sincere, honest, hardworking,
dedicated trainee with a professional attitude and very good job knowledge.*

In this duration we gave him / her training of PCB Designing & Testing.

We found his / her work satisfactory because of dedication and hard work.

Regards,

G. S. Karandikar

call 9860875917

G. S. CONTROLSET,

G. S. Karandikar
Proprietor

G.S.

CONTROLSET

35 / 1, Shantwar Peth,
Madhavnagar 416 406
Dist:- Sangli, Maharashtra
E-mail :- gcontrols8@gmail.com
mob :- 9890594051

Date S / 10 / 22

Training Certificate

*This is to certify That, Deepak Ashok Naik
from **B.Tech of the College PVPIT Budhgaon** has completed
Industrial Training at our workshop during the Period,
from **1 Sept. 2022 to 30 Sept. 2022.***

*In the training period we found him / her a sincere, honest, hardworking,
dedicated trainee with a professional attitude and very good job knowledge.*

In this duration we gave him / her training of PCB Designing & Testing.

We found his / her work satisfactory because of dedication and hard work.

Regards,
G. S. Karandikar
call 9860875917

G S CON CONTROLSET

G S CON CONTROLSET

G.S.

CONTROLSET

35 / 1, Shaniwar Peth,
Madhavnagar-416 406
Dist:- Sangli, Maharashtra

E-mail :- gscontrols8@gmail.com
mob :- 9890594051

Date: 5 / 10 / 22

Training Certificate

*This is to certify That, **Pranali Prashant Patil**
from **B.Tech of the College PVPIT Budhgaon** has completed
Industrial Training at our workshop during the Period,
from **1 Sept. 2022 to 30 Sept. 2022.***

*In the training period we found him /her a sincere, honest, hardworking,
dedicated trainee with a professional attitude and very good job knowledge.*

In this duration we gave him /her training of PCB Designing & Testing.

We found his /her work satisfactory because of dedication and hard work.

Regards,

G. S. Karandikar
call 9860875917

G. S. CONTROLSET.
Akarandikar
Proprietor

G.S.

CONTROLSET

35 / 1, Shaniwar Path,
Madhavnagar 416 406
Dist:- Sangli, Maharashtra
E-mail :- gscontrolset8@gmail.com
mob :- 9890594051

Date S / 10 / 22

Training Certificate

*This is to certify That, Sarthavi Rajendra Patil
from **B.Tech of the College PVPT Budhgaon** has completed
Industrial Training at our workshop during the Period,
from **1 Sept. 2022 to 30 Sept. 2022.***

*In the training period we found him / her a sincere, honest, hardworking,
dedicated trainee with a professional attitude and very good job knowledge.*

In this duration we gave him / her training of PCB Designing & Testing.

We found his / her work satisfactory because of dedication and hard work.

Regards,
G. S. Karandikar
call 9860875917

G.S. CONTROLSET,

Proprietor

G.S.

CONTROLSET

35 / 1, Shantivar Peth,
Madhavnagar-416 406
Dist:- Sangli, Maharashtra
E-mail :- gcontrolset@gmail.com
mob :- 9890594051

Date 5/10/22

Training Certificate

*This is to certify That, Shruti Shivshant Mali
from **B.Tech of the College PVPIT Budhgaon** has completed
Industrial Training at our workshop during the Period,
from 1 Sept. 2022 to 30 Sept. 2022.*

*In the training period we found him / her a sincere, honest, hardworking,
dedicated trainee with a professional attitude and very good job knowledge.*

In this duration we gave him / her training of PCB Designing & Testing.

We found his / her work satisfactory because of dedication and hard work.

Regards,

G. S. Karandikar
call 9860875917

G. S. CONTROLSET,

Proprietor

G.S.

CONTROLSET

35 / 1, Shaniwar Peth,
Madhavnagar 416 406

Dist:- Sangli, Maharashtra

E-mail :- gsecontrolset@gmail.com
mob :- 9890594051

Date 5/16 / 22

Training Certificate

*This is to certify That, **Snehal Suresh Patil**
from **B.Tech of the College PVPT Budhgaon** has completed
Industrial Training at our workshop during the Period,
from **1 Sept. 2022 to 30 Sept. 2022.***

*In the training period we found him /her a sincere, honest, hardworking,
dedicated trainee with a professional attitude and very good job knowledge.*

In this duration we gave him / her training of PCB Designing & Testing.

We found his /her work satisfactory because of dedication and hard work.

Regards,
G. S. Karandikar
call 9860875917

G. S. CONTROLSET

Proprietor

G.S.

CONTROLSET

35 / 1, Shanivar Peth,
Madhavnagar 416 406
Dist:- Sangli, Maharashtra

E-mail :- gcontrolset@gmail.com
mob :- 9890594051

Date 5 / 10 / 22

Training Certificate

*This is to certify That, **Anuja Namdev Mali**
from **B.Tech of the College PVPT Budhgaon** has completed
Industrial Training at our workshop during the Period,
from **1 Sept. 2022 to 30 Sept. 2022.***

*In the training period we found him / her a sincere, honest, hardworking,
dedicated trainee with a professional attitude and very good job knowledge.
In this duration we gave him / her training of PCB Designing & Testing.
We found his / her work satisfactory because of dedication and hard work.*

Regards,

G. S. Karandikar
call 9860875917

G. S. CONTROLSET,

Proprietor

G.S.

CONTROLSET

35 / 1, Shaniwar Peth,
Madhavnagar 416 406
Dist:- Sangli, Maharashtra

E-mail :- gscontrols8@gmail.com
mob :- 9890594051

Date 5 / 10 / 22

Training Certificate

*This is to certify That, **Sakshi Rajendra Bhatnare**
from **B.Tech of the College PVPT Budhgaon** has completed
industrial Training at our workshop during the Period,
from **1 Sept. 2022 to 30 Sept. 2022.***

*In the training period we found him /her a sincere, honest, hardworking,
dedicated trainee with a professional attitude and very good job knowledge.*

In this duration we gave him /her training of PCB Designing & Testing.

We found his /her work satisfactory because of dedication and hard work.

Regards,
G. S. Karandikar
call 9860875917

G. S. CONTROLSET

Proprietor



ELECTRO - INDIA

Km. 11/4 to 11/4/2

MANUFACTURER, SALES & SERVICES OF
ELECTRONIC WEIGHING MACHINE
An ISO 9001:2008 Certified Company

LG ELECTRO INDUSTRIES

CORPORATE OFFICE

PLOT NO. 20, CHANSHYAM NAGAR, MADHANAGAR ROAD,
SANGLI - 416 416 (MHARASHTRA) Ph. 0233-234242

Email : electroindia14@gmail.com ■ electroindiaindustries@gmail.com

Mobile : 9422506828, 9422409458 ■ www.electro-india.in



Date – 1/10/ 2022

TRAINING CERTIFICATE

This is to certify that **Mr.Pratik Mohan Patil** of Degree B.Tech ENTIC from the College PVRT Budnagaon has completed Industrial Training in Electro India Sangli in the Period of 1 Sept. 2022 to 30 Sept. 2022. According to this he completed 4 week training.

In the training period we found him a sincere, honest, hardworking, dedicated trainee with a professional attitude and very good job knowledge. In this duration we gave him training of all types of weighing machines in two sections namely hardware section and software section . We found him work satisfactory because of his sincerity, dedication and hard work.

We have found him to be a self starter who is new invention view. We wish him all the best and success in future career.

For Electro-India

(Authorized Signatory)



G.S.

CONTROLSET

35 / 1, Shanivar Peth,
Madhavnagar 416 406
Dist:- Sangli, Maharashtra
E-mail :- gscontrolsk@gmail.com
mob :- 9890594051

Date 6 / 10 / 2022

Training Certificate

*This is to certify That, Vaishnavi Shivraj Patil
from **B.Tech of the College PVPIT Budhgaon** has completed
industrial Training at our workshop during the Period,
from **1 Sept. 2022 to 30 Sept. 2022.***

*In the training period we found him / her a sincere, honest, hardworking,
dedicated trainee with a professional attitude and very good job knowledge.*

In this duration we gave him / her training of PCB Designing & Testing.

We found his / her work satisfactory because of dedication and hard work.

Regards,

G. S. Karandikar
call 9860875917

G.S. CONTROLSET

Proprietor



ELECTRO - INDIA

Kar. M. & M. & M.

MANUFACTURER, SALES & SERVICES OF
ELECTRONIC WEIGHING MACHINE
An ISO 9001:2008 Certified Company

LG ELECTRO INDUSTRIES

CORPORATE OFFICE

PLOT NO. 20, GHANSHYAM NAGAR, MADHANAGAR ROAD,
SANGLI - 416 416. (MH/MR/SHT/RA) PH. 0233-2314242

Email : electroindia14@gmail.com ■ electroindianindustries@gmail.com

Mobile : 9422596820, 9422409458 ■ www.electro-india.in

Date - 1/10/2022

TRAINING CERTIFICATE

This is to certify that, **Mr. Vinit Vikas Mule, of Degree B.Tech** ENTC from the College **PV/PT Budhgaon** has completed **Industrial Training** in **Electro India Sangli** in the **Period of 1 Sept. 2022 to 30 Sept. 2022**. According to this he completed **4 week training**.

In the training period we found him a sincere, honest, hardworking, dedicated trainee with a professional attitude and very good job knowledge. In this duration we gave him training of all types of weighing machines in two sections namely hardware section and software section . We found him work satisfactory because of his sincerity, dedication and hard work.

We have found him to be a self starter who is new invention view. We wish him all the best and success in future career.

For Electro-India

(Authorized Signatory)

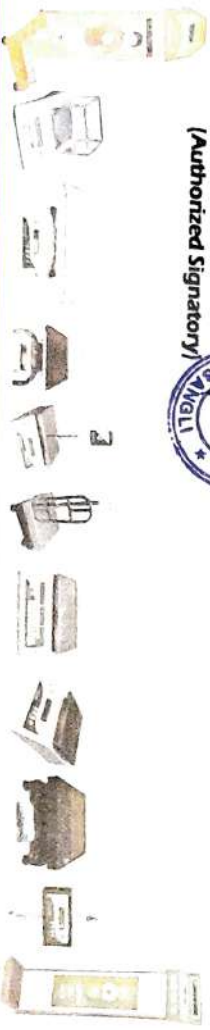



ELECTRO - INDIA

For Weigh to Weigh

MANUFACTURER, SALES & SERVICES OF
ELECTRONIC WEIGHING MACHINE
An ISO 9001 2008 Certified Company
LG ELECTRO INDUSTRIES

CORPORATE OFFICE

PLOT NO. 20, GHANSHYAM NAGAR, MADHWANGAR ROAD,
SANGLI - 416 416. (MAHARASHTRA) PH : 0233 2314242

Email : electroindia14@gmail.com ■ electroindustries@gmail.com

Mobile : 9422906828, 9422409458 ■ www.electro-india.in

Date - 1/10/2022

TRAINING CERTIFICATE

This is to certify that, **Mr.Prashant Rajaram kodag,of Degree B.Tech ENTC from the College PVRPT Buddhaon** has completed Industrial Training in **Electro India Sangli** in the Period of **1 Sept. 2022 to 30 Sept. 2022.**According to this he completed **4 week** training.

In the training period we found him a sincere, honest, hardworking, dedicated trainee with a professional attitude and very good job knowledge. In this duration we gave him training of all types of weighing machines in two sections namely hardware section and software section . We found him work satisfactory because of his sincerity, dedication and hard work.

We have found him to be a self starter who is new invention view. We wish him all the best and success in future career.

For Electro-India

(Authorized Signatory)

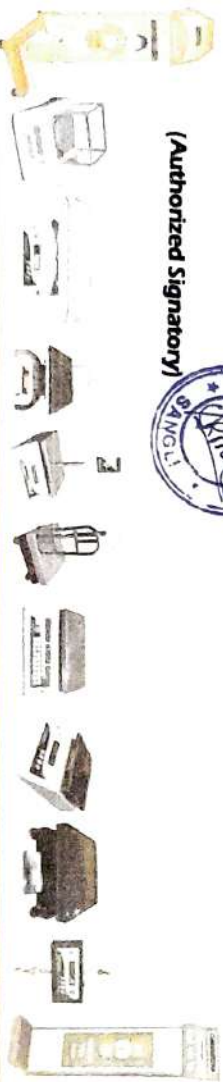



ELECTRO - INDIA

Run. Weigh. to Weigh.

MANUFACTURER, SALES & SERVICES OF
ELECTRONIC WEIGHING MACHINE
An ISO 9001:2008 Certified Company
LG ELECTRO INDUSTRIES

CORPORATE OFFICE

PLOT NO. 20, CHANSHYAM NAGAR, MADHANAGAR ROAD,
SANGLI - 416 416 (MAHARASHTRA) PH. :0233-2314242

Email : electroindia4@gmail.com ■ electroindiaindustries@gmail.com

Mobile : 9427506878, 9427409458 ■ www.electro-india.in

TRAINING CERTIFICATE

Date - 1/10/2022

This is to certify that, Miss.Shweta Sudhir Kognole-of Degree B.Tech ENTC from the College PVPTI Budhgaon has completed Industrial Training in Electro India Sangli in the Period of 1 Sept. 2022 to 30 Sept. 2022.According to this she completed 4 week training.

In the training period we found her a sincere, honest, hardworking, dedicated trainee with a professional attitude and very good job knowledge. In this duration we gave her training of all types of weighing machines in two sections namely hardware section and software section . We found her work satisfactory because of her sincerity, dedication and hard work.

We have found her to be a self starter who is new invention view. We wish her all the best and success in future career.

For Electro-India

(Authorized Signatory)





ENVITECHENGINEERINGSERVICES

B-504, Phara Complex, Plot No. 27, Sector 8 Kamathia, Panvel Road, Maharashtra 410206

8 9770283665

envitechengineerservices@gmail.com

CERTIFICATE

This is to certify that Miss. Priyanka Rajaram Mali.
She has completed 1 month of Industrial Training in production department
From 01/09/2022 to 30/10/2022 with great sincerity , punctuality and
enthusiastically.
We wish her best of luck for her future.

Thanking you



Sumit Nakate

Mr. Sumit Nakate
Envitech Engineering Services
7972469504

9770283665

G.S.

CONTROLSET

35 / 1, Shanivar Peth,
Madhavnagar 416 406
Dist:- Sangli, Maharashtra

E-mail :- gscontrolset@gmail.com
mob :- 9890594051

Date 5/10/2022

Training Certificate

*This is to certify That, **Swapnil Sanjay Patil**
from **B.Tech of the College PVPT Budhgaon** has completed
Industrial Training at our workshop during the Period,
from **1 Sept. 2022 to 30 Sept. 2022.***

*In the training period we found him / her a sincere, honest, hardworking,
dedicated trainee with a professional attitude and very good job knowledge.*

In this duration we gave him / her training of PCB Designing & Testing.

We found his / her work satisfactory because of dedication and hard work.

Regards,

G. S. Karandikar
call 9860875917

G. S. CONTROLSET

G. S. Karandikar
Proprietor



Younity Community LLP
LLPIN - AAU/0131

Younity.in

CERTIFICATE OF EXCELLENCE

this certificate is proudly presented to

Prathamesh Daryappa Kumbhar

for successfully completing the Corporate Training Course in the month of October, 2022 for the period of 21 Days. During the tenure of the course, you displayed creative vision and strong problem-solving skills.

We wish you all the best for your future endeavours !

MR PRAFFUL GARG
FOUNDER & CEO
YOUNITY IN

#startupindia



GaiKwad Sales & Service Private Limited,
Tara Complex, Near Bus Stand, Khanapur,
Tal - Tasgaon, Dist - Sangli, Pincode:- 415307.
Proprietor- Mr. Sanbhaji Shivaji GaiKwad.
+91 9765574890

15 Dec 2022.

TO WHOMSOEVER IT MAY CONCERN

It is certified that **Mr. Arjun Almaram Suryawanshi** was under the employer of **GaiKwad Sales & Service** as **Senior Electrician Engineer** in Electrical and Maintenance Department from 12/10/2022 to 15/12/2022. He was a full-time employee working and 45 Day working as a Technician at Khanapur, Tal:- Khanapur, Dist:- Sangli.

As an Senior Electrician Engineer. His duties were

- Team Leader at Electrical Safety Audit and Design.
- Electrical Design Planning and Evaluation.
- Report Making In Electrical Maintenance in Infrastructure Model.
- Electrical Engineering Consultancy.
- Maintenance Of Consumer Appliances.

We also certify that he is involved in any activity or associated with element subversive to the state or of discipline. We wish him all success in the future

Arjun Almaram Suryawanshi
9765574890



SACREATIVE TECHNOLOGY PRIVATE LIMITED

Regd. Off.: C/O MANSUR MAHAMADKHAN PATHAN, H.NO-05

POST-BUDHAGAON, TAL - MIRAJ DIST-SANGLI

SANGLI Sangli, MH 416304 IN

(CIN: U72900PN2022PTC211295)

Email Id: sacreative@technology2022@gmail.com, Contact Details: 8275751063.

10 - August - 2022.

TO WHOMSOEVER IT MAY CONCERN

This is to certify that, Mr. Aniket Vilas Patil, was completed industrial training in our company from 10th July 2022 to 9th August 2022.

His responsibilities included working on the hardware parts of our different products and embedded coding for our products. His exposure in these areas is very good. During her tenure with us, he ably handled his responsibilities very well and we found him to be of good character and hardworking. We found his work satisfactory because of her sincerity, dedication, and hard work.

We have found him to be a self-starter who is a new invention view. We wish him all the best and success in his future career endeavours.

Thanking You,



A CREATIVE TECHNOLOGY PVT. LTD.

(Signature)
Director

(Signature)
Director

G.S.

CONTROLSET

35 / 1, Shanwar Peth,
Madhavnagar 416-406
Dist.: Sangli, Maharashtra
E-mail :- gsecontrolset@gmail.com
mob :- 9890594051

Date 5 / 10 / 2022

Training Certificate

*This is to certify That, Vrushali Vasant Shinde
from **B.Tech of the College PVPIT Budhgaon** has completed
industrial Training at our workshop during the Period,
from **1 Sept. 2022 to 30 Sept. 2022.***

*In the training period we found him / her a sincere, honest, hardworking,
dedicated trainee with a professional attitude and very good job knowledge.*

In this duration we gave him / her training of PCB Designing & Testing.

We found his / her work satisfactory because of dedication and hard work.

Regards,
G. S. Karandikar
call 9860875917

G.S. CONTROLSET,

Proprietor

M/S. SHANKAR SARGAR ENGINEERING

Manufacturer, Sales & Services of Electronic Weighing Machine.

Plot No.107,Vasantdada Industrial state, Sangli.

Tel : (0233) 2312972, 2314623.

Mob.:- 9422406972

Date: 12/09/2022

Our Industry M/S. Shankar Sargar Engineering Manufactures
& Sales of Weighing Machines. This is certifying to **Miss. Shinde**
Mayuri Siddheshwar student of P. V.P.I.T. college of Engg.

Budhgaon (E& TC – BE Engg.) has completed 2 Months training
session during the period of 15/08/2022 to 12/09/2022 satisfactorily.

During the training period her behavior was suitable to the
industrial environment she seeks the training on her own.

Authorized

For M/s. SHANKAR SARGAR ENGINEERING,

Partner



ELECTRO - INDIA
Electro-India is the Best

MANUFACTURER, SALES & SERVICES OF
ELECTRONIC WEIGHING MACHINE
An ISO 9001:2008 Certified Company
LG ELECTRO INDUSTRIES

CORPORATE OFFICE
PLOT NO. 20, GHANSHYAM NAGAR, MADHANAGAR ROAD,
SANGLI - 416 416 (MAHARASHTRA) PH : 0233-2314242
Email : electroindia14@gmail.com ■ electroindiaindustries@gmail.com
Mobile : 9425906928, 9422409458 ■ www.electro-india.in

Date – 7/10/2022

TRAINING CERTIFICATE

This is to certify that, **Miss. Vaishnavi Chandrakant Nalawade**, of Degree **B.Tech ENTIC** from the College **PVPT Budgaon** has completed **Industrial Training** in **Electro India Sangli** in the **Period of 5 Sept. 2022 to 5 Oct. 2022**. According to this she completed **4 week training**.

In the training period we found her a sincere, honest, hardworking, dedicated trainee with a professional attitude and very good job knowledge. In this duration we gave her training of all types of weighing machines in two sections namely hardware section and software section. We found her work satisfactory because of her sincerity, dedication and hard work.

We have found her to be a self starter who is new invention view. We wish her all the best and success in future career.

For Electro-India



(Authorized Signatory)



ELECTRO - INDIA

Est. 1974, in 1974

MANUFACTURER, SALES & SERVICES OF
ELECTRONIC WEIGHING MACHINE
An ISO 9001:2008 Certified Company

LG ELECTRO INDUSTRIES

CORPORATE OFFICE

PLOT NO. 20, CHANSHYAM NAGAR, MADHWANGAR ROAD,
SANGLI - 416 416 (MAHARASHTRA) PH. 0233-2314242

Email : electroindia14@gmail.com | electroindiaindustries@gmail.com

Mobile : 9422969828, 9422409458 | www.electro-india.in

Date - 7/10/2022

TRAINING CERTIFICATE

This is to certify that, Miss. Sakshi Santosh Jagdale, of Degree B.Tech ENTIC from the College PVPPT Budhgaon has completed Industrial Training in Electro India Sangli in the Period of 5 Sept. 2022 to 5 Oct. 2022. According to this she completed 4 week training.

In the training period we found her a sincere, honest, hardworking, dedicated trainee with a professional attitude and very good job knowledge. In this duration we gave her training of all types of weighing machines in two sections namely hardware section and software section . We found her work satisfactory because of her sincerity, dedication and hard work.

We have found her to be a self starter who is new invention view. We wish her all the best and success in future career.

For Electro-India

(Authorized Signatory)

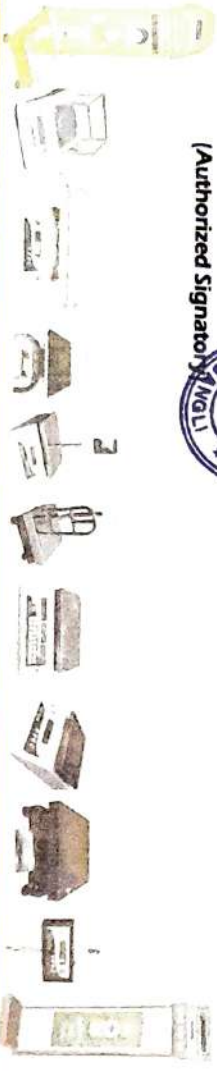

आपला प्रत्येक ग्राहक हमारा... सर्वोत्तम स्थिति...!

Roll no. 43



ENVITECHENGINEERINGSERVICES

0-504, Dnara Temple, Plot No. 21, Sector 8, Kamathe, Jambh. Bargarh, Maharashtra - 480206

☎ 9770883645

✉ envitechengineeringervices@gmail.com

CERTIFICATE

This is to certify that Miss. Prajкта Murlidhar Mane.
She has completed 1 month of Industrial Training in production department
From 01/09/2022 to 30/10/2022 with great sincerity , punctuality and
enthusiastically.

We wish her best of luck for her future.

Thanking you



Mr. Sumit Nakate
Envitech Engineering Services
7972469504

M/S. SHANKAR SARGAR ENGINEERING

Manufacturer, Sales & Services of Electronic Weighing Machine.

Plot No.107,Vasantdada Industrial state, Sangli.
Tel : (0233) 2312972, 2314623.
Mob.: 9422406972

Date: 12/09/2022

Our Industry M/S. Shankar Sargar Engineering Manufactures & Sales of Weighing Machines. This is certifying to **Miss. Akanksha Adhikkumar Khemlapure** student of P. V.P.I.T. college of Engg. Budhgaon (B.Tech) has completed 2 Months training session during the period of 15/08/2022 to 12/09/2022 satisfactorily.

During the training period her behavior was suitable to the industrial environment she seeks the training on her own.

Authorized

For M/s. SHANKAR SARGAR ENGINEERING,
Partner



ENVITECHENGINEERINGSERVICES

F-504, Bhowa Complex, Plot No. 21, Sector E, Kanoohar, Panvel, Raigadh, Maharashtra 410206

9770431445

envitechengineering@gmail.com

CERTIFICATE

This is to certify that Miss. Prajakta Balu shishte.

She has completed 1 month of Industrial Training in production department
From 01/09/2022 to 30/10/2022 with great sincerity ,punctuality and
enthusiastically.

We wish her best of luck for her future.

Thanking you



Signature

Mr. SumitNakate

Envitech Engineering Services

7972469504



A-30, Kadal, Hadkarnode 7,
Sur AMDC,
Kolhapur-416216
Ph: 0234 2463251
microtech_ket@gmail.com

Date - 01/10/2022

CERTIFICATE OF COMPLETION

This is to certify that

Pramod Pravin Walhare,

Has successfully completed training in

Industry Automation using PLC and HMI at MICROTECH, Kolhapur.

From - 01/09/2022 To 30/09/2022



For Authorized

Digital Signature





S ELECTRICAL

Manufacturers & Supplier of MSEDCL, H/T/L/T Line Material

Ref No. :

Date : 01/10/2022

TO WHOMSOEVER IT MAY CONCERN

This is to certify that, **MS. Kshitija Anil Kulkarni** Student of Bachelor Of **Electronics & Telecommunication Engineering** from **Padmabhooshan Vasantnradada Patil Institute of Technology Buddhaon**, had undergoes industrial training from 01th September 2022 to 30th September 2022 in our organization.

During this training period he was found to be punctual, sincere and hard working in his work

We wish him success from our team for his good future life.

For S ELECTRICAL

Authorised Signature

Handwritten signature
01/10/2022



Mob. 9098436859
9657728578

Gat. No. 925, Plot No. 86, M.I.D.C.
Kanerwadi Road, A/P. Savali, Tal. Miraj,
Dist. Sangli 416410 (Mah.) Ph. (0233) 9437781
Web : www.selectrical.in
Email : selectrical4@gmail.com

Roll No. 48

दुरध्वनी : ०२३३/२३०१७४५, २३०५८६०
e-mail - sdo1252@ha.mahadis.com.in
website- www.mahadiscom.in

महाविांतरण
(महाराष्ट्र शासन अांकित)
CIN: U40109MH2005SGC153645

उपकार्यकारी अभियंता यांचे कार्यालय
राज्य विश्रामबाग उर्ध्वतन्त्रालय,
विश्रामबाग सांगली 416415.
ता. भिरज नि. सांगली.

जा.क्रं उपकार्य.अभि/वि.बाग/मासंवि/ No-2299

दिनांक 27-06-2022

दाखला

दाखला देणेत येतो की, कु.मृणाल सुनिल दानेकर, TV BTech (पी.व्ही.पी. इन्स्टिट्यूट बुधगाव) ही उपविभाग विश्रामबाग अंतर्गत 33/11 के.व्ही. उपकेंद्र येथे (शाखा कार्यालय कवलापूर) या ठिकाणी दि. 26.05-2022 ते 23-06-2022 अखेर 28 दिवसाचे प्रशिक्षण पूर्ण केले आहे.

सदरचा दाखला हा तिच्या दिनांक 24-06-2022 रोजीच्या विनंती अर्जानुसार प्रशिक्षण पूर्ण केले म्हणून देणेत येत आहे.केले म्हणून देणेत येत आहे.

(के.रा.बळगाव)

उपकार्यकारी अभियंता

म.रा.वि.वि.के.मर्या.

उपविभाग विश्रामबाग

प्रती,

कु.मृणाल सुनिल दानेकर

TV BTech

G.S.

CONTROLSET

35 / 1, Shanwar Peth,
Madhavnagar 416 406
Dist:- Sangli, Maharashtra
E-mail :- gscontrolset8@gmail.com
mob :- 9890594051

Date 5 / 10 / 2022

Training Certificate

*This is to certify That, Priyanka Bharat Mali
from **B.Tech of the College PVPT Budhgaon** has completed
industrial Training at our workshop during the Period,
from **1 Sept. 2022 to 30 Sept. 2022.***

*In the training period we found him / her a sincere, honest, hardworking,
dedicated trainee with a professional attitude and very good job knowledge.*

In this duration we gave him / her training of PCB Designing & Testing.

We found his / her work satisfactory because of dedication and hard work.

Regards,
G. S. Karandikar
call 9860875917

G.S. CONTROLSET,

Proprietor



ELECTRO - INDIA
Est. May, 1984

MANUFACTURER, SALES & SERVICES OF
ELECTRONIC WEIGHING MACHINE
An ISO 9001:2008 Certified Company
LG ELECTRO INDUSTRIES

CORPORATE OFFICE

PLOT NO. 20, GHANSHYAM NAGAR, MADHAVNAGAR ROAD,

SANGLI - 416 016 (MAHARASHTRA) PH. 0233-2314242

Email : electroindia1@gmail.com ■ electroindustries@gmail.com

Mobile : 9422509828, 9422409458 ■ www.electro-india.in

TRAINING CERTIFICATE

Date - 7/10/2022

This is to certify that, Miss. Mrunal Manik Suryawanshi of Degree B.Tech ENTIC from the College PVPIT Budhgaon has completed Industrial Training in Electro India Sangli in the Period of 5 Sept. 2022 to 5 Oct. 2022. According to this she completed 4 week training.

In the training period we found her a sincere, honest, hardworking, dedicated trainee with a professional attitude and very good job knowledge. In this duration we gave her training of all types of weighing machines in two sections namely hardware section and software section . We found her work satisfactory because of her sincerity, dedication and hard work.

We have found her to be a self starter who is new invention view. We wish her all the best and success in future career.

For Electro-India

(Authorized Signatory)



अपना प्रत्येक श्रेय रक्षवा!...नेवरो श्रिया...!

Roll no 51



ELECTRO - INDIA

Electro-India is Unique

MANUFACTURER, SALES & SERVICES OF
ELECTRONIC WEIGHING MACHINE
An ISO 9001:2008 Certified Company
LG ELECTRO INDUSTRIES

CORPORATE OFFICE

PLOT NO. 20, GHANSHYAM NAGAR, MADHANAGAR ROAD,
SANGLI - 416 416 (MAHARASHTRA) PH - 0233-2314242

Email : electroindia1@gmail.com ■ electroindiaindustries@gmail.com

Mobile : 9422509828, 9422409459 ■ www.electro-india.in

TRAINING CERTIFICATE

Date - 7/10/ 2022

This is to certify that, **Mr.Piyush Sajjanrao Yadav** of Degree B.Tech ENTC from the College PV/PT Budhgaon has completed Industrial Training in Electro India Sangli in the Period of 5 Sept. 2022 to 5 Oct. 2022. According to this he completed 4 week training.

In the training period we found him a sincere, honest, hardworking, dedicated trainee with a professional attitude and very good job knowledge. In this duration we gave him training of all types of weighing machines in two sections namely hardware section and software section . We found him work satisfactory because of his sincerity, dedication and hard work.

We have found him to be a self starter who is new invention view. We wish him all the best and success in future career.

For Electro-India

(Authorized Signatory)

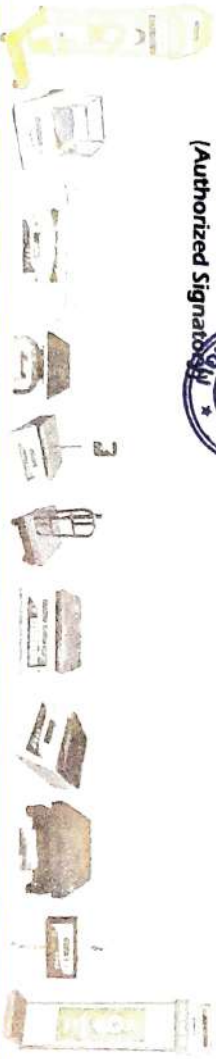

अपना प्रत्येक प्रश्न हलवा...संगली सिंगल

Roll no.52



ELECTRO - INDIA
Electronics, India

MANUFACTURER, SALES & SERVICES OF
ELECTRONIC WEIGHING MACHINE
An ISO 9001:2008 Certified Company
LC ELECTRO INDUSTRIES

CORPORATE OFFICE

Plot No 20, Changanara Nagar, Mahabubnagar P.O.,
Sangli - 418 416 (Maharashtra), PH: 0233214442
Email: electroindia@gmail.com | electro@lc-electroindia.com
Mobile: 9423596282 | 9422495456 | www.electroindia.in

Date - 1/10/ 2022

TRAINING CERTIFICATE

This is to certify that, **Mr. Vishwas Tukaram Madane**, of Degree B.Tech ENTC from the College PVPIIT Budhgaon has completed Industrial Training in Electro India Sangli in the Period of 1 Sept. 2022 to 30 Sept. 2022. According to this he completed 4 week training.

In the training period we found him a sincere, honest, hardworking, dedicated trainee with a professional attitude and very good job knowledge. In this duration we gave him training of all types of weighing machines in two sections namely hardware section and software section. We found him work satisfactory because of his sincerely, dedication and hard work.

We have found him to be a self starter who is new invention view. We wish him all the best and success in future career.

For Electro-India

(Authorized Signatory)



संगणक प्रणाली आणि मशीन

Roll no 53

Certificate of Training

Omkar Bhandare

from Padmabhooshan Vasanttraodada Patil Institute Of Technology, Budhgaon, Sangli has successfully completed an 8-week online training on **Programming with C and C++**. The training consisted of Getting Started With Programming in C, Diving Into C Programming, Fundamentals of Object Oriented Programming Using CPP, Diving into CPP Programming, and Building Cricket Game Application modules.

We wish Aniket all the best for future endeavours.

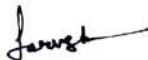

Sarvesh Agarwal

FOUNDER & CEO, INTERNSHALA

Date of certification: 2022-11-05

Certificate no. : F26C4AE4-E93C-2428-8214-0B3D5D7DEE5E

For certificate authentication, please visit https://trainings.internshala.com/verify_certificate



ELECTRO - INDIA

For: *Training, & Repair*

MANUFACTURER, SALES & SERVICES OF
ELECTRONIC WEIGHING MACHINE
An ISO 9001:2008 Certified Company
LG ELECTRO INDUSTRIES

CORPORATE OFFICE

PLOT NO. 20, GHANSHYAM NAGAR, MADHANAGAR ROAD,
SANGLI - 416 416 (MAHARASHTRA) PH: 0233-2314242

Email: electroindia1@gmail.com | electroindiaindustry@gmail.com

Mobile : 9422505620, 9422409458 | www.electro-india.in

Date - 1 /10/ 2022

TRAINING CERTIFICATE

This is to certify that, **Mr.Rushikesh Annaso Barsing** of Degree B.Tech ENTC from the College PVPIT Budhgaon has completed Industrial Training in Electro India Sangli in the Period of 1 Sept. 2022 to 30 Sept. 2022. According to this he completed 4 week training.

In the training period we found him a sincere, honest, hardworking, dedicated trainee with a professional attitude and very good job knowledge. In this duration we gave him training of all types of weighing machines in two sections namely hardware section and software section . We found him work satisfactory because of his sincerity, dedication and hard work.

We have found him to be a self starter who is new invention view. We wish him all the best and success in future career.

For Electro-India

(Authorized Signatory)

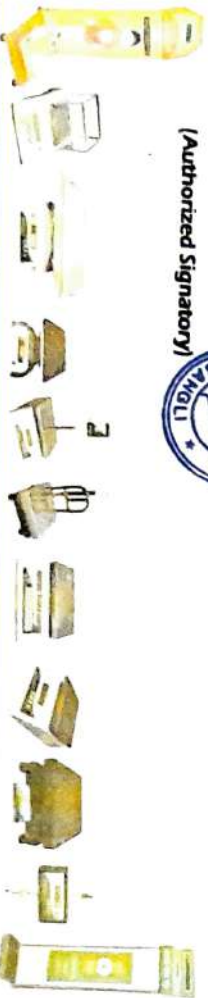

संगणक प्रत्येक प्रश्न हलवावा.....सुखाचा शोधना...!

Roll No 55



A-30 Kood Hubbansole 5
Near AMU,
Kohlapur-416216
Ph:0201 280 9981
microtech_kepk@gmail.com

Date - 01/10/2022

CERTIFICATE OF COMPLETION

This is to certify that

Harshada Bharat Kavathekar,

Has successfully completed training in

Industry Automation using PLC and HMI at MICROTECH, Kohlapur.

From - 01/09/2022 To 30/09/2022



For Authorized

Digital Signature



Schneider
Electric

INNOVANCE

दुरध्वनी : ०२३३/२३०१७४५,२३०५८६०

e-mail - sdo1252@ho.mahadiscom.in

website- www.mahadiscom.in

महावितरण
(महाराष्ट्र शासन अंगीकृत)
CIN: U40109MH2005SGC153645

उपकार्यकारी अभियंता यांचे कार्यालय
संवसु विश्रामबाग उपविभागोय,
विश्रामबाग सांगली 416415.
ता. मिरज जि. सांगली.

जा.क्रं उपकार्य.अभि/वि.बाग/मासंवि/ No-2291

दिनांक 27-06-2022

दाखला

दाखला देणेत येतो की, श्री सम्मेद संजय पाटील, TY BTech (पी.व्ही.पी. इन्स्टिट्यूट बुधगाव) हे उपविभाग विश्रामबाग अंतर्गत 33/11 के.व्ही. उपकेद्र येथे (शाखा कार्यालय कवलापूर) या ठिकाणी दि. 26.05-2022 ते 23-06-2022 अखेर 28 दिवसाचे प्रशिक्षण पूर्ण केले आहे.

सदरचा दाखला हा त्यांच्या दिनांक 24-05-2022 रोजीच्या विनंती अर्जानुसार प्रशिक्षण पूर्ण केले म्हणून देणेत येत आहे.

(के.ए.सी. चव्हाण)

उपकार्यकारी अभियंता
म.रा.वि.वि.कं.मर्या.
उपविभाग विश्रामबाग

प्रती,

सम्मेद संजय पाटील.

TY BTech



A. Anoop Kojal, Haldangate 7,
Sector 29, NCR,
Kohlapur - 410216
Ph: 02027 9106003
microtech kejy@gmail.com

Date - 01/09/2022

CERTIFICATE OF COMPLETION

This is to certify that

Ratnaja Rajendra Shirwadkar,

Has successfully completed training in

Industry Automation using PLC and HMI at MICROTECH, Kohlapur

From - 01/09/2022 To 30/09/2022



For Authorized

Digital Signature



Schneider
Electric

INOVANCE



ELECTRO - INDIA

Real Work, n. World

MANUFACTURER, SALES & SERVICES OF
ELECTRONIC WEIGHING MACHINE
An ISO 9001:2008 Certified Company

LG ELECTRO INDUSTRIES

CORPORATE OFFICE

PLOT NO. 20 GHANSHYAM NAGAR, MADHANAGAR ROAD,
SANGLI - 416 416 (MAHARASHTRA) PH. 0233-2314242

Email: electroindia14@gmail.com | electroindiaindustries@gmail.com

Mobile: 9422598628, 942249459 | www.electro-india.in

Date - 1/10/2022

TRAINING CERTIFICATE

This is to certify that, *Miss Ankita Ramesh Shinde*, of Degree B.Tech ENTC from the College *PV/PIT Budhgaon* has completed Industrial Training in *Electro India Sangli* in the Period of 1 Sept. 2022 to 30 Sept. 2022. According to this she completed 4 week training.

In the training period we found her a sincere, honest, hardworking, dedicated trainee with a professional attitude and very good job knowledge. In this duration we gave her training of all types of weighing machines in two sections namely hardware section and software section. We found her work satisfactory because of her sincerity, dedication and hard work.

We have found her to be a self starter who is new invention view. We wish her all the best and success in future career.

For Electro-India

(Authorized Signatory)

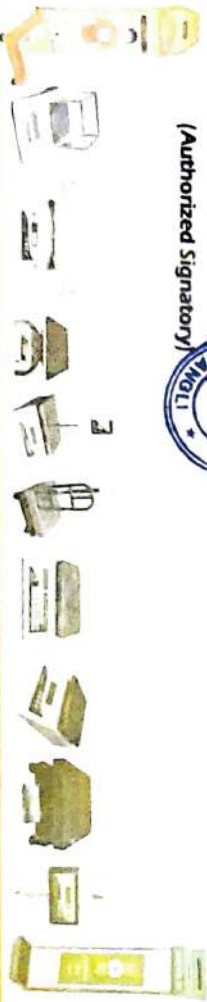

अपूर्णा प्रत्येक रंगे हस्तात्... (रांगरी) इंडिया...!



S ELECTRICAL

Manufacturers & Supplier of MS&DCL, H.T/L, T Line Material

Ref No

Date: 01/10/2022

TO WHOMSOEVER IT MAY CONCERN

This is to certify that, MS. Jyoti Panditrao Patil Student of Bachelor Of Electronics & Telecommunication Engineering from Padmabhooshan Vasantraodada Patil Institute of Technology Budhgaon, had undergoes industrial training from 01st September 2022 to 30th September 2022 in our organization.

During this training period he was found to be punctual, sincere and hard working in his work

We wish him success from our team for his good future life.

For S ELECTRICAL

Authorised Signature



Mob- 9028436859
9657798578

Gate No. 895, Plot No. 86, M.I.D.C.
Karnarwad Road, A/p. Savali, Tal. Murga,
Dist. Sangli 416410. (Mah.) Ph. (0933) 8437281
Web : www.sselectrical.in
Email : selectrical@gmail.com



A-30, Kopal, Haldangadi-5
Sector-MHPC,
Kollhapur-410216
Ph:0251-2407261
microtech.kopt@gmail.com

Date - 01/10/2022

CERTIFICATE OF COMPLETION

This is to certify that

Sanket Ashok Patil,

Has successfully completed training in

Industry Automation using PLC and HMI at MCROTECH, Kollhapur.

From - 01/09/2022 To 30/09/2022



For Authorized

Digital Signature



Schneider
Electric

INOVANCE



ELECTRO - INDIA
Raj. Nagar, Raj. G.

MANUFACTURER, SALES & SERVICES OF
ELECTRONIC WEIGHING MACHINE
An ISO 9001:2008 Certified Company
LG ELECTRO INDUSTRIES

CORPORATE OFFICE

Plot No. 20 (GATE NO. 1) KANHANAGAR, MANHANAGAR ROAD,
GAWAT - 416 416 (MAHARASHTRA) PIN - 422113 (INDIA)

Email : info@electroindia.com ■ electroindia@rediffmail.com

Mobile : 9822506020, 9427409458 ■ www.electroindia.in

TRAINING CERTIFICATE

Date - 1/10/ 2022

This is to certify that, **Miss.Mansi Balaji Patil** of Degree B.Tech ENTC from the College PVPIT Budhgaon has completed Industrial Training in Electro India Sangli in the Period of 1 Sept. 2022 to 30 Sept. 2022. According to this she completed 4 week training.

In the training period we found her a sincere, honest, hardworking, dedicated trainee with a professional attitude and very good job knowledge. In this duration we gave her training of all types of weighing machines in two sections namely hardware section and software section . We found her work satisfactory because of her sincerity, dedication and hard work.

We have found her to be a self starter who is new invention view. We wish her all the best and success in future career.

For Electro-India

(Authorized Signatory)



आपला प्रत्येक ग्रॅम हकावा....इतकेचो श्रेष्ठता....!



SACREATIVE TECHNOLOGY PRIVATE LIMITED

Regd. Off.: C/O MANSUR MAHAMADKHAN PATHAN, H.NO-05

POST-BUDHAGAON, TAL - MIRAJ DIST-SANGLI

SANGLI Sangli. MH 416304 IN

(CIN: U72900PN2022PTC211295)

Email Id: sacreativetechnology2022@gmail.com, Contact Details: 8275751063.

10 - August - 2022.

TO WHOMSOEVER IT MAY CONCERN

This is to certify that, Mr. Om Vinayak Bhokare, was completed industrial training in our company from 10th July 2022 to 9th August 2022.

His responsibilities included working on the hardware parts of our different products and testing of our products. His exposure in these areas is very good. During her tenure with us, he ably handled his responsibilities very well and we found him to be of good character and hardworking. We found his work satisfactory because of her sincerity, dedication, and hard work.

We have found him to be a self-starter who is a new invention view. We wish him all the best and success in his future career endeavors.

Thanking You,



S A CREATIVE TECHNOLOGY PVT. LTD.
P. Prathil
Director

Salmon K. Patil
Director

Dr. V. P. S. S. MS
P. V. P. Institute of Technology Budhagaon
Department of Electronics and Telecommunication
Year 2022-2023

CERTIFICATE

This is to certify that the Mini Project report entitled

"Smart Blind Stick Using Arduino"

Submitted By

Sr. No.	Name	Roll No.	PRN No.
1	Sujeet Prashant Patil	3139	2062691372001
2	Vishwanath Arun Hakke	3140	2062691372026

Is a record of the work done during the academic year 2022-2023 of B.Tech. Degree in ELECTRONIC AND TELECOMMUNICATION ENGINEERING of Padmabooshan Vasantodada Patil Institute of Technology has be carried out by him under our guidance, as an internal guide, satisfactorily.

Place: Budhgaon

Date:

 Guide 
(Prof. R. S. More & Prof. D. O. Shirsath)

HOD
(Dr. M. S. Chavan)

Principal
(Dr. D. V. Ghewade)

Dr. V. P.S. S. Ms

**Padmabhooshan Vasatraodada Patil Institute of Technology
Budhagaon**

CERTIFICATE

This is to certify that the mini project entitled

JFET Amplifier and Frequency Response

Is partial fulfillment for the award of Bachelor of Electronics and Telecommunication Engineering, as laid down by Dr. Babasaheb Ambedkar Technological University Lonere, during academic year 2022-23. It is bonafied record of Mini project carried out by

Chandrika V. Shetty

PRN No-2162691372526

Bhakti S. Hanamane

PRN No-2162691372516

Aishwarya S. Muchandi

PRN No-2062691612005



Prof. D. O. Shirsath

Guide



Prof. R. S. More.



Dr. M. S. Chavan.

HOD

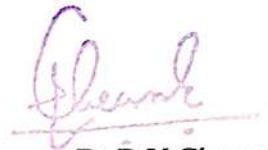

Dr. D. V. Ghewade

Principal

Dr.V. P. S. S. Ms.

**Padmabhooshan Vasantodada Patil Institute of
Technology, Budhgaon.**

CERTIFICATE

This is to certify that the seminar entitled –

Envelope Diode Detector

is partial fulfillment for the award of Bachelor of Electronics and telecommunication Engineering , as laid down by Dr. Babasaheb Ambedkar Technological University, Lonere ,during academic year 2022-23. It is bonafied record of seminar carried out by-

Ms. Tejashree Shashikant Patil. (PRN No. -E2162691372524) (Roll No.-68).



(Prof. R. S. More)

(Prof. D. O. Shirsath)

Guide

(Dr. M.S. Chavan)

HOD

(Dr. D. V. Ghewade)

Principal

PADMABHOOSHAN VASANTRAODADA PATIL
INSTITUTE OF TECHNOLOGY, BUDHGAON
(SANGLI).
YEAR 2022-2023

CERTIFICATE



This is to certify that the Mini Project report entitled
"LM337 Negative Voltage Regulator"

Submitted By

Sr. No.	NAME	ROLL NO.
1	SHREYASH D. PATIL	3103
2	OMKAR S. BHENKI	3112
3	VAIBHAV A. PUJARI	3109

is a record of the work done during the academic year 2022-2023 of B-Tech Degree in
ELECTRONIC AND TELECOMMUNICATION ENGINEERING of Padmabhooshan
Vasanttraodada Patil Institute of Technology has be carried out by him under our guidance ,as an
internal guide, satisfactorily.

Place: Budhgaon

Date:

Prof. D.O. Shirsath & Prof. C. M. Patil

(GUIDE)

Dr. M. S. Chavan

(H.O.D.)

Dr. D. V. Ghewade

(PRINCIPAL)

PADMABHOOSHAN VASANTRAODADA PATIL
INSTITUTE OF TECHNOLOGY, BUDHGAON
(SANGLI).
YEAR 2022-2023

CERTIFICATE



This is to certify that the Mini Project report entitled
"LM337 Negative Voltage Regulator "

Submitted By

Sr. No.	NAME	ROLL NO.
1	SHREYASH D. PATIL	3103
2	OMKAR S. BHENKI	3112
3	VAIBHAV A. PUJARI	3109

is a record of the work done during the academic year 2022-2023 of B-Tech Degree in ELECTRONIC AND TELECOMMUNICATION ENGINEERING of Padmabhooshan Vasanttraodada Patil Institute of Technology has be carried out by him under our guidance ,as an internal guide, satisfactorily.

Place: Budhgaon

Date:

Prof. D.O. Shirsath & Prof. C. M. Patil

(GUIDE)

Dr. M. S. Chavan

(H.O.D.)

Dr. D. V. Ghewade

(PRINCIPAL)

Dr. V.P.S.S.M's
PADMABHOOSHAN VASANTRAODADA PATIL
INSTITUTE OF TECHNOLOGY, BUDHGAON
(SANGLI).
YEAR 2022-2023

CERTIFICATE



This is to certify that the Mini Project report entitled
"DESIGN A CLASS B POWER AMPLIFIERS "

Submitted By

Sr. No.	NAME	ROLL NO.
1	vaishanavi A. patil	3123
2	vaishanavi P. Khandekar	3124
3	komal S. Nikam	3126

is a record of the work done during the academic year 2022-2023 of B-Tech Degree in
ELECTRONIC AND TELECOMMUNICATION ENGINEERING of Padmabhooshan
Vasanttraodada Patil Institute of Technology has be carried out by him under our guidance ,as an
internal guide, satisfactorily.

Place: Budhgaon

Date:

Prof. D.O. Shirsath & Prof. C. M. Patil
(GUIDE)

Dr. M. S. Chavan
(H.O.D.)

Dr. D. V. Ghewade
(PRINCIPAL)

Dr. V. P.S. S. Ms

Padmabhooshan Vasantrodada Patil Institute of Technology
Budhagaon

CERTIFICATE

This is to certify that the mini project entitled

JFET CHARACTERISTIC

Is partial fulfillment for the award of Bachelor of Electronics and Telecommunication Engineering, as laid down by Dr. Babasaheb Ambedkar Technological University Lonere, during academic year 2022-23. It is bonafied record of Mini project carried out by

Samarth Sudhir Pawar.
Prathamesh Santosh Patil.
Prajwal Vitthal Wankhande.

PRN No-2062691376006
PRN No-2062691372013
PRN No-2062191372513



Prof. D. O. Shirsath

Guide



Prof. R. S. More.



Dr. M. S. Chavan.

HOD



Dr. D. V. Ghewade

Principal

Dr. V.P.S.S.M's
PADMABHOOSHAN VASANTRAODADA PATIL
INSTITUTE OF TECHNOLOGY, BUDHGAON
(SANGLI).
YEAR 2022-2023

CERTIFICATE



This is to certify that the Mini Project report entitled
"DESIGN A CLASS AB POWER AMPLIFIERS "

Submitted By

Sr. No.	NAME	ROLL NO.
1	SIMRAN S. MULLA	3107
2	POONAM U. BHORE	3114
3	MONALI V. GURAV	3117

is a record of the work done during the academic year 2022-2023 of B-Tech Degree in ELECTRONIC AND TELECOMMUNICATION ENGINEERING of Padmabhooshan Vasantraodada Patil Institute of Technology has be carried out by him under our guidance ,as an internal guide, satisfactorily.

Place: Budhgaon

Date:

Prof. D.O. Shirsath & Prof. C. M. Patil
(GUIDE)

Dr. M. S. Chavan
(H.O.D.)

Dr. D. V. Ghewade
(PRINCIPAL)

**PADMABHOOSHAN VASANTRAODADA PATIL
INSTITUTE OF TECHNOLOGY, BUDHGAON
(SANGLI).
YEAR 2022-2023**

CERTIFICATE



This is to certify that the Mini Project report entitled
"LM337 Negative Voltage Regulator "

Submitted By

Sr. No.	NAME	ROLL NO.
1	CHINMAYEE S. JOSHI	3157
2	MANSI S. JADHAV	3158
3	AFRIN I. MULANI	3160

is a record of the work done during the academic year 2022-2023 of B-Tech Degree in ELECTRONIC AND TELECOMMUNICATION ENGINEERING of Padmabhooshan Vasanttraodada Patil Institute of Technology has been carried out by him under our guidance, as an internal guide, satisfactorily.

Place: Budhgaon

Date:

Prof. D.O. Shirsath & Prof. R.S. More
(GUIDE)

Dr. M. S. Chavan
(H.O.D.)

Dr. D.V. Ghewade
(PRINCIPAL)

Dr. V.P.S.S.M's
PADMABHOOSHAN VASANTRAODADA PATIL
INSTITUTE OF TECHNOLOGY, BUDHGAON
(SANGLI).
YEAR 2022-2023

CERTIFICATE



This is to certify that the Mini Project report entitled
“**Transfer Characteristics of MOSFET**”

Submitted by

Chaitanya A. Inamdar	3161
Prathmesh S. Paranjape	3165
Snehal S. Kokane	3169

is a record of the work done during the academic year 2022-2023 of B-Tech Degree in ELECTRONIC AND TELECOMMUNICATION ENGINEERING of Padmabhooshan Vasanttraodada Patil Institute of Technology has been carried out by him under our guidance, as an internal guide, satisfactorily.

Place: Budhgaon

Date:

Prof. D.O. Shirsath & Prof. R.S. More
(GUIDE)

Dr. M. S. Chavan
(H.O.D.)

Dr. D. V. Ghewade
(PRINCIPAL)

Dr.V.P.S.S.M's
PADMABHOOSHAN VASANTRAODADA PATIL
INSTITUTE OF TECHNOLOGY, BUDHGAON
(SANGLI).
YEAR 2022-2023

CERTIFICATE



This is to certify that the Mini Project report entitled
“ JFET Amplifier”

Submitted by

Shivraj D. Patil	3162
Shivaram A. Babar	3163
Siddhanath P. Valukar	3164

is a record of the work done during the academic year 2022-2023 of B-Tech Degree in
ELECTRONIC AND TELECOMMUNICATION ENGINEERING of Padmabhooshan
Vasanttraodada Patil Institute of Technology has be carried out by him under our guidance ,as an
internal guide, satisfactorily.

Place: Budhgaon

Date:

Prof. D.O. Shirsath & Prof. R.S. More
(GUIDE)

Dr. M. S. Chavan
(H.O.D.)

Dr. D. V. Ghewade
(PRINCIPAL)

Dr. V. P. S. S. Ms

Padmabhooshan Vasantrodada Patil Institute of Technology, Budhagaon

CERTIFICATE

This is to certify that the project report entitled

Class A Power Amplifier

Is partial fulfillment for the award of Bachelor of Electronics and Telecommunication Engineering, as laid down by Dr. Babasaheb Ambedkar Technology University Lonere, during academic year 2022-23. It is bonafied record of project report carried out by

Minal Vijaykumar Mali.

PRN No-2162691372501

Seema Pandurang Shinde.

PRN No-2162691372509

Shrutika Yashvant Bhendvade.

PRN No-2162691372508

Prof. D.O. Shirsath

(Guide)

Prof. C.M. Patil

Dr. M.S. Chavan

(HOD)

Dr. D.V. Ghewade

(Principal)

Dr. V.P.S.S.M's

PADMABHOOSHAN VASANTRAODADA PATIL
INSTITUTE OF TECHNOLOGY, BUDHGAON
(SANGLI).

YEAR 2022-2023

CERTIFICATE



This is to certify that the Mini Project report entitled
"CURRENT SHUNT AMPLIFIER "

Submitted By

Sr. No.	NAME	ROLL NO.
1	SAKSHI. L. KARALE	3101
2	SHILPA .B.PATIL	3116

is a record of the work done during the academic year 2022-2023 of B-Tech Degree in ELECTRONIC AND TELECOMMUNICATION ENGINEERING of Padmabhooshan Vasanttraodada Patil Institute of Technology has be carried out by him under our guidance ,as an internal guide, satisfactorily.

Place: Budhgaon

Date:

Prof. D. O. Shirsath &

Prof. C. M. Patil

(GUIDE)

Dr. M. S. Chavan

(H.O.D.)

Dr. D.V.Ghewade

(Principal)

Dr. V. P. S. S. Ms

Padmabhooshan Vasantodada Patil Institute of Technology,
Budhgaon



CERTIFICATE

This is to certify that the mini-project entitled

SECURITY ALARM SYSTEM

is partial fulfillment for the award of Bachelor of Electronics and Telecommunication Engineering, as laid down by Dr. Babasaheb Ambedkar Technological University, Lonere, during academic year 2022-23. It is bonafide record of mini-project carried out by

Mukteshwari Rahul Mirge



PRN- 2062691372008

Neha Nitin Arwade

PRN- 2062691372009

Vedant Shashikant Shevate

PRN- 2062691372037

Guide

(Prof. D. O. Shirsath & Prof. C. M. Patil)

HOD
(Dr. M. S. Chavan)

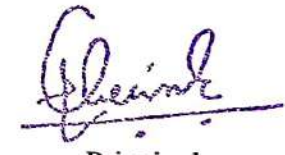
Principal
(Dr. D. V. Ghewade)

Dr.V.P.S.S.M's
PADMABHOOSHAN VASANTRAODADA PATIL
INSTITUTE OF TECHNOLOGY, BUDHGAON
(SANGLI).
YEAR 2022-2023

CERTIFICATE



This is to certify that the Mini Project report entitled
“MOSFET Amplifier”

Submitted By

Sr. No.	NAME	ROLL NO.
1	VAIBHAV D. PATIL	3104
2	ANIKET K. WAGHMODE	3111
3	SAURABH S. SHINDE	3115

is a record of the work done during the academic year 2022-2023 of B-Tech Degree in ELECTRONIC AND TELECOMMUNICATION ENGINEERING of Padmabhooshan Vasantraodada Patil Institute of Technology has be carried out by him under our guidance ,as an internal guide, satisfactorily.

Place: Budhgaon.

Date:-

Prof.D.O.Shirsath & Prof.C.M.Patil
(GUIDE)

Dr.M.S.Chavan
(HOD)

Dr.D.V.Ghewade
(PRINCIPLE)

Dr.V.P.S.S.M's
PADMABHOOSHAN VASANTRAODADA PATIL
INSTITUTE OF TECHNOLOGY, BUDHGAON
(SANGLI).
YEAR 2022-2023

CERTIFICATE



This is to certify that the Mini Project report entitled
"LM317 Voltage Regulator "

Submitted By

Sr. No.	NAME	ROLL NO.
1	Avadhoot .V. Kheradkar	3105
2	Virendra .S. Desai	3108
3	Sangram .S. Patil	3118

is a record of the work done during the academic year 2022-2023 of B-Tech Degree in ELECTRONIC AND TELECOMMUNICATION ENGINEERING of Padmabhooshan Vasanttraodada Patil Institute of Technology has be carried out by him under our guidance ,as an internal guide, satisfactorily.

Place: Budhgaon

Date:

Prof. D.O. Shirsath & Prof. C. M. Patil
(GUIDE)

Dr. M. S. Chavan
(H.O.D.)

Dr. D. V. Ghewade
(PRINCIPAL)

INSTITUTE OF TECHNOLOGY, BUDHGAON
(SANGLI).
YEAR 2022-2023

CERTIFICATE



This is to certify that the Mini Project report entitled
“ **MOSFET Characteristics** ”

Submitted By

Sr. No.	NAME	ROLL NO.
1	OM ASHOKBHAI SHINDE	3113

is a record of the work done during the academic year 2022-2023 of B-Tech Degree in
ELECTRONIC AND TELECOMMUNICATION ENGINEERING of Padmabhooshan
Vasanttraodada Patil Institute of Technology has be carried out by him under our guidance ,as an
internal guide, satisfactorily.

Place: Budhgaon
Date:

Prof. D.O. Shirsath & Prof. C. M. Patil
(GUIDE)

Dr. M. S. Chavan
(H.O.D.)

Dr. D.V. Ghewade
(PRINCIPAL)

Dr. V. P. S. S. Ms

Padmabhooshan Vasanttraodada Patil Institute of Technology Budhgaon

CERTIFICATE

**This is to certify that the Mini-project entitled
[ADJUSTABLE VOLTAGE REGULATOR]**

Is partial fulfillment for the award of Bachelor of Electronics and Telecommunication Engineering, as laid down by Dr. Babasaheb Ambedkar Technological University, Lonere, during academic year 2022- 23 . It is bonafied Record of Mini-project carried out by

Name - Prajakta Sunil Narute (3155)

Sign -

Vaishnavi Sanjay Patil (3159)

Sign -

Anuradha Appasaheb Koli (3166)

Sign -

Guide

(Prof. D.O. Shirsath)

(Prof.R.S.More)

HOD

(Dr.M.S.Chavan)

Principal

(Dr.D.V.Ghewade)

Dr. V. P.S. S. Ms

PadmabhooshanVasatraodadaPatil Institute of Technology ,Budhgaon

CERTIFICATE

This is to certify that the mini project entitled

MOSFET AMPLIFIER

Is partial fulfillment for the award of Bachelor of Electronics and Telecommunication Engineering, as laid down by Dr. Babasaheb Ambedkar Technological University Lonere, during academic year 2022-23.It is bonafied record of Mini project carried out

Prajakta Venkatesh Kale.PRN NO-2062691372036 3150

Ankshumi AmolPatil.PRN No-2062191372005 3147

Prajakta Pralhad Shinde.PRN No-2062191372012 3149



Prof. D. O. Shirsath

Guide



Prof. R. S. More.



Dr. M. S. Chavan.

HOD



Dr. D. V. Ghewade

Principal

CERTIFICATE



This is to certify that the Mini Project report entitled
“Colpitts Oscillators”

Submitted By

- 1) Vaishnavi Mane – 2062691372024
- 2) Vaishnavi chandurkar -2162691372523
- 3) Shubhada Kulkarni -2062691372020
- 4) Sharvree Chougale – 2162691372503

is a record of the work done during the academic year 2022-2023 of B-Tech Degree in ELECTRONIC AND TELECOMMUNICATION ENGINEERING of Padmabhooshan Vasanttraodada Patil Institute of Technology has been carried out by him under our guidance, as an internal guide, satisfactorily.

Place: Budhgaon

Date: 24 | 12 | 2022

Prof. D.O. Shirsath & Prof. R.S. More
(GUIDE)

Dr. M. S. Chavan
(H.O.D.)

Dr. D.V. Ghewade
(PRINCIPAL)

Academic Year :- 2022-23

Dr. V. P. S. S. M.'s
**Padmabhooshan Vasantraodada Patil Institute of
Technology, Budhgaon Sangli**



Certificate

"Smart street light"

This is to Certify that, above project work is carried out in Department of Electronics and telecommunications Engineering by

Karan Chandrakant Pawar **2062691372007**

Soham Suryakant jadhav **2062691372031**

In partial fulfilment of requirement as a part of syllabus by **Dr.**
Babasaheb Ambedkar Technological University, Lonere for the course **T. Y.**
B. Tech. during the academic year **2022-23** under my guidance

Guide
Prof. D. O. Shirsath
Prof. C. M. Patil.

HOD
Dr. M. S. Chauhan

Principal
Dr. D. V. Ghewade.

Dr. V. P. S. S. MS
P. V. P. Institute of Technology Budhagaon
Department of Electronics and Telecommunication
Year 2022-2023

CERTIFICATE

This is to certify that the Mini Project report entitled

“Temperature Controlled Fan”

Submitted By

Sr. No.	Name	Roll No.	PRN No.
1	Sahil Mahamad Nadaf	3132	2062691372015
2	Om Suhas Sankapal	3135	2062691372010

Is a record of the work done during the academic year 2022-2023 of B.Tech. Degree in ELECTRONIC AND TELECOMMUNICATION ENGINEERING of Padmabooshan Vasantrodada Patil Institute of Technology has be carried out by him under our guidance, as an internal guide, satisfactorily.

Place: Budhgaon

Date:

 Guide
(Prof. C. M. Patil & Prof. D. O. Shirsath)

HOD
(Dr. M. S. Chavan)

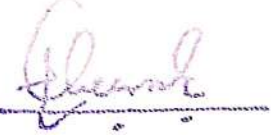
Principal
(Dr. D. V. Ghewade)

Dr. V. P. S. S. Ms

Padmabhooshan Vasanthaodada Patil Institute of Technology
Budhgaon

CERTIFICATE

This is to certify that the Mini project entitled

[VARIOMETER]

It gives us immense pleasure to present a report on the successful completion of our Mini project on "VARIOMETER". We express our sense of gratitude to our guides **Prof. D. O. Shirsath & Prof. C. M. Patil** for their valuable guidance. We are thankful for their hearted assistance, advice and expert guidance towards making our report successful. Our special thanks to the honorable Principal **Dr. D. V. Ghewade** & Head of Department **Dr. M. S. Chavan** for their keen interest, encouragement and excellent support.

Name - Aniket J. Mohite

PRN No. - (2162691372004)

Sagar S. Pawar

PRN No. - (2162691372014)

Shuhbam c. Gurav

PRN No. - (2162691372021)

 
Guide

Prof. D.O. Shirsath
Prof. C.M. Patil

HOD

Dr. M. S. Chavan



Principal

Dr. D. V. Ghewade

Dr.V.P.S.S.M's
PADMABHOOSHAN VASANTRAODADA PATIL
INSTITUTE OF TECHNOLOGY, BUDHGAON
(SANGLI).
YEAR 2022-2023

CERTIFICATE



This is to certify that the Mini Project report entitled
“**RC Phase Shift Oscillator**”

Submitted By

Sr. No.	NAME	ROLL NO..
1	Sakshi Nandkumar Mahajan	3119
2	Manali Baburao Hakke	3122
3	Sakshi Vidyasagar Shedbalkar	3156

is a record of the work done during the academic year 2022-2023 of B-Tech Degree in ELECTRONIC AND TELECOMMUNICATION ENGINEERING of Padmabhooshan Vasantraodada Patil Institute of Technology has be carried out by him under our guidance ,as an internal guide, satisfactorily.

Place: Budhgaon

Date-

Prof.D.Shirsat & Prof.C.M.Patil

(GUIDE)

Dr.M.S.Chavan

(H.O.D.)

Dr.D.V.Ghewade

(PRINCIPLE)

Dr. V.P.S.S.Ms

Padmabhooshan Vasantraodada Patil Institute of Technology, Budhagoan

CERTIFICATE



this is to certify that the project report entitled

“UJT RELAXATION OSCILLATOR”

Is partial fulfilment for the award of Bachelor of Electronics and Telecommunication Engineering, as laid down by Dr. Babasaheb Ambedker Technology University Lonere, during academic year 2021-22. It is bonafied record of project carried out by

Vaishnavi. S. Suryavanshi

PRN- 2062691372038

Akshata. M. Chavan

PRN- 2162691372515

Prajakta. R. Patil

PRN- 2162691372514

Prof.D.O.Shirsath Prof.C.M.Patil

(Guide)

Dr.M.S.Chavan

(HOD)

Dr.D.V.Ghewade

(Principal)

Internship Details
A.Y:- 2022-23
Class:- B.Tech (Electronics)

Sr No	Name of Student	Training Details	Duration
1	ARSHIYA AYUB SHAIKH	Training on " Imagine processsing using OpenCv" by Pantech E-learning	12/10/2022-11/11/2022
3	SHAGUFTA IRSHADAHMAD NADAF	Training on " Imagine processsing using OpenCv" by Pantech E-learning	12/10/2022-11/11/2022
4	TUSHAR VASANT VHANMANE	Training on " Imagine processsing using OpenCv" by Pantech E-learning	12/10/2022-11/11/2022
5	VIDYA RAJU SAGARE	Training on " Imagine processsing using OpenCv" by Pantech E-learning	12/10/2022-11/11/2022
6	ROHANSAI VIJAYKUMAR KOSURI	Training on " Imagine processsing using OpenCv" by Pantech E-learning	12/10/2022-11/11/2022
7	AARTI AJIT MAHADIK	Training on " Imagine processsing using OpenCv" by Pantech E-learning	12/10/2022-11/11/2022
8	JANAKI SHARAD JAMBHALIKAR	Training on " Imagine processsing using OpenCv" by Pantech E-learning	12/10/2022-11/11/2022
9	SANDILI BANDU BHOSALE	Training on " Imagine processsing using OpenCv" by Pantech E-learning	12/10/2022-11/11/2022
10	AISHWARYA PAYAGONDA PATIL	Training on " Power Electronics Devices and circuits" by Infinity Electrical Madhavnagar	10/10/2022-10/11/2022
11	NISHA BALASAHEB PATIL	Training on " Imagine processsing using OpenCv" by Pantech E-learning	12/10/2022-11/11/2022
12	RUTUJA VISHWASRAO PATIL	Training on " Imagine processsing using OpenCv" by Pantech E-learning	12/10/2022-11/11/2022
13	SAKSHI PURUSHOTTAM DONGARE	Training on" Power Electronics Devices and circuits" by Infinity Electrical Madhavnagar	10/10/2022-10/11/2022
14	IMTIYAJ HANIF SHAIKH	Training on " Imagine processsing using OpenCv" by Pantech E-learning	12/10/2022-11/11/2022
15	VAISHNAVI MILIND CHOUGULE	Training on " Imagine processsing using OpenCv" by Pantech E-learning	12/10/2022-11/11/2022
16	PRAJVAL VILAS SHINDE	Training on " Imagine processsing using OpenCv" by Pantech E-learning	12/10/2022-11/11/2022
17	PRATIK PANDURANG PATIL	Training on" Power Electronics Devices and circuits" by Infinity Electrical Madhavnagar	10/10/2022-10/11/2022
18	SHIVRAJ ANANDSINH RAJPUT	Training on " Imagine processsing using OpenCv" by Pantech E-learning	12/10/2022-11/11/2022
19	MILIND HANMANT LINGE	Training on" Power Electronics Devices and circuits" by Infinity Electrical Madhavnagar	15/09/2022-15/10/2022
20	VARAD PRASHANT CHIVATE	Training on " Imagine processsing using OpenCv" by Pantech E-learning	12/10/2022-11/11/2022
21	HARSHAD CHAVAN	Training on" Power Electronics Devices and circuits" by Infinity Electrical Madhavnagar	10/10/2022-10/11/2022
22	PRDNYA UBALE	Training on " Imagine processsing using OpenCv" by Pantech E-learning	12/10/2022-11/11/2022

HOD
 (Dept. of ELN Engg)



Principal
 Padmabhooshan Vasantrodada Patil
 Institute of Technology
 BUDHGAON - 416 304

Internship Details
A.Y:- 2022-23
Class:- T.Y(Electronics)

Sr No	Name of Student	Training Details	Duration
1	NUMAN ZAKIRHUSEN SHAIKH	Training on " Data structure and Object Oriented Programming" by Aptech Campus Recruitment Training	13/10/2022-13/11/2022
2	SHARWARI SANJAY GAIKWAD	Training on " C programming" by Gomtesh Computer Institute	10/11/2022-15/12/2022
3	SHIVANI SHIVALING SANKPAL	Training on " Data structure and Object Oriented Programming" by Aptech Campus Recruitment Training	13/10/2022-13/11/2022
4	AJAY KHANDU KUMBHAR	Training on " C programming" by Gomtesh Computer Institute	26/09/2022-31/10/2022
5	VIGHNARAJ DINKAR MOHITE	Training on " C programming" by Gomtesh Computer Institute	26/09/2022-31/10/2022
6	VRUSHALI SUBHASH GODASE	Training on "C programming" by Aditya InfoTech , Sangli	26/09/2022-31/10/2022
7	SHIVRATNA RAMCHANDRA PATIL	Training on n" Python programming" by Tecspeak IT solutioins	9/8/2022-17/9/2022
8	KOMAL SANDEEP PATIL	Training on " Data structure and Object Oriented Programming" by Aptech Campus Recruitment Training	13/10/2022-13/11/2022
9	YASH RAMESH CHAVAN	Training on " Data structure and Object Oriented Programming" by Aptech Campus Recruitment Training	
10	SHRADDHA SANDEEP DESHMUKH	Training on Weighting Machine manufacturing at Electro India	01/11/2022-30/11/2022
11	ANJALI PANDIT MOHITE	Training on " Data structure and Object Oriented Programming" by	14/10/22-14/11/2022
12	ADITYA SUDHIR WAGHMARE	Training on "Core JAva" by Aditya InfoTech , Sangli	11/9/2022-15/11/2022
13	HARSHAVARDHAN ARWIND SAVANT	Training on " Data structure and Object Oriented Programming" by Aptech Campus Recruitment Training	14/10/22-14/11/2022
14	PRAJYOT PRASHANT SATHAYE	Training on" Machine Learning for beginers" by SimpleLearn	01/11/2022-20/12/2022
15	ADITI NARAYAN ABHYANKAR	Training on " Data structure and Object Oriented Programming" by Aptech Campus Recruitment Training	14/10/22-14/11/2022

16	OM MILIND DHAMANAGE	Training on "Core Java" by Aditya InfoTech , Sangli	11/9/2022-15/11/2022
17	SUHANA MAHAMUD MAGDUM	Training on " Data structure and Object Oriented Programming" by Aptech Campus Recruitment Training	14/10/22-14/11/2022
18	DHIRAJ MANIK PAWAR	Training on "Python Programming " by Pregrand Skills	15/11/2022-18/02/2023
19	PRATIK ASHOK SADARE	Training on" Basic of C" by learnTube.ai	10/08/2022-15/09/2022
20	PRAMOD ABHAY ALATE	Training on "Core JAva" by Aditya InfoTech , Sangli	11/9/2022-15/11/2022
21	RUSHIKESH ASHOK KADAM	training on "Java Algorithms" by grate learning	01/12/2022-1/1/2023
22	VAIBHAV PRAKASH VIBHUTE	Training on " Data structure and Object Oriented Programming" by Aptech Campus Recruitment Training	13/10/2022-14/11/2022
23	SHRADDHA RAVASO CHOUGULE	Training on " Data structure and Object Oriented Programming" by Aptech Campus Recruitment Training	14/9/2022-14/10/2022
24	APURV ATUL KHARADE	training on "data Structure in C" at Greatlearning	15/12/2022-15/01/2023
25	PRATIKSHA SURESH PAWAR	Training on " Data structure and Object Oriented Programming" by	14/10/22-14/11/2022
26	UZMA MIYALAL KHATIB	Training on " Python Programming " on Great learning	
27	SUPRIYA GURAPPA MHETRE	Training on " Data structure and Object Oriented Programming" by	14/10/22-14/11/2022
28	SHWETA SHIVAJI PATIL	Training on " Data structure and Object Oriented Programming" by Aptech Campus Recruitment Training	14/10/22-14/11/2022
29	SNEHA DADASO SHINDE	Training on "C++ programming" by Intershala	16/11/2022-15/12/2022
30	GITANJALEE SITARAM GURAV	Training on " Data structure and Object Oriented Programming" by Aptech Campus Recruitment Training	14/10/22-14/11/2022
31	AKASH HARI KOLEKAR	Training on " Data structure and Object Oriented Programming" by Aptech Campus Recruitment Training	01/10/2022-1/11/2022
32	SIDDHARTH BALASAHEB KAMBLE	Training on " Data structure and Object Oriented Programming" by Aptech Campus Recruitment Training	01/10/2022-1/11/2022
33	PRANJALI DATTATRAY GAVADE	Training on " Data structure and Object Oriented Programming" by	14/10/22-14/11/2022
34	MONIKA SHRIKANT MANE	Training on " Data structure and Object Oriented Programming" by Aptech Campus Recruitment Training	02/10/2022-05/11/2022
35	NILESH NAYAN KULKARNI	Training on Weighting Machine manufacturing at Electro India	01/11/2022-30/11/2022
36	SARFARAJ MUSTAK PATHAN	Training on "C++ programming" by Intershala	31/10/2022-15/12/2022
37	PRANALI VISHWAS DEVKULE	Training on " Data structure and Object Oriented Programming" by	14/10/22-14/11/2022

38	VIDYA RAMKRISHNA PATIL	Training on " Data structure and Object Oriented Programming" by Aptech Campus Recruitment Training	14/10/22-14/11/2022
39	ADITYA RAJENDRA PATIL	Training on " Data structure and Object Oriented Programming" by Aptech Campus Recruitment Training	01/10/2022-1/11/2022
40	JAINAB FIROZ PINJARI	Training on " Data structure and Object Oriented Programming" by	14/10/22-14/11/2022
41	SHRUTI DAYANAND TASGAONKER	Training on " Andriod Applocation Development" by Great Learning	
42	SNEHAL UDAY MALI	Training on " Andriod Applocation Development" by Great Learning	
43	SRUSHTI BASAVRAJ PACHHAPURE	Training on " Data structure and Object Oriented Programming" by Aptech Campus Recruitment Training	13/10/2022-13/11/2022
44	ABHIJEET BAPU HUBALE	Training on Weighting Machine manufacturing at Electro India	01/11/2022-30/11/2022
45	SHUBHAM SAMBHAJI KADAM	Training on " C programming" by Gomtesh Computer Institute	26/09/2022-31/10/2022
46	DIVYA ARUN IRALE	Training on Weighting Machine manufacturing at Electro India	01/11/2022-30/11/2022
47	HARSHWARDHAN YASHWANT CHOUGALE	Training on " Andriod Applocation Development" by Great Learning	
48	PRUTHVIRAJ CHANDRAKANT MANE	Training on Weighting Machine manufacturing at Electro India	01/11/2022-30/11/2022
49	AKSHAY PANDURANG PAWAR	Training on " AI and big data in IoT" by Graeatlearning	20/12/2022-17/01/2023
50	PRATHAMESH SUNIL PARIT	Training on Weighting Machine manufacturing at Electro India	01/11/2022-30/11/2022

HOD
 (Dept. of ELN Engg)

Principal
 Padmabhooshan Vasantodada Patil
 Institute of Technology
 BUDHGAON - 416 304

Internship Details
A.Y:- 2022-23
Class:- B.Tech (Electronics)

Sr No	Name of Student	Training Details	Duration
1	ARYAN NITIN MANE	Training on " weighting machine Manufacturing" at Electro India Sangli	4/5/2022-5/6/2022
2	RUTUJA SANJAY MALI	Training on" C and C++ Programming " by Intershala	08/01/2023-05/03/2023
3	SNEHAL MAHESH PAWAR	Training on" C and C++ Programming " by Intershala	12/10/2022-11/11/2022
4	ARSHAD UMAR SHAIKH	Training on Capacitors at Magnewin Energy Pvt LTD, Sangli	4/05/2022-5/6/2022
5	GURUPRASAD SURESH PUJARI	Training on Capacitors at Magnewin Energy Pvt LTD, Sangli	4/05/2022-5/6/2022
6	ABHAY GAJANAN NANGARE	Training on " Networking and cloud Services" at Domain Computers	4/5/2022-14/2/2022
7	PAYAL SANJAY BHOSALE	Training on " Internet Fundamentals,HTML,CSS, JAVA script" at Aditya Infotech	1/10/2022-19/11/2022
8	SANIKA UTTAM LAD	Training on" HTML,CSS, Javascript" at Aditya Infotech Sangli	1/10/2022-19/11/2022
9	ANISHA AJIT SHINDE	Training on " Cloud computing and Networking" by Domain Computers , Sangli	10/10/2022-22/11/2022
10	VIDYA DILIP MADANE	Training on" C and C++ Programming " by Intershala	08/01/2023-05/03/2023
11	ANKITA VILAS MADANE	Training on" C and C++ Programming " by Intershala	08/01/2023-05/03/2023
12	SANIVANI BHIMRAV MADANE	Training on" C and C++ Programming " by Intershala	08/01/2023-05/03/2023
13	SIDDHARTH SUNIL VADGAONKAR	Training on " Cloud computing and Networking" by Domain Computers , Sangli	10/10/2022-22/11/2022
14	NIRANJAN UDAY PATIL	Training on "C Programming " at Shatrunjay Institute, Sangli	3/1/2023-17/2/2023
15	SWAPNIL SUNIL MALI	Training on " C programming" at Boston Computer Institute , Sangli	3/1/2023-17/2/2023
16	VISHWAJEET NANASO CHAVAN	Training on " Control Pannel Testing " by ICON Industry	20/10/2022-30/11/2022
17	SHRAWANI SANJAYKUMAR NIKAM	Training on" Python Programming" by Intershala	25/1/2023-4/3/2023
18	RUSHIKESH ANANDA KOLAPE	Training on " C programming" at Boston Computer Institute , Sangli	17/1/2023-17/2/2023
19	PRATHMESH VASANTRAO PATIL	Training on " Transformer" at Khare electronics Tasgaon	28/1/2023-18/2/2023
20	ATUL SUHAS PATIL	Training on " HTML,CSS, JAVA script" at Aditya Infotech	1/10/2022-19/11/2022
21	PRATIK VIJAY JADHAV	Training on " C programming " by Digital Adda	15/12/2022-21/1/23
22	VRUSHABH SHANTINATH MULE	Training on " Networking and cloud Services" at Domain Computers	10/1/2022-22/11/2022
23	ATHARVA AVINASH BIDKAR	Training on " Networking and cloud Services" at Domain Computers	12/12/2022-31/01/2023
24	SHREYA RAHUL YADAV	Training on "Hardware, software , Networking and cloud Services" at Domain Computers	12/12/2022-31/1/2023
25	SHRUTI PRASHANT GURAV	Training on " C programming" at Shatrunjay , Sangli	2/12/2022-15/1/2023
26	PAJAJAL RAMESH MAHARNUR	Training on " Networking and cloud Services" at Domain Computers	12/12/2022-31/1/2023
27	PAJAJAL DILIP PATIL	Training on " weighting machine Manufacturing" at Electro India Sangli	3/1/2023-3/2/2023
28	AAKASH CHANDRAKANT MULIK	Training on " C programming" at Boston Computer Institute , Sangli	1/1/2023-15/2/2023
29	PRANAV SHAHAJI MOHITE	Training on " C programming" at Boston Computer Institute , Sangli	1/1/2023-17/2/2023
30	KARAN SANJAY KOLI	Training on " Networking and cloud Services" at Domain Computers	12/12/2022-31/1/23
31	MAITHILI SANTOSH PATIL	training on" web technology, C, C++" by Movinture	15/5/2022-15/06/2022
32	DHANARAJ SHIDHU BALLOLE	Training on " C programming" at Boston Computer Institute , Sangli	3/1/2023-17/2/2023
33	SHRIYATA DINKAR CHAVAN	Training on" Python Programming" on Greate Learning	1/2/2023-20/2/2023
34	PRATIKSHA PRAMOD SALE	Training on " C and C++ Programming" at Intershala	12/10/2022-11/11/2022
35	AKANKSHA ANANDARAO JAGDALE	Training on " Dairy software" at Shiv Traders Sangli	00/05/2022-00/06/2022
36	PRAGATI CHANDRAKANT KAMBLE	Training on " Networking and cloud Services" at Domain Computers	20/1/2023-26/2/2023
37	SEJAL NAMDEV PAWAR	Training on "C Programming " at Shatrunjay Institute, Sangli	2/12/2022-15/1/2023
38	SHREYA ANIL PATIL	Training on "C Programming " at Shatrunjay Institute, Sangli	2/12/2022-15/1/2023
39	SANKET SHIVAJI KATAKAR	Training on" Python Programming" on Greate Learning	1/2/2023-20/2/2023
40	ROHIT DHANAJI CHAVAN	Training on "C Programming " at Yash Aradhya	1/1/2023-15/2/2023
41	HARSHADA PRAMOD PATIL	Training on " C and C++ Programming" at Intershala	08/01/2023-05/03/2023
42	VISHWARAJ RAJENDRA PATIL	Training on " C and C++ Programming" at Intershala	08/01/2023-05/03/2023
43	SHRADDHA SANJAY CHOUGULE	Training on " C programming" at Pranam Computers Sangli	1/12/2022-31/12/2022
44	RUSHIKESH BALASO MIRAJE	Training on " Arduino " at Intershala	24/12/2022-27/01/2023
45	SANIKA PRASHANT LIMAYE	Training on" Python Programming" at Intershala	25/1/2023-4/3/2023
46	PRATHAMESH ADHIK MANE	Training on " Hardware,software ,Networking and cloud Services" at Domain Computers	10/10/2022-22/11/2022
47	BHAGYASHREE DINKAR SHINDE	Training on " weighting machine Manufacturing" at Electro India Sangli	3/1/2023-3/2/2023

48	SHUBHAM SIDU NANGARE	Training on "C Programming" at Shatrunjay Institute, Sangli	3/1/2023-17/2/2023
49	PARSHWA VINOD PATIL	Training on Capacitors at Magnewin Energy Pvt LTD, Sangli	4/5/2022-5/6/2022
50	SANIKA MANGESH PATIL	Training on " weighting machine Manufacturing" at Electro India Sangli	3/1/2023-3/2/2023
51	SOHAM SANMATIKUMAR BAGEWADE	Training on " C programming" at Boston Computer Institute , Sangli	3/1/2023-17/2/2023
52	TRUPTI DINKAR PATIL	Training on " weighting machine Manufacturing" at Electro India Sangli	3/1/2023-3/2/3023
53	PRATHAMESH SHANKAR MALI	Training on " CCNA" at VIT Computer Institute, Sangli	13/12/2022-13/2/2023
54	OMKAR AJIT SHINDE	Training on " weighting machine Manufacturing" at Electro India Sangli	3/1/2023-3/2/2023
55	SUMEDH BHARAT PATIL	Training on " weighting machine Manufacturing" at Electro India Sangli	3/1/2023-3/2/2023
56	RAMESH PANCHAMRUT PATTANSHETTI	Training on " weighting machine Manufacturing" at Electro India Sangli	2/1/2023-14/2/2023
57	PRATIK SANTOSH PATIL	Training on " weighting machine Manufacturing" at Electro India Sangli	3/1/2023-3/2/2023
58	HARSHVARDHAN VIJAY PATIL	Training on " weighting machine Manufacturing" at Electro India Sangli	3/01/2023-3/02/2023
59	SUMAIYYA RAJU SHAIKH	Training on "C Programming" at Shatrunjay Institute, Sangli	2/12/2022-15/1/2023
60	SAMIKSHA SAMBHAJI HAJARE	Training on" Python Programming" at Intershala	10/09/2022-15/10/2022
61	VISHVAJA CHANDRAKANT JADHAV	Training on " Basics of Data Science" at RacksonsIT Developers Pvt Ltd	23/12/2322-10/02/2023
62	PRATIKSHA RAMCHANDRA CHAVAN	Training on " Basics of Data Science" at RacksonsIT Developers Pvt Ltd	23/12/2322-10/02/2023
63	ATHARVA ABHUEET PHATAK	Training on " weighting machine Manufacturing" at Electro India Sangli	2/1/2023-14/2/2023
64	RUGVED RAMESH KALAL	Training on " Networking and Amezon services" at Domain Computetrs	3/1/2023-10/2/23
65	DHANASHRI BALASAHEB GURAV	Training on " Web development using Python" at Amplifier Electronics	26/12/2023-13/02/2023
66	AKSHAY BALASAHEB PATIL	Training for" Quality control "at Astral Limited	20/08/2022-21/11/2022
67	SANDIP SURESH SAWANT	Training for" Quality control "at Astral Limited	01/09/2022-21/11/2022
68	RUTUJA VIDUR ZENDE	Training on " weighting machine Manufacturing" at Electro India Sangli	2/1/2023-14/2/2023
69	MAYURI TUKARAM JADHAV	Training on " weighting machine Manufacturing" at Electro India Sangli	2/1/2023-14/2/2023
70	SAKSHI MAHADEV CHOUGALE	Training on " weighting machine Manufacturing" at Electro India Sangli	2/1/2023-14/2/2023
71	ASHUTOSH ANIL MAHINDARKAR	Training on " weighting machine Manufacturing" at Electro India Sangli	2/1/2023-14/2/2023
72	KASHIRAM BHAGWAN SHINDE	Training on" Machine drawings of component"at pentagon Industries Pvt Ltd	01/05/2023-30/05/2023
73	NILKAMAL NISHIKANT KAMBLE	Training on" Machine drawings of component"at pentagon Industries Pvt Ltd	01/05/2023-30/05/2023
74	ANKITA RAJENDRA PATIL	Training on " Basics of Data Science" at RacksonsIT Developers Pvt Ltd	23/12/2322-10/02/2023

HOD
(Dept. of ECS Engg)

Principal
Padmabhooshan Vasandraodada Patil
Institute of Technology
BUDHGAON - 416 304

Certificate No **PEL_OPCVMC_PAT_1174**



CERTIFICATE OF PARTICIPATION



NAME **Ms.Sandili Bhosale**

COLLEGE **PADMBHOOSHAN VASANTRAODADA PATIL INSTITUTE OF TECHNOLOGY BUI**

has Successfully Completed
30 DAYS IMAGE PROCESSING USING OPENCV MASTERCLASS

at Pantech e Learning Pvt Ltd, Chennai

From **12.10.2022** To **11.11.2022**

N. Malaiyappan
Director
Pantech e Learning

Dr. Ravi Guggala
Chief General Manager (Technical)
APSSDC

Principal
Padmabhooshan Vasantrodade Patil
Institute of Technology
BUDHGAON - 416 304

Certificate No PEL_OPCVMC_PAT_1187

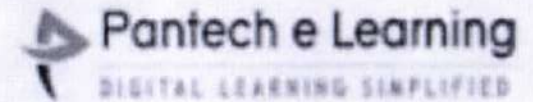

CERTIFICATE OF PARTICIPATION

PANTECH SOLUTIONS®
Technology Beyond The Dreams

NAME Ms. RUTUJA PATIL

COLLEGE PADMBHOOSHAN VASANTRAODADA PATIL INSTITUTE OF TECHNOLOGY BUI

has Successfully Completed
30 DAYS IMAGE PROCESSING USING OPENCV MASTERCLASS

at Pantech e Learning Pvt Ltd, Chennai

From 12.10.2022 To 11.11.2022

M. Malayappan
Director
Pantech e Learning

Dr. Ravi Guggala
Chief General Manager (Technical)
APSSDC

Principal
Padmabhooshan Vasantodada Patil
Institute of Technology
BUDHGAON - 416 304

Certificate No PEL_OPENVVC_PAT_1506

SKILL AP
APSSDC



CERTIFICATE OF PARTICIPATION

NAME

Ms. Arshiya ayub shaikh

COLLEGE

PADMABHOOSHAN VASANTRODADA PATIL INSTITUTE OF TECHNOLOGY BH

has Successfully Completed

30 DAYS IMAGE PROCESSING USING OPENCV MASTERCLASS

at Pantech e Learning Pvt Ltd, Chennai

From 12.10.2022 To 11.11.2022

Principal

Padmabhooshan Vasantrodada Patil
Institute of Technology
BUDHGAON - 416 304

M. Malayappan
Director
Pantech e Learning

Dr. Ravi Gajjala
Chief General Manager (Technical)
APSSDC

Certificate No PEL_OPVMC_PAT_1111



CERTIFICATE OF PARTICIPATION



PANTECH SOLUTIONS
Technology Beyond The Dreams

NAME Mr.TUSHAR VHANMANE

COLLEGE PADMBHOOSHAN VASANTRAODADA PATIL INSTITUTE OF TECHNOLOGY BUI

has Successfully Completed
30 DAYS IMAGE PROCESSING USING OPENCV MASTERCLASS

at Pantech e Learning Pvt Ltd, Chennai

From 12.10.2022 To 11.11.2022

Principal
Padmabhooshan Vasanttraodada Patil
Institute of Technology
BUDHGAON - 416 304

Dr.Ravi Gajjala
Chief General Manager (Technical)
APSSDC

M.Malayappan
Director
Pantech e Learning



INFINITY ELECTRICAL

INFINITY ELECTRICAL

Government Licensed Contractor & Suppliers

Reg. Add.- H. No. 311/1388, I.T.I. Colony, Near Ramkrishna Nagar, Kupwad, Sangli, Maharashtra 416436.

Mobile- 9665396969, 8600500945. Email- infinityelectrical2021@gmail.com

• MC No. 2 14 31 00096 22022021 • MS No. 2 14 11 00147 09112020 • GST No. 27AYTPC6151F1ZB

Place: Sangli

Date: 14 -Nov- 2022

CERTIFICATE OF INDUSTRIAL TRAINING

This is to certify that Ms. **AISHWARYA PAYAGONDA PATIL** of Third Year B.Tech in Electronics Engineering from Padmabhooshan Vasantraodada Patil Institute of Technology, Budhagaon, Sangli. has successfully completed 1 months of (from 10 Oct. 2022 to 10 Nov. 2022) Industrial training at Infinity Electrical, Sangli.

During this period of training with us, she has been found punctual, hardworking & inquisitive.

We wish her every success in her future endeavours.

Principal
Padmabhooshan Vasantraodada Patil
Institute of Technology
BUDHGAON - 416 304

For the "INFINITY ELECTRICAL",

Authorized Signatory

* SANGLI *

Reg. Office: H. No. 311/1388 ITI Colony Kupwad, Sangli, Maharashtra 416436.

Mob: +91 9665396969

Email: infinityelectrical2021@gmail.com

Certificate No PEL_OPCVMC_PAT_1127

SKILL AP
APSSDC



CERTIFICATE OF PARTICIPATION

NAME Ms. VIDYA SAGARE

COLLEGE PADMBHOOSHAN VASANTRAODADA PATIL INSTITUTE OF TECHNOLOGY BUI

has Successfully Completed
30 DAYS IMAGE PROCESSING USING OPENCV MASTERCLASS

at Pantech e Learning Pvt Ltd, Chennai

From 12.10.2022 To 11.11.2022

M. Mahalingam
Director
Pantech e Learning

Dr. Kavi Sagar
Chief General Manager (Technical)
APSSDC

Principal
Padmabhoshan Vasanttraodada Patil
Institute of Technology
BUDHGAON - 416 304



Certificate No PEL_OPCVMC_PAT_111



Skill AP
APSSDC

 **Pantech e Learning**
DIGITAL LEARNING SIMPLIFIED

CERTIFICATE OF PARTICIPATION

PANTECH SOLUTIONS
Technology Beyond The Dreams

NAME Mr. Shaikh Imtiyaj Hanif
COLLEGE P.V.P.I.T. BUDHGAON

has Successfully Completed
30 DAYS IMAGE PROCESSING USING OPENCV MASTERCLASS

at Pantech e Learning Pvt Ltd, Chennai

From 12.10.2022 To 11.11.2022

M. Malaiyappan
Director
Pantech e Learning

Dr. Ravt Gujjala
Chief General Manager (Technical)
APSSDC

Principal
Dadamabhooshan Vasantrodade Patil
Institute of Technology
BUDHGAON - 416 304



INFINITY ELECTRICAL

INFINITY ELECTRICAL

Government Licensed Contractor & Suppliers

Reg. Add.- H. No. 311/1388, I.T.I. Colony, Near Ramkrishna Nagar, Kupwad, Sangli, Maharashtra 416436.

Mobile- 9665396969, 8600500945 Email- infinityelectrical2021@gmail.com

• MC No. 2 14 31 00096 22022021

• MS No. 2 14 11 00147 09112020

• GST No. 27AYTPC6151F1ZB

Place: Sangli

Date: 14 -Nov- 2022

CERTIFICATE OF INDUSTRIAL TRAINING

This is to certify that Mr. **HARSHAD VIJAYKUMAR CHAVAN.** of Third Year B.Tech in Electronics Engineering from Padmabhooshan Vasantrodada Patil Institute of Technology, Budhagaon, Sangli. has successfully completed 1 months of (from 10 Oct. 2022 to 10 Nov. 2022) Industrial training at Infinity Electrical, Sangli.

During this period of training with us, he has been found punctual, hardworking & inquisitive.

We wish him every success in his future endeavours.

Principal
Padmabhooshan Vasantrodada Patil
Institute of Technology
BUDHGAON - 418 304

For the "INFINITY ELECTRICAL",

Authorized Signatory.
* SANGLI *

Reg. Office: H. No. 311/1388 ITI Colony Kupwad, Sangli, Maharashtra 416436.

Mob: +91 9665396969

Email ID: infinityelectrical2021@gmail.com

Certificate No PEL_OPVMC_PAT_1189



SKILL AP
APSSDC

CERTIFICATE OF PARTICIPATION

NAME Ms. PRADNYA UBALE

COLLEGE PADMBHOOSHAN VASANTRAODADA PATIL INSTITUTE OF TECHNOLOGY BUI

has Successfully Completed
30 DAYS IMAGE PROCESSING USING OPENCV MASTERCLASS

at Pantech e Learning Pvt Ltd, Chennai

From 12.10.2022 To 11.11.2022

M. Mahalingam
Director
Pantech e Learning

Dr. Kavi Sankar
Chief General Manager (Technical)
APSSDC

Principal
Padmabhooshan Vasantraodada Patil
Institute of Technology
BUDHGAON - 416 304

 Pantech e Learning
DIGITAL LEARNING SIMPLIFIED

 PANTECH SOLUTIONS
Technology Beyond The Screen

Achievement



CERTIFICATE
OF COMPLETION

Pregrad program is certifies that

Dhiraj Pawar

has successfully completed
Python Certification Course
and has fundamental knowledge of Python.

Granted on February 16, 2023



Detector
pregrad



Principal
Padmabhooshan Vasantraodade Patil
Institute of Technology
BUDHGAON - 416 304



CERTIFICATE OF COMPLETION

Presented to

Uzma Khatib

For successfully completing a free online course
Python Fundamentals for Beginners

Provided by

Great Learning Academy

(On July 2022)

Principal
Padmabhoshan Vasantodade Patil
Institute of Technology
BUDHGAON - 416 304

Certificate of Training

SHINDE SNEHA DADASO,

Student of PVPIT, SANGLI has successfully completed an four weeks online training on Programming with C++ from 16th Nov 2022 to 15th Dec 2022. The training consisted of Getting started.

With Programming in C++, Fundamentals of object oriented programming using C++ and Diving into C++ Programming modules. In the final assessment Imtiyaj scored 82% marks.

We wish Imtiyaj all the best to his future endeavors.

Sarvesh

Sarvesh Aggarwal
Founder & CEO, Internshala

Principal
Padmabhooshan Vasantodade Patil
Institute of Technology
BUDHGAON - 416 304



MANUFACTURER, SALES & SERVICES OF
ELECTRONIC WEIGHING MACHINE
An ISO 9001:2008 Certified Company

LG ELECTRO INDUSTRIES

- 📍 CORPORATE OFFICE
PLOT NO. 20, GHANSHYAM NAGAR, MADHAVNAGAR ROAD,
SANGLI - 416 416 (MAHARASHTRA) PH : 0233-2314242
- ✉ Email : electroindia14@gmail.com | electroindiaindustries@gmail.com
- 📞 Mobile : 9422508828, 9422409458 | www.electro-india.in

Date - 1 /10/ 2022

TRAINING CERTIFICATE

This is to certify that, **Mr.Nilesh Nayan Kulkarni**, of Degree **T.Y.Electronics** from the College **PVPIT Budhgaon** has completed Industrial Training in **Electro India Sangli** in the Period of **1 Sep. 2022 to 30 Sept. 2022**. According to this he completed **4 week** training.

In the training period we found him a sincere, honest, hardworking, dedicated trainee with a professional attitude and very good job knowledge. In this duration we gave him training of all types of weighing machines in two sections namely hardware section and software section . We found him work satisfactory because of his sincerity, dedication and hard work.

We have found him to be a self starter who is new invention view. We wish him all the best and success in future career.

For Electro-India

(Authorized Signatory)



(Signature)
Principal
Paamabhooshar Vasantraodada Patil
Institute of Technology
BUDHGAON - 416 304



आपला प्रत्येक ग्रॅम हाकाचा....इलेक्ट्रो इंडिया...!



Certificate of Training

Sarfaraj M Pathan

Student of **PVPIT,SANGLI** has successfully completed an four weeks online training on Programming with C++ from 31st Oct 2022 to 15th Dec 2022. The training consisted of Getting started.

With Programming in C++, Fundamentals of object oriented programming using C++ and Diving into C++ Programming modules. In the final assessment Imtiyaj scored 82% marks. We wish Imtiyaj all the best to his future endeavors.

Sarvesh

Sarvesh Aggarwal
Founder & CEO, Internshala

Principal
Padmabhooshan Vasantraodade Pati
Institute of Technology
BUDHGAON - 416 304

GOMTESH COMPUTER INSTITUTE

Sant Dnyaneshwar Nagar, A/p. Budhgaon

Tal. – Miraj, Dist. – Sangli

Mobile No. 9175703090

Date: 17 Dec 2022

To Whomsoever It May Concern

Mr. Shubham Sambhaji Kadam has completed successfully 45 Hrs. of Certificate course in “C- Programming Language” with A+ grade in the month of Dec 2022.



Sign & Seal of Institute

Principal
Padmabhooshan Vasantodade Pati
Institute of Technology
BUDHGAON - 416 304



ELECTRO - INDIA

Best Way to Weigh

MANUFACTURER, SALES & SERVICES OF
ELECTRONIC WEIGHING MACHINE
An ISO 9001:2008 Certified Company

LG ELECTRO INDUSTRIES

- CORPORATE OFFICE**
PLOT NO. 20, GHANSHYAM NAGAR, MADHAVNAGAR ROAD,
SANGLI - 416 416. (MAHARASHTRA) PH : 0233-2314242
- Email : electroindia14@gmail.com || electroindiaindustries@gmail.com
- Mobile : 9422506828, 9422409458 || www.electro-india.in

Date - 1/10/ 2022

TRAINING CERTIFICATE

This is to certify that, **Mr.Prathmesh Sunil Parit** of Degree **T.Y.Electronics** from the College **PVPIT Budhgaon** has completed Industrial Training in **Electro India Sangli** in the Period of **1 Sep. 2022 to 30 Sept. 2022**. According to this he completed **4 week** training.

In the training period we found him a sincere, honest, hardworking, dedicated trainee with a professional attitude and very good job knowledge. In this duration we gave him training of all types of weighing machines in two sections namely hardware section and software section . We found him work satisfactory because of his sincerity, dedication and hard work.

We have found him to be a self starter who is new invention view. We wish him all the best and success in future career.

For Electro-India



(Authorized Signatory)

Principal
Padmabhooshan Vasantodade Patil
Institute of Technology
BUDHGAON - 416 304



आपला प्रत्येक ग्रॅम हक्काचा....इलेक्ट्रो इंडिया...!

Principal
Sasamabhooshan Vasantadada Patil
Institute of Technology
BUDHGAON - 416 304

M. Mane



Dr. 05.06.2022

Kupwad, Sangli- 416 436

For Magnewin Energy Pvt. Ltd

Place: K-2 M.I.D.C.

future endeavors.

to the best of our knowledge. We wish all the best for his

He was found to be sincere, punctual, curious & hard working

04.05.2022 to 05.06.2022

at our works. During the internship scheduled between

Has satisfactorily completed his industrial internship scheduled

1st Year E&CS Engineering

student of (Degree)

a

Mr. Mane Aryan Nitin.

This is to certify that

OF INDUSTRIAL INTERNSHIP

CERTIFICATE



Certificate of Training

Snehal Pawar

has successfully completed an 8-week online training on **Programming with C and C++**. The training consisted of Getting Started With Programming in C, Diving Into C Programming, Fundamentals of Object Oriented Programming Using CPP, Diving into CPP Programming, and Building Cricket Game Application modules.

Snehal scored 96% marks in the final assessment and is a top performer in the training.

We wish Snehal all the best for future endeavours.



Sarvesh Agarwal

FOUNDER & CEO, INTERNSHALA



Principal

Padmabhooshan Vasantodade Patil
Institute of Technology
BUDHGAON - 416 304

Date of certification: 2022-11-08 Certificate no.: 50C8EDC6-CC3A-E427-8187-BDCDC28F16C4

For certificate authentication, please visit https://trainings.internshala.com/verify_certificate

ADITYA INFOTECH

Software Development Made Easy

Ref. No.: Nov/2022/7

Date: 19/11/2022

TO WHOM IT MAY CONCERN

This is to certify that **Ms. Payal S. Bhosale** has completed training on 'Web Essentials'. During this period she was trained to work on following:

1. Internet Fundamentals
2. HTML
3. CSS
4. JAVASCRIPT
5. LIVE Upload of Website

Her performance, behavior and attitude during this period were good.



Mr. Sachin Khot

[Technical Head]

Aditya Infotech



Principal
Padmabhooshan Vasantodade Paul
Institute of Technology
BUDHGAON - 416 304





Certifies that

Niranjan Uday Patil

Of Sangli *Centre*

has successfully passed

C Programming

in the month of Feb. 23

In testimony whereof is set the seal of the said Institute.



Mumbai

Dt. : 17-02-2023

S N G 9 7 0 5

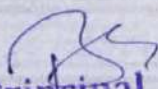
Principal
Padmabhooshan Vasantodade Patil
Institute of Technology
BUDHGAON - 416 304

Authorised Signatory

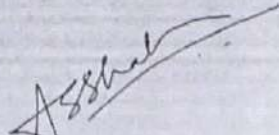
Director



Certifies that

Swapnil Sunil Mali

Of _____ Sangli _____ Centre

has successfully passed

C Programming

in the month of _____ Feb. 23 _____.

In testimony whereof is set the seal of the said Institute.



Mumbai

Dt. : 17-02-2023

S N G 9 7 2 8

Principal
Paamabhooshan Vasantraodade Patil
Institute of Technology
BUDHGAON - 416 304

Authorised Signatory

Director

i con

INDIA CONTROL

Mfg. :Auto Switch, Control Panels, Capacitors

Tank Controller, Starter, ELCB, Mobile Auto.

Chinmay Park, Yashwantnagar,
KUPWAD. Dist. Sangli.

Mobile : 980380233, 7972127700

Date : 2/12/2022

Mr. Vishvajeet Nanaso Chavan

**Has successfully completed the 40 days Industrial
training of Control Panels.**

Training Period : 20 Oct 2022 to 30 Nov 2022

Principal
Dadmahooshan Vasantodaze Patil
Institute of Technology
BUDHGAON - 416 304

Instructor

I CON
INDIA CONTROLS
SANGLI.

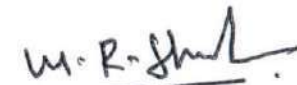

Director

Certificate of Training

Shrawani Nikam

from Padmabhushan vasantrao dada patil Institute of Technology, Budhgaon. has successfully completed a 6-week online training on **Programming with Python**. The training consisted of Introduction to Python, Using Variables in Python, Basics of Programming in Python, Principles of Object-oriented Programming (OOP), Connecting to SQLite Database, Developing a GUI with PyQt, Application of Python in Various Disciplines, and The Final Project modules.

Shrawani scored 95% marks in the final assessment and is a top performer in the training.

We wish Shrawani all the best for future endeavours.



Sarvesh Agarwal
FOUNDER & CEO, INTERNSHALA



Principal
Padmabhushan Vasantraodada Patil
Institute of Technology
BUDHGAON - 416 304

Date of certification: 2023-03-04

Certificate no. : 1klahx1jq60

For certificate authentication, please visit https://trainings.internshala.com/verify_certificate



VIT COMPUTER EDUCATION CENTER

An ISO 9001 : 2015 Certified Institute

Course Objectives

- COMPUTER NETWORKING (N+)
- CISCO CERTIFIED NETWORK ASSOCIATE
CCNA (EXAM 200 - 301)

CERTIFICATE

This is to Certified that Prathmesh Shankar Mali has successfully completed, examined & found proficient In Advanced Computer Networking Course Designed, Developed & Offered by our Institute during the period Dec 2022 to Feb 2023 and has been placed in grade ' A '

Principal
Padmabhooshan Vasantodad2 Patil
Institute of Technology
BUDHGAON - 416 304

Authorised Signatory

Certificate No : VCTC00418



Certificate of Training

Samikasha Hajare

from PVPIT Bughagaon college has successfully completed a 6-week online training on **Programming with Python**. The training consisted of Introduction to Python, Using Variables in Python, Basics of Programming in Python, Principles of Object-oriented Programming (OOP), Connecting to SQLite Database, Developing a GUI with PyQT, Application of Python in Various Disciplines, and The Final Project modules.

In the final assessment, Samikasha scored 46% marks.

We wish Samikasha all the best for future endeavours.



Sarvesh Agarwal

FOUNDER & CEO, INTERNSHALA



Principal
Padmabhooshan Vasantodade Patil
Institute of Technology
BUDHGAON - 416 111

Date of certification: 2022-10-15

Certificate no. : B925A640-A807-AC77-05EF-E037C8DFE84B

For certificate authentication, please visit https://trainings.internshala.com/verify_certificate

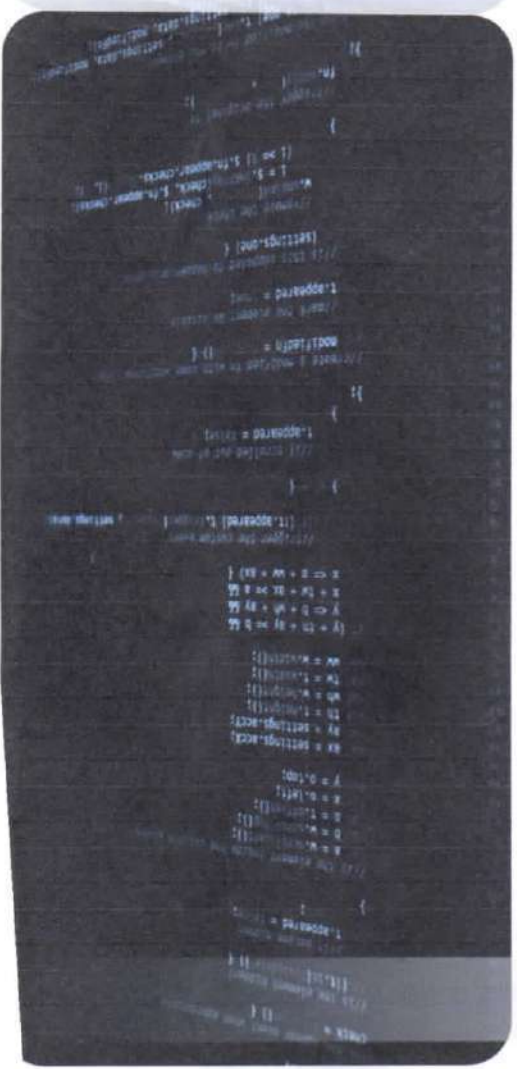

CERTIFICATE OF COMPLETION



THIS IS CERTIFY THAT

VISHVJA JADHAV

Successfully completed Internship in Basics of Data Science using python. Duration: **6 Weeks** conducted by RacksonsIT Developers Pvt Ltd. Pune and Trainer and Consultant

Mr. Abhay Chougule.

Date: 23/12/2022 to 10/02/2023



PUNE

ABHAY CHOUGULE
FOUNDER & CEO
8237180203

Principal
Pamabhoshan Vasantadaas Patil
Institute of Technology
BUDHGAON - 416 304

CERTIFICATE OF COMPLETION



THIS IS CERTIFY THAT

PRATIKSHA CHAVAN

Successfully completed Internship in Basics of Data Science using python. Duration: **6 Weeks** conducted by RacksonsIT Developers Pvt Ltd. Pune and Trainer and Consultant

Mr. Abhay Chougule.

Date: 23/12/2022 to 10/02/2023



PUNE

ABHAY CHOUGULE

FOUNDER & CEO

8237180203

Principal
Pamabhoshan Vasantgadage Patil
Institute of Technology
BUDHGAON - 416 304





MANUFACTURER, SALES & SERVICES OF
ELECTRONIC WEIGHING MACHINE
An ISO 9001:2008 Certified Company

LG ELECTRO INDUSTRIES

- 📍 **CORPORATE OFFICE**
PLOT NO. 20, GHANSHYAM NAGAR, MADHAVNAGAR ROAD,
SANGLI - 416 416. (MAHARASHTRA) PH : 0233-2314242
- ✉ Email : electroindia14@gmail.com ■ electroindiaindustries@gmail.com
- 📞 Mobile : 9422506828, 9422409458 ■ www.electro-india.in

Date -16 /2 /23

INTURNSHIP CERTIFICATE

This is to certify that, **Mr.Atharv Abhijeet Phatak**. Of Degree **2nd yr Electronics & Computer Science** from the College **PVPIT Budhgaon** has completed Industrial Training in **Electro India Sangli** in the Period of **2 Jan .2023 to 14 Feb.2023**.According to this he completed **6 week training**.

In the training period we found him a sincere, honest, hardworking, dedicated trainee with a professional attitude and very good job knowledge. In this duration we gave him training of all types of weighing machines in two sections namely hardware section and software section . We found him work satisfactory because of his sincerity, dedication and hard work.

We have found him to be a self starter who is new invention view. We wish him all the best and success in future career.

For Electro-India

(Authorized Signatory)



Principal
Padmabhooshan Vasantodade Patil
Institute of Technology
BUDHGAON - 416 304



आपला प्रत्येक ग्रॅम हक्काचा....इलेक्ट्रो इंडिया...!



AMPLIFIER ELECTRONICS PVT. LTD.

Embedded Systems & Website Development
We Amplify Your Ambitions.



INDUSTRY TRAINING CERTIFICATION

This Certificate is awarded to

Miss. Dhanashri Balaso Gurav

For successfully completing the industrial Training of
"Web Development using Python"

From 26 December 2022 to 13 February 2023



CIN No. U72900PN2020PT196550
Certificate No. AE-2021-22-150971-344-50

Mr. Sagar Shinde
Director
Amplifier Electronics Pvt. Ltd., Karad

Mr. Jayram Patil
Web Developer & Trainer
Amplifier Electronics Pvt. Ltd., Karad

Principal
Padmabhooshan Vasantodade Patil
Institute of Technology
BUDHGAON - 416 304

Dr. V. P. S. S. M.'s
Padmabhooshan Vasantrodada Patil Institute of
Technology, Budhgaon Sangli

Certificate



"YOU TUBE VIDEO DOWNLODER USING PYTHON"

This is to Certify that, above project work is carried out in Department of Electronics Engineering by

Anjali Pandit Mohite	T2162691376506
Aditi Narayan Abhyankar	T2162691376530
Vaibhav Prakash Vibhute	T2162691376511

In partial fulfilment of requirement as a part of syllabus by **Dr. Babasaheb Ambedkar Technological University, Lonere** for the course **T. Y. B. Tech. Electronics Engineering** during the academic year **2022-23, Semester - II** under my guidance

Mr. K. K. Pandeyaji
Guide

Prof. R. D. Patil
HOD

Prof. Dr. D. V. Ghewade
Principal

Dr. V. P. S. S. M.'s
Padmabhooshan Vasantodada Patil Institute of
Technology, Budhgaon Sangli

Certificate



“WIRELESS NOTICE BOARD”

This is to Certify that, above project work is carried out in Department of Electronics Engineering by

Mr. Apurv Atul Kharade.	T2162691376549
Mr. Rushikesh Ashok Kadam.	T2162691376544
Mr. Pratik Ashok Sadare.	T2162691376543
Mr. Harshvardhan Arvind Savant.	T2162691376523

In partial fulfilment of requirement as a part of syllabus by Dr. Babasaheb Ambedkar Technological University, Lonere for the course T. Y. B. Tech. Electronics Engineering during the academic year 2022-23, Semester - II under my guidance

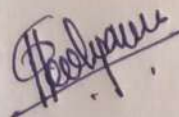
Mr. K. K. Pandeyaji
Guide

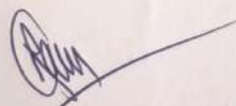
Prof. R. D. Patil
HOD

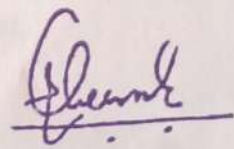
Prof. Dr. D. V. Ghewade
Principal

Dr. V. P. S. S. M.'s

**Padmabhooshan Vasantraodada Patil Institute of
Technology, Budhgaon Sangli**

Certificate



“SMART DUSTBIN”

This is to Certify that, above project work is carried out in Department of Electronics Engineering by

**Aditya Sudhir Waghmare
Om Milind Dhamanage
Pramod Abhay Alate**

In partial fulfilment of requirement as a part of syllabus by **Dr. Babasaheb Ambedkar Technological University, Lonere** for the course **T. Y. B. Tech.** during the academic year **2022-23** under my guidance

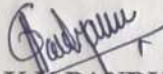
Mr. K.K. PANDYAJI
Guide

Prof. R. D. Patil
HOD

Prof. Dr. D. V. Ghewade
Principal

Dr. V. P. S. S. M.'s
Padmabhooshan Vasantraodada Patil Institute of
Technology, Budhgaon Sangli

Certificate





“WIFI CONTROLLED ROBOT”

This is to Certify that, above project work is carried out in Department of Electronics Engineering by

Jainab Firoz Pinjari.	2162691376541
Sneha Dadaso Shinde.	2062691376013
Pranali Vishwas Devkule.	2162691376509

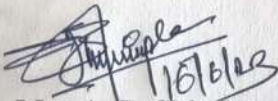
In partial fulfilment of requirement as a part of syllabus by Dr. Babasaheb Ambedkar Technological University, Lonere for the course T. Y. B. Tech. Electronics Engineering during the academic year 2022-23, Semester - II under my guidance

Mr. A. B. Shinde
Guide

Prof. R. D. Patil
HOD

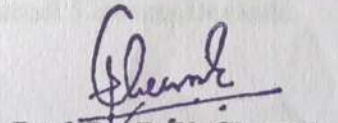
Prof. Dr. D. V. Ghewade
Principal

Dr. V. P. S. S. M.'s

Padmabhooshan Vasanttraodada Patil Institute of Technology,
Budhgaon Sangli

Certificate



“Pulse Oximeter Using Arduino”

This is to Certify that, above project work is carried out in Department of Electronics Engineering by

Shruti Tasgoankar	2062691376012
Snehal Mali	2062691376023
Pallavi manugade	2062691376022
Sarfaraj Pathan	2062691376008

In partial fulfilment of requirement as a part of syllabus by **Dr. Babasaheb Ambedkar Technological University, Lonere** for the course **T. Y. B. Tech. Electronics Engineering** during the academic year **2022-23, Semester - II** under my guidance

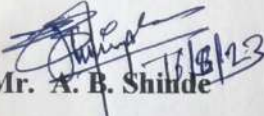
Mr. A. B. Shinde
Guide

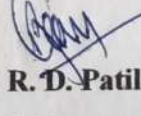
Prof. R. D. Patil
HOD

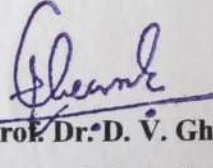
Prof. Dr. D. V. Ghewade
Principal

Dr. V. P. S. S. M.'s
Padmabhooshan Vasantraodada Patil Institute of
Technology, Budhgaon Sangli

Certificate





“Bluetooth Control Robot”

This is to Certify that, above project work is carried out in Department of Electronics Engineering by

Harshwardhan Yashwant Chougale	T2162691376532
Pruthviraj Chandrakant Mane	T2162691376521
Tanmay Pradip Mankani	T2062691376015

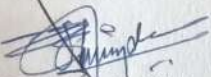
In partial fulfilment of requirement as a part of syllabus by **Dr. Babasaheb Ambedkar Technological University, Lonere** for the course **T. Y. B. Tech. Electronics Engineering** during the academic year **2022-23, Semester - II** under my guidance

Mr. A. B. Shinde
Guide

Prof. R. D. Patil
HOD

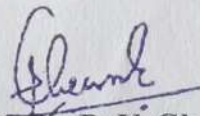
Prof. Dr. D. V. Ghewade
Principal

2022-23

Dr. V. P. S. S. M.'s
Padmabhooshan Vasantraodada Patil Institute of
Technology, Budhgaon Sangli



Certificate

"Road Accident Prevention System"

This is to Certify that, above project work is carried out in
Department of Electronics Engineering by

Name	PRN
Nauman Zakirhusen Shaikh	1962691376009
Shivani Shivling Sankpal	2062691376011
Komal Sandeep Patil	2062691376004

In partial fulfilment of requirement as a part of syllabus by
Dr. Babasaheb Ambedkar Technological University, Lonere for
the course T. Y. B. Tech. Electronics Engineering during the
academic year 2022-23, Semester - II under my guidance.

Miss. A.S. Bhandare
Guide

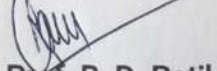
Prof. R. D. Patil
HOD

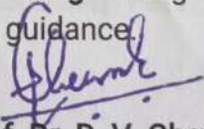
Prof. Dr. D. V. Ghewade
Principal

Dr. V. P. S. S. M.'s
Padmabhooshan Vasanttraodada Patil Institute of
Technology, Budhgaon Sangli

Certificate



“SMART VACUUM CLEANER ROBOT USING ARDUINO UNO”

This is to Certify that, above project work is carried out in Department
of Electronics Engineering by

Suhana Mahamud Magdum	T2162691376545
Uzma Miyalal Khatib	T2162691376504
Supriya Gurappa Mhetre	T2162691376550

In partial fulfilment of requirement as a part of syllabus by
Dr. Babasaheb Ambedkar Technological University, Lonere for the
course T. Y. B. Tech. Electronics Engineering during the academic
year 2022-23, Semester - II under my guidance

Dr. K. K. Pandiyaji
Guide

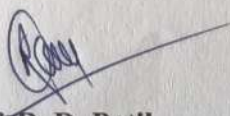
Prof. R. D. Patil
HOD

Prof. Dr. D. V. Ghewade
Principal

Dr. V. P. S. S. M.'s

**Padmabhooshan Vasanttraodada Patil Institute of
Technology, Budhgaon Sangli**

Certificate



“Face detection system using python”

This is to Certify that, above project work is carried out in Department of Electronics Engineering by

**Shraddha Ravaso Chougule
Pratiksha suresh pawar
Shweta shivaji patil**

**2162691376548
2162691376527
2162691376551**

In partial fulfilment of requirement as a part of syllabus by **Dr. Babasaheb Ambedkar Technological University, Lonere** for the course **T. Y. B. Tech.** during the academic year **2022-23** under my guidance

Prof. K. K. Pandey
Guide

Prof. R. D. Patil
HOD

Prof. Dr. D. V. Ghewade
Principal

2022-23

Dr. V. P. S. S. M.'s
Padmabhooshan Vasantrodada Patil Institute of
Technology, Budhgaon Sangli.

Certificate



“Footstep Power Generation”

This is to Certify that, above project work is carried out in Department of
Electronics Engineering by

Prajyot Prashant Sathaye
Dhiraj Manik Pawar

In partial fulfilment of requirement as a part of syllabus by **Dr. Babasaheb
Ambedkar Technological University, Loner** for the course **T. Y. B. Tech.**
during the academic year **2022-23** under my guidance

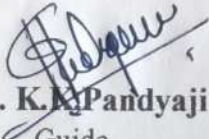
Dr. K. M. Pandeyaji
Guide

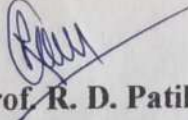
Prof. R. D. Patil
HOD

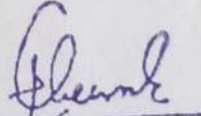
Prof. Dr. D. V. Ghewade
Principal

Dr. V. P. S. S. M.'s
Padmabhooshan Vasantoraodada Patil Institute of
Technology, Budhgaon Sangli

Certificate



“SMART BLIND STICK USING ARDUINO”

This is to Certify that, above project work is carried out in Department of Electronics Engineering by

Aniket Sanjay Chavan	2062691376019
Gajanan Govindrao Jadhav	2062691376003
Shivratna Ramchandra Patil	2162691376519

In partial fulfilment of requirement as a part of syllabus by **Dr. Babasaheb Ambedkar Technological University, Lonere** for the course **T. Y. B. Tech. Electronics Engineering** during the academic year **2022-23, Semester - II** under my guidance

Miss. A. S. Bhandare
Guide

Prof. R. D. Patil
HOD

Prof. Dr. D. V. Ghewade
Principal

Dr. V. P. S. S. M.'s

**Padmabhooshan Vasanthaodada Patil Institute of
Technology, Budhgaon Sangli**

Certificate



“pH Testing And Neutralization”

This is to Certify that, above project work is carried out in Department of Electronics Engineering by

**Vrushali Subhash Godase
Sanika Santosh Mane
Sharwari Sanjay Gaikwad**

In partial fulfilment of requirement as a part of syllabus by **Dr. Babasaheb Ambedkar Technological University, Lonere** for the course **T. Y. B. Tech. Electronics Engineering** during the academic year **2022-23, Semester - II** under my guidance

Miss. A. S. Bhandare
Guide

Prof. R. D. Patil
HOD

Prof. Dr. D. V. Ghewade
Principal

Dr. V. P. S. S. M.'s
Padmabhooshan Vasantodada Patil Institute of
Technology, Budhgaon Sangli.

Certificate



“Dual Axis Solar Tracking System”

This is to Certify that, above project work is carried out in Department of
Electronics Engineering by

Akash Sanjay Pawaskar
Vighnaraj Dinkar Mohite
Ajay Khandu Kumbhar
Yash Ramesh Chavan

In partial fulfilment of requirement as a part of syllabus by **Dr. Babasaheb
Ambedkar Technological University, Lonar** for the course **T. Y. B. Tech.**
during the academic year **2022-23** under my guidance

Mis.A.S.Bhandare
Guide

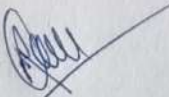
Prof. R. D. Patil
HOD

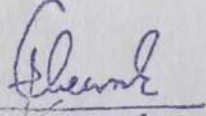
Prof. Dr. D. V. Ghewade
Principal

Dr. V. P. S. S. M.'s
Padmabhooshan Vasantraodada Patil Institute of
Technology, Budhgaon Sangli.

Certificate



“Smart landmines”

This is to Certify that, above project work is carried out in Department of
Electronics Engineering by

1. Shraddha Deshmukh
2. Gauri Nakate.

In partial fulfilment of requirement as a part of syllabus by **Dr. Babasaheb Ambedkar Technological University, Lonere** for the course **T.Y.B. Tech** during the academic year **2022-23** under my guidance

Prof. A. S. Bhandare
Guide

Prof. R. D. Patil
HOD

Prof. Dr. D. V. Ghewade
Principal

Dr. V. P. S. S. M.'s
 Padmabhooshan Vasantraodada Patil Institute of Technology,
 Budhgaon Sangli

Certificate



“Pulse Oximeter Using Arduino”

This is to Certify that, above project work is carried out in Department of Electronics Engineering by

Shruti Tasgoankar	2062691376012
Snehal Mali	2062691376023
Pallavi manugade	2062691376022
Sarfaraj Pathan	2062691376008

In partial fulfilment of requirement as a part of syllabus by **Dr. Babasaheb Ambedkar Technological University, Lonere** for the course **T. Y. B. Tech. Electronics Engineering** during the academic year **2022-23, Semester - II** under my guidance

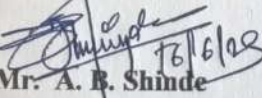
 Mr. A. B. Shinde

Guide

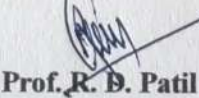
 Prof. R. B. Patil

HOD

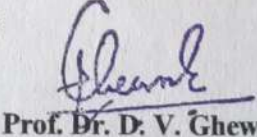
 Prof. Dr. D. V. Ghewade

Principal

2022-23

Dr. V. P. S. S. M.'s
Padmabhooshan Vasantrodada Patil Institute of
Technology, Budhgaon Sangli

Certificate



“IoT Based Water Quality Monitoring System”

This is to Certify that, above project work is carried out in Department of Electronics Engineering by

Sakshi Sachin Magdum	2162691376517
Srushti Basavraj Pachhapure	2062691376018
Divya Arun Irale	2162691376518
Aishwarya Sampatrao Mohite	2162681376539

In partial fulfilment of requirement as a part of syllabus by Dr. Babasaheb Ambedkar Technological University, Lonere for the course T. Y. B. Tech. Electronics Engineering during the academic year 2022-23, Semester - II under my guidance

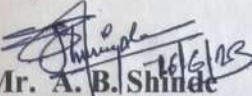
Mr. A. B. Shinde
Guide

Prof. R. D. Patil
HOD

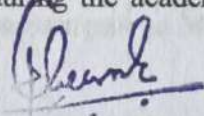
Prof. Dr. D. V. Ghewade
Principal

Dr. V. P. S. S. M.'s
Padmabhooshan Vasanttraodada Patil Institute of
Technology, Budhgaon Sangli

Certificate



“SMART STREET LIGHT & ENERGY CONSERVATION”

This is to Certify that, above project work is carried out in Department of Electronics Engineering by

Pranav Tulshiram Kharat	T2162691376522
Pranjali Dattatray Gavade	T2162691376537
Monika Shrikant Mane	T2162691376540

In partial fulfilment of requirement as a part of syllabus by Dr. Babasaheb Ambedkar Technological University, Lonere for the course T. Y. B. Tech. Electronics Engineering during the academic year 2022-23, Semester - II under my guidance

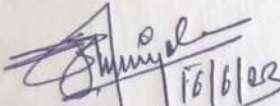
Mr. A. B. Shinde
Guide

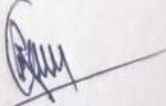
Prof. R. D. Patil
HOD

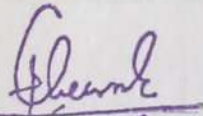
Prof. Dr. D. V. Ghewade
Principal

Dr. V. P. S. S. M.'s
Padmabhooshan Vasantraodada Patil Institute of
Technology, Budhgaon Sangli.

Certificate



“Sun Tracking Solar Panel Using Arduino”

This is to Certify that, above project work is carried out in Department of
Electronics Engineering by

Shubham Sambhaji Kadam
Abhijit Bapu Hubale

In partial fulfilment of requirement as a part of syllabus by **Dr. Babasaheb
Ambedkar Technological University, Loner** for the course **T. Y. B. Tech.**
during the academic year **2022-23** under my guidance

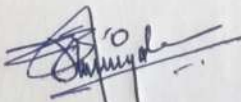
Mr. A. B. Shinde
Guide

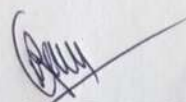
Prof. R. D. Patil
HOD

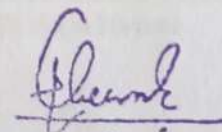
Prof. Dr. D. V. Ghewade
Principal

Dr. V. P. S. S. M.'s
Padmabhooshan Vasantraodada Patil Institute of
Technology, Budhgaon Sangli

Certificate





"Fire Fighting Robot"

This is to Certify that, above project work is carried out in Department
of Electronics Engineering by

Name	PRN.no
Aditya Rajendra Patil	T2062691376021
Akash Hari Kolekar	T2162691376535
Gitanjalee Sitaram Gurav	T2162691376534

In partial fulfilment of requirement as a part of syllabus by
Dr. Babasaheb Ambedkar Technological University, Lonere for the
course T. Y. B. Tech. Electronics Engineering during the academic year
2022-23, Semester - II under my guidance

Mr. A. B. Shinde
Guide

Prof. R. D. Patil
HOD

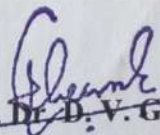
Prof. Dr. D. V. Ghewade
Principal

Dr. V. P. S. S. M.'s
Padmabhooshan Vasantraodada Patil Institute of
Technology, Budhgaon Sangli

Certificate



“WIFI CONTROLLED ROBOT”

This is to Certify that, above project work is carried out in Department of Electronics Engineering by

Jainab Firoz Pinjari.	2162691376541
Sneha Dadaso Shinde.	2062691376013
Pranali Vishwas Devkule.	2162691376509

In partial fulfilment of requirement as a part of syllabus by Dr. Babasaheb Ambedkar Technological University, Lonere for the course T. Y. B. Tech. Electronics Engineering during the academic year 2022-23, Semester - II under my guidance

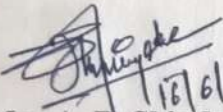
16/6/23
Mr. A. B. Shinde
Guide

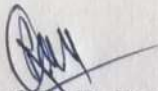
Prof. R. D. Patil
HOD

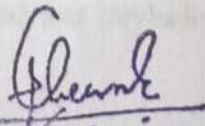
Prof. Dr. D. V. Ghewade
Principal

Dr. V. P. S. S. M.'s
Padmabhooshan Vasantraodada Patil Institute of
Technology, Budhgaon Sangli

Certificate



“Distance Measurement Using Arduino & Ultrasonic Sensor”

This is to Certify that, above project work is carried out in Department of Electronics Engineering by

Apurv Atul Kharade

T2162691376549

Rushikesh Ashok Kadam

T2162691376544

Pratik Ashok Sadare

T2162691376543

In partial fulfilment of requirement as a part of syllabus by Dr. Babasaheb Ambedkar Technological University, Lonere for the course T. Y. B. Tech. during the academic year 2022-23 under my guidance

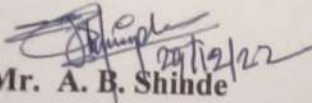
Mr. A. B. Shinde
Guide

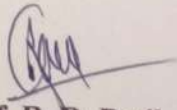
Prof. R. D. Patil
HOD

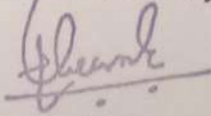
Prof. Dr. D. V. Ghewade
Principal

Dr. V. P. S. S. M.'s
Padmabhooshan Vasantraodada Patil Institute of Technology,
Budhgaon Sangli

Certificate



“SOIL MOISTURE DETECTOR USING ARDUINO”

This is to Certify that, above project work is carried out in Department of
Electronics Engineering by

Akash sanjay pawaskar 2062691376001
Ajay khandu kumbhar 2062691376002
Vignaraj dinkar mohite 2062691376016

In partial fulfilment of requirement as a part of syllabus by **Dr. Babasaheb
Ambedkar Technological University, Lonere** for the course **T. Y. B. Tech.**
during the academic year **2022-23** under my guidance

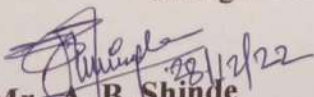
Mr. A. B. Shinde
Guide

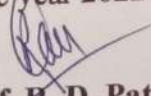
Prof. R. D. Patil
HOD

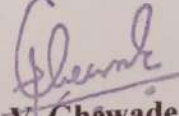
Prof. Dr. D. V. Ghewade
Principal

Dr. V. P. S. S. M.'s
**Padmabhooshan Vasanthaodada Patil Institute
of Technology, Budhgaon Sangli
2022-23**

Certificate



“TOUCHLESS DOORBELL”

This is to Certify that, above project work is carried out in Department of Electronics Engineering by

**Vrushali Subhash Godase
Sharwari Sanjay Gaikwad
Sanika Santosh Mane**

In partial fulfilment of requirement as a part of syllabus by **Dr. Babasaheb Ambedkar Technological University, Lonere** for the course **T. Y. B. Tech.** during the academic year **2022-23** under my guidance

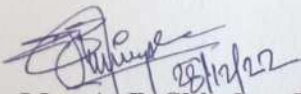
Mr. A. B. Shinde
Guide

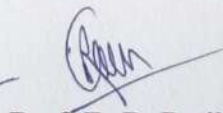
Prof. R. D. Patil
HOD

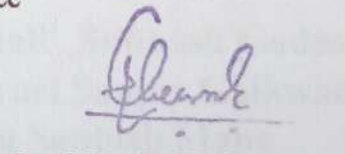
Prof. Dr. D. V. Ghewade
Principal

Dr. V. P. S. S. M.'s
Padmabhooshan Vasantraodada Patil Institute of
Technology, Budhgaon Sangli

Certificate



“HEARTBEAT MONITERING SYSTEM”

This is to Certify that, above project work is carried out in Department of Electronics Engineering by

- 1.NAUMAN SHAIKH
- 2.SHRADDHA DESHMUKH
- 3.GAURI NAKATE

In partial fulfilment of requirement as a part of syllabus by **Dr. Babasaheb Ambedkar Technological University, Lonere** for the course **T. Y. B. Tech.** during the academic year **2022-23** under my guidance.

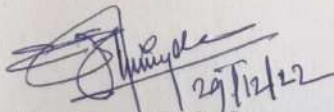
29/12/22
Mr. A. B. Shinde
Guide

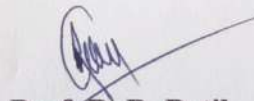
Prof. R. D. Patil
HOD

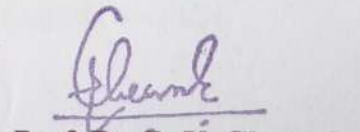
Prof. Dr. D. V. Ghewade
Principal

Dr. V. P. S. S. M.'s
**Padmabhooshan Vasantraodada Patil Institute of
Technology, Budhgaon Sangli**



Certificate

“HOME AUTOMATION USING NODE MCU”

This is to Certify that, above project work is carried out in Department of Electronics Engineering by

Name	PRN No
Shivani Shivling Sankpal	2162691376011
Komal Sandeep Patil	2162691376004
Sakshi Sachin Magdum	2162691376517

In partial fulfilment of requirement as a part of syllabus by **Dr. Babasaheb Ambedkar Technological University, Lonere** for the course **T. Y. B. Tech.** during the academic year **2022-23** under my guidance

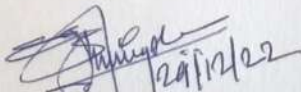
Mr. A. B. Shinde
Guide

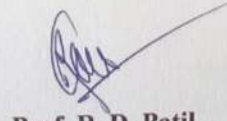
Prof. R. D. Patil
HOD

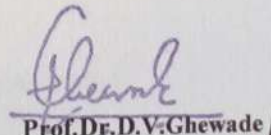
Prof. Dr. D. V. Ghewade
Principal

Dr. V. P. S. S. M.'s

**Padmabhooshan Vasantraodada Patil Institute of
Technology, Budhgaon Sangli**

Certificate



“Automatic Plant Watering System”

This is to Certify that, above project work is carried out in Department of Electronics Engineering by

Suhana Mahamud Magdum

T2162691376545

Uzma Miyalal Khatib

T2162691376504

Supriya Gurappa Mhetre

T2162691376550

In partial fulfilment of requirement as a part of syllabus by **Dr. Babasaheb Ambedkar Technological University, Lonere** for the course **T. Y. B. Tech.** during the academic year **2022-23** under my guidance

Mr. A. B. Shinde
Guide

Prof. R. D. Patil
HOD

Prof. Dr. D. V. Ghewade
Principal

Dr. V. P. S. S. M.'s
Padmabhooshan Vasantraodada Patil Institute of
Technology, Budhgaon Sangli

Certificate



“SMART BLIND STICK”

This is to Certify that, above project work is carried out in Department of Electronics Engineering by

Aniket Sanjay Chavan
Gajanan Govindrao Jadhav
Shivratna Ramchandra Patil

In partial fulfilment of requirement as a part of syllabus by **Dr. Babasaheb Ambedkar Technological University, Lonere** for the course **T. Y. B. Tech.** during the academic year **2022-23** under my guidance

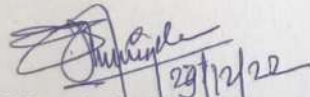
29/12/22

Mr. A. B. Shinde
Guide

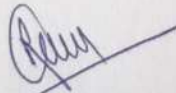

Prof. R. D. Patil
HOD

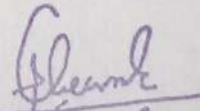

Prof. Dr. D. V. Ghewade
Principal

Dr. V. P. S. S. M.'s
Padmabhooshan Vasantrodada Patil Institute of
Technology, Budhgaon Sangli.

“AUTOMATIC HAND SANITIZER”

Certificate



This is to Certify that, above project work is carried out in Department of Electronics Engineering by

1.	Chavan Yash Ramesh
2.	Kale Rushikesh Dhuloba

In partial fulfilment of requirement as a part of syllabus by **Dr. Babasaheb Ambedkar Technological University, Lonar** for the course **T. Y. B. Tech.** during the academic year **2022-23** under my guidance

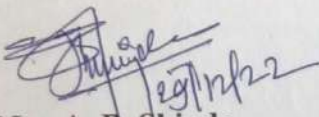
Mr. A. B. Shinde
Guide

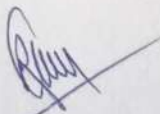
Prof. R. D. Patil
HOD

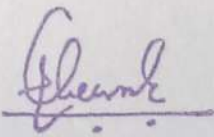
Prof. Dr. D. V. Ghewade
Principal

Dr. V. P. S. S. M.'s
Padmabhooshan Vasantraodada Patil Institute of
Technology, Budhgaon Sangli

Certificate



“Random Password generator using python”

This is to Certify that, above project work is carried out in Department
of Electronics Engineering by

Name	PRN No.
Anjali Pandit Mohite	2162691376506
Aditi Narayan Abhyankar	2162691376530
Vaibhav Prakash Vibhute	2162691376511

In partial fulfilment of requirement as a part of syllabus by
Dr. Babasaheb Ambedkar Technological University, Lonere for the
course **T. Y. B. Tech.** during the academic year **2022-23** under my
guidance

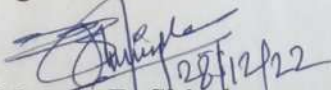
Mr. A. B. Shinde
Guide

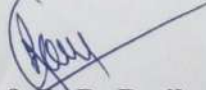
Prof. R. D. Patil
HOD

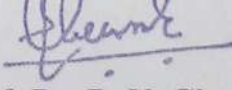
Prof. Dr. D. V. Ghewade
Principal

Certificate



"CNC PCB PLOTTER MACHINE"

This is to Certify that, above project work is carried out in Department of Electronics Engineering by

- 1.HARSHAWARDHAN SAWANT
- 2.PRAJYOT SATHAYE
- 3.DHIRAJ PAWAR

In partial fulfilment of requirement as a part of syllabus by **Dr. Babasaheb Ambedkar Technological University, Lonere** for the course **T. Y. B. Tech.** during the academic year **2022-23** under my guidance.

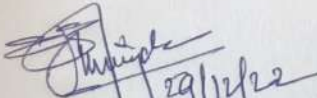
29/12/22
Mr. A. B. Shinde
Guide

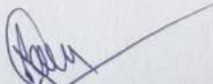
Prof. R. D. Patil
HOD

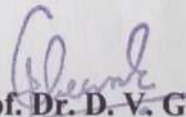
Prof. Dr. D. V. Ghewade
Principal

Dr. V. P. S. S. M.'s
Padmabhooshan Vasantraodada Patil Institute of
Technology, Budhgaon Sangli

Certificate



“Reverse car parking sensor using ultra sensor and arduino uno”

This is to Certify that, above project work is carried out in Department of
Electronics Engineering by

Pratiksha Suresh Pawar
Shweta Shivaji Patil
Shraddha Ravaso chougule

In partial fulfilment of requirement as a part of syllabus by **Dr. Babasaheb
Ambedkar Technological University, Lonere** for the course **T. Y. B. Tech.**
during the academic year **2022-23** under my guidance.

Mr. A. B. Shinde
Guide

Prof. R. D. Patil
HOD

Prof. Dr. D. V. Ghewade
Principal

Dr. V. P. S. S. M.'s
Padmabhooshan Vasanthaodada Patil Institute of
Technology, Budhgaon Sangli

Certificate



“Variable Timer Switch”

This is to Certify that, above project work is carried out in Department
of Electronics Engineering by

Aditya Sudhir Waghmare
Om Milind Dhamanage
Pramod Abhay Alate

In partial fulfilment of requirement as a part of syllabus by
Dr. Babasaheb Ambedkar Technological University, Lonere for the
course **T. Y. B. Tech.** during the academic year **2022-23** under my
guidance

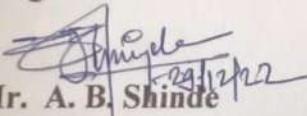
Mr. A. B. Shinde
Guide

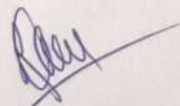
Prof. R. D. Patil
HOD

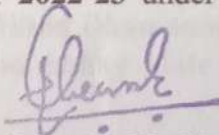
Prof. Dr. D. V. Ghewade
Principal

Dr. V. P. S. S. M.'s
Padmabhooshan Vasantrodada Patil Institute of
Technology, Budhgaon Sangli



Certificate

“Product Counting Device Using Aurdino”

This is to Certify that, above project work is carried out in Department of Electronics Engineering by

Name	PRN No
Shrushti Basavraj Pachhapure	2062691376018
Divya Arun Irale	2162691376518
Aishwarya Samptrao Mohite	2162691376539

In partial fulfilment of requirement as a part of syllabus by **Dr. Babasaheb Ambedkar Technological University, Lonere** for the course **T. Y. B. Tech.** during the academic year **2022-23** under my guidance

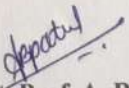
Asst. Prof. A. B. Patil
Guide

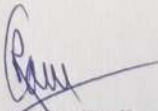
Prof. R. D. Patil
HOD

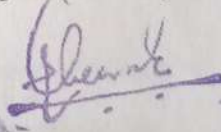
Prof. Dr. D. V. Ghewade
Principal

2022-23

Dr. V. P. S. S. M.'s

Padmabhooshan Vasantrodada Patil Institute of
Technology, Budhgaon Sangli

Certificate



“AUTOMATIC RAIN SENSING CAR WIPER”

This is to Certify that, above project work is carried out in Department
of Electronics Engineering by

JAINAB FIROJ PINJARI.

PRANALI VISHWAS DEVKULE.

In partial fulfilment of requirement as a part of syllabus by
Dr. Babasaheb Ambedkar Technological University, Lonere for the
course **T. Y. B. Tech.** during the academic year **2022-23** under my
guidance

A. B. Patil
Asst.Prof. A. B. Patil
Guide

R. D. Patil
Prof. R. D. Patil
HOD

D. V. Ghewade
Prof. Dr. D. V. Ghewade
Principal

2022-23

Dr. V. P. S. S. M.'s

Padmabhooshan Vasanttraodada Patil Institute of Technology,
Budhgaon Sangli

Certificate



“LINE FOLLOWING ROBOT”

This is to Certify that, above project work is carried out in Department of Electronics Engineering by

Snehal Mali
Pallavi Manugade
Sneha Shinde

In partial fulfilment of requirement as a part of syllabus by Dr. Babasaheb Ambedkar Technological University, Lonere for the course T. Y. B. Tech. during the academic year 2022-23 under my guidance

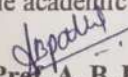
Asst. Prof. A. B. Patil
Guide

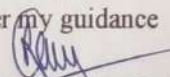
Prof. R. D. Patil
HOD

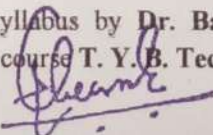
Prof. Dr. D. V. Ghewade
Principal

Dr. V. P. S. S. M.'s
Padmabhooshan Vasantraodada Patil Institute of
Technology, Budhgaon Sangli

Certificate



"OBSTACLE AVOIDING ROBOT"

This is to Certify that, above project work is carried out in Department
of Electronics Engineering by

Siddharth.B.Kamble
Parshuram.B.Mokashi
Akash.H.Kolekar
Aditya.R.Patil

In partial fulfilment of requirement as a part of syllabus by **Dr. Babasaheb Ambedkar Technological University, Lonere** for the course **T. Y. B. Tech.** during the academic year **2022-23** under my guidance

Asst. Prof. Ashwini Patil
Guide

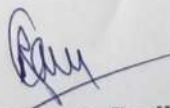
Prof. R. D. Patil
HOD

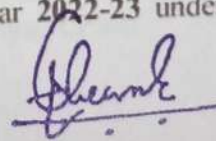
Prof. Dr. D. V. Ghewade
Principal

Dr. V. P. S. S. M.'s
**Padmabhooshan Vasantraodada Patil Institute of
Technology, Budhgaon Sangli**



Certificate

“Bluetooth based home automation”

This is to Certify that, above project work is carried out in Department of Electronics Engineering by

**Shruti Dayanand Tasgaonkar
Sarfaraj Mustak Pathan.**

In partial fulfilment of requirement as a part of syllabus **Dr. Babasaheb Ambedkar Technological University, Lonere** for the course **T. Y. B. Tech.** during the academic year **2022-23** under my guidance

Asst. prof. A.B.Patil
Guide

Prof. R. D. Patil
HOD

Prof. Dr. D. V. Ghewade
Principal

Dr. V. P. S. S. M.'s
Padmabhooshan Vasantodada Patil Institute of
Technology, Budhgaon Sangli

Certificate



“Parking Sensor Using Arduino”

This is to Certify that, above project work is carried out in Department of Electronics Engineering by

Abhijeet Hubale
Shubham Kadam
Tejas Navale

In partial fulfilment of requirement as a part of syllabus by **Dr. Babasaheb Ambedkar Technological University, Lonere** for the course **T. Y. B. Tech.** during the academic year **2022-23** under my guidance

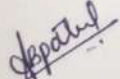
Assjt. Prof. A.B. Patil
Guide

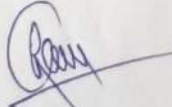
Prof. R. D. Patil
HOD

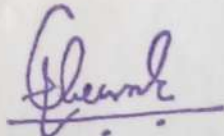
Prof. Dr. D. V. Ghewade
Principal

Dr. V. P. S. S. M.'s

**Padmabhooshan Vasantraodada Patil Institute of
Technology, Budhgaon Sangli**



Certificate

“Fingerprint Door Lock System Using Arduino”

This is to Certify that, above project work is carried out in Department of Electronics Engineering by

Sr.no	Name
1.	Pranjali Dattatray Gavade
2.	Gitanjalee Sitaram Gurav
3.	Vidya Ramkrishna Patil
4.	Monika Shrikant Mane

In partial fulfillment of requirement as a part of syllabus by **Dr. Babasaheb Ambedkar Technological University, Lonere** for the course **T. Y. B. Tech.** during the academic year **2022-23** under my guidance

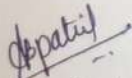
Asst. Prof. A. B. Patil
Guide

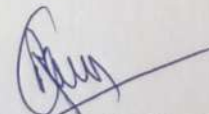
Prof. R. D. Patil
HOD

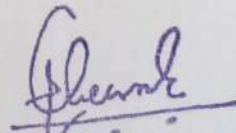
Prof. Dr. D. V. Ghewade
Principal

Dr. V. P. S. S. M.'s
**Padmabhooshan Vasantraodada Patil Institute of
Technology, Budhgaon Sangli**

Certificate



“WIFI CONTROL ROBOTCAR”

This is to Certify that, above project work is carried out in Department of Electronics Engineering by

**Nilesh Nayan kulkarni
Prathamesh Sunil Parit
Akshay pandurang Pawar
Shounak Shrikant Shirgurkar**

In partial fulfilment of requirement as a part of syllabus by **Dr. Babasaheb Ambedkar Technological University, Lonere** for the course **T. Y. B. Tech.** during the academic year **2022-23** under my guidance

Asst. Prof. A.B. Patil

Guide

Prof. R. D. Patil

HOD

Prof. Dr. D. V. Ghewade

Principal

Dr. V. P. S. S. M.'s

PadmabhooshanVasatraodadaPatil Institute of
Technology, Budhgaon Sangli

Certificate





“Arduino Human Following Robot”

This is to Certify that, above project work is carried out in Department of Electronics Engineering by

- | | |
|-----------------------------------|----------------|
| 1. Tanmay Pradip Mankani | T2062691376015 |
| 2. Harshwardhan Yashwant Chougale | T2162691376532 |
| 3. Pruthviraj Chandrakant Mane | T2162691376521 |

In partial fulfilment of requirement as a part of syllabus by **Dr. Babasaheb Ambedkar Technological University, Lonere** for the course **T. Y. B. Tech.** during the academic year **2022-23** under my guidance

Asst. Prof. A. B. Patil
Guide

Prof. R. D. Patil
HOD

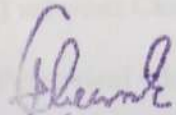
Prof. Dr. D. V. Ghewade
Principal

CERTIFICATE

Vasatraodada Patil Shetkari Shikshan Mandal's

Padmabhooshan Vasatraodada Patil Institute of Technology



“RFID Based Attendance System”

Name	Roll No
Rutuja Patil	4112
Vaishnavi Chougule	4115
Varad Chivate	41120

Submitted By

In partial fulfilment of the requirements as a part of the syllabus by Dr. Babasaheb Ambedkar Technological University Lonere for the course **Mega Project** at **B.Tech** during the academic year **2022-2023**.

Guide

HOD

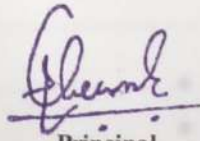
Principal

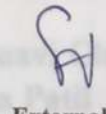
External

Dr. k.k Pandyaji

Prof. R.D. Patil

Prof. D.V. Ghevade

Date:

Place:

CERTIFICATE

Padmbhooshan Vasantraodada Patil Institute Of Technology Budhgaon
Sangli



Prediction Of Student Performance By Using Machine Learning
Algorithms

Submitted By

Name	Roll No
Arshiya Ayub Shaikh	4101
Tushar Vasant Vhanmane	4104
Vidya Raju Sagare	4105

In partial fulfilment of the requirements as a part of the syllabus by Dr. Babasaheb
Ambedkar Technological university lonere for the course Mega project at B.Tech during the
academic year 2022-23

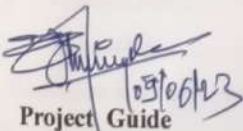
Project Guide

Prof. A. B. Shinde

HOD

Prof. R. D. Patil

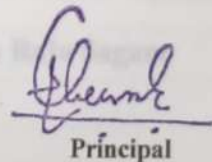
Principal

Prof. D. V. Ghevade

Date: 09/06/2023

Place:

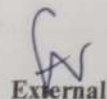
External

CERTIFICATE**PADMABHOOSHAN VASANTRAODADA PATIL****INSTITUTE OF TECHNOLOGY, BUDHGAON**

“IoT Assisted Water Quality Analysis & Alerting System”

Submitted By

Name	Roll No
Kosuri Rohansai	4106
Mahadik Aarti	4107
Dongare Sakshi	4113

In partial fulfilment of the requirements as a part of the syllabus by **Dr. Babasaheb Ambedkar Technological University, Lonere** for the course **Mega Project at B. Tech** during the academic year **2022-2023**.

Guide

Dr. K.P. Paradeshi

HOD

Prof. R. D. Patil

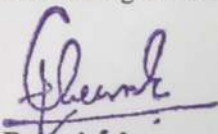
Principal

Prof. D. V. Ghewade

Date:-

Place:-

Electronics Department, PVPIT, Budhgaon

External

CERTIFICATE
PADMABHOOSHAN VASANTRAODADA PATIL
INSTITUTE OF TECHNOLOGY, BUDHGAON.



“Multipurpose Agriculture Rover”

Submitted By

NAME	Roll No
Patil Pratik Pandurang	4117
Linge Milind Hanmant	4119
Patil Aishwarya Payagonda	4110
Ubale Pradnya Arvind	4122

In partial fulfilment of the requirements as a part of the syllabus by **Dr. Babasaheb Ambedkar Technological University, Lonere** for the course **Mega Project** at B. Tech during the academic year **2022-2023**.



Guide

Miss.A.S.Bhandare

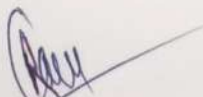
Date:-

HOD

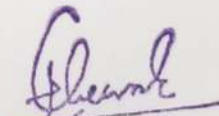
Prof. R. D. Patil

Principal

Prof. D. V. Ghevade

External

CERTIFICATE

**PADMABHOOSHAN VASANTRAODADA PATIL
INSTITUTE OF TECHNOLOGY, BUDHGAON.**



"SMART PARKING TOWER"

Submitted By

Name	Roll No
Nadaf Shagufta	4103
Rajput Shivraj	4118
Shaikh Imtiyaj	4114

In partial fulfilment of the requirements as a part of the syllabus by **Dr. Babasaheb Ambedkar Technological University, Lonere** for the course **Mega Project** at **B. Tech** during the academic year **2022-2023**.

Guide

Mr. V.J. Tamboli

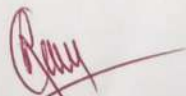
HOD

Prof. R. D. Patil

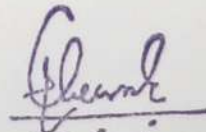
Principal

Prof. D. V. Ghevade

Date:- 12/06/2023

Place:- Budhgaon.

External

Electronics Department, PVPIT, Budhgaon

**PADMABHOOSHAN VASANTRAODADA PATIL INSTITUTE
OF TECHNOLOGY, BUDHAGAON, SANGLI.**

DEPARTMENT OF CIVIL ENGINEERING



CERTIFICATE

This is to certify that the B. Tech Project Report entitled "Sign Language Recognition Using Python and Open-cv"

Submitted by :

Name	Roll no.	PRN
Janaki Sharad Jambhalikar	4108	1962691376015
Sandili Bandu Bhosale	4109	2062691376002
Nisha Balasaheb Patil	4111	2062691376005

to the Department of Electronics Engineering of Padmabhooshan Vasanttraodada Patil Institute Of Technology, Budhagaon, Sangli in partial fulfilment for the award of Degree of **B.Tech (Electronics Engineering)**. This project report is a record of the project work carried out by them under my supervision during the academic year 2022- 2023.

Date : 22/7/2023

Place : Sangli

External
Examiner

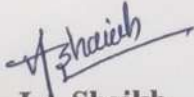
Dr. J.A. Shaikh
Guide

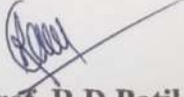
Prof. R.D. Patil
Head of Department

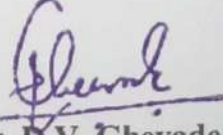
Dr. D.V. Ghevade
Principal

CERTIFICATE
PADMABHOOSHAN VASANTRAODADA
PATIL INSTITUTE OF
TECHNOLOGY, BUDHGAON.



“VERTICAL FARMING”

Submitted By

Name	Roll No
Prajval V. Shinde	4116
Harshad V.Chavan	4121
Prathamesh S. Kamble	4102

In partial fulfilment of the requirements as a part of the syllabus by **Dr. Babasaheb Ambedkar Technological University, Lonere** for the course **Mega Project at B. Tech** during the academic year **2022-2023**.

Guide

Prof.R.D.Patil

HOD

Prof.R.D.Patil

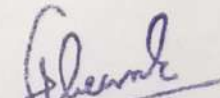
Principal

Prof.D.V. Ghevade

Date:-



"DON'T THINK OF COST. THINK OF VALUE"

S.P. ELECTRICAL, SANGLI

Dhamani Chowk, 100 Ft. Road, Sangli- 416 416
Email: spelectrical2815@gmail.com

Mr. Padmbhushan S. Patil
Mob: 9922445655, 8329394922

Ref. No.

Date:

TO WHOMEVER IT MAY CONCERN

This is to certify that Mr. Piyush Pramod Vankhade was working with has from 26 June to 10 July & 23 July to 6 August 2023 in S.P. Electrical, Sangli

Has completed industrial trainee Engineer.

He was found sincere & hardworking during this tenure.

We wish him all the best for his future endeavors.

Thanking you,

Yours truly.

For S.P Electrical, Sangli

Director 
Padmbhushan S. Patil



Principal
Padmbhushan Vasantraodade Patil
Institute of Technology
BUDHGAON - 416 304

Date: 30th June 2023

Principal
Dr. Amabhoshan Wasantrao
Institute of Technology
BUDHGAON - 416 304

TO WHOMSOEVER IT MAY CONCERN,

This is to certify that **Mr. Irfan Musa Shaikh** studying Bachelors in Electrical Engineering at PVPIT Budhgaon, Sangli has undergone **Electrical Maintenance training** at **Doctors Angel Office Address 393, Somwar peth Madhavnagar 416406** from 1st June to 30th June 2023.

The training programme covered the following topics:

- Basics of Industrial Electricity maintenance
- Electric Motors: Understanding & Troubleshooting
- Installation of equipment to inspecting and diagnosing any faults with the equipment to Servicing and repairing faulty electrical equipment

We congratulate **Mr. Irfan Musa Shaikh** for his/her dedication and hard work during the training programme and wish him/her all the best for his/her future endeavours.

Thanking You,



Doctor's Angel.

CERTIFICATE OF APPRECIATION

SGP Instruments

This is to certify that Mr. Atharv Dhondiram Nalwade has completed the preserved course of basic training in our company during period from 8th June 2023 to 20th July 2023 in the designed trade of Electrical Equipments & testing.

We wish her/his success in all her/his future carrier.



Harshal Phalle

Mr. Harshal Phalle

FOR. SGP Instruments

Sangli

Principal
Pamabhoshan Vasantraodare
Institute of Technology
BUDHGAON - 416 304

Place : Sangli

harshalphalle@gmail.com

Duration of training (Internship) :

The duration of my training (internship) is from April 2023 to June 2023. This is total 2 months of internship where everyday there was hour of training.

Q.T Achievement (Certificate/Award) :

On 23th June , 2023, I received a completion certificate from Naresh technologies attesting to my completion of the internship.



Principal
Padmabhooshan Vasanttraodade Patil
Institute of Technology
BUDHGAON - 416 304

CERTIFICATE:

ASE

M/s. Anand Sagar Electrical's

PCC, MCC, PLC,VFD BUSDUCT etc. types of Electrical Panel's Manufacturer, Govt. Licence Electrical Contractor M.C.NO:23769 L T & H T Line Erection & Substation, All Industries Electrical Project Works. Plot No: P86, M.I.D.C., Kupwad, 416424 Dist. Solapur (M.S) Fax: 0233/2646828_0233/3206184, Mob No: 09423872557_09422042030_9767582290E-mail. anandsagarfe@gmail.com.anandsagarfe@rediffmail.com

DATE-03/09/2022

INTERNSHIP CERTIFICATE

This is to certify that **Ms.Vaishnavi Manik Bhosale** has successfully completed 1 MONTH (01/08/2022 To 01/09/2022) Internship program at "Anand Sagar Electricals,Kupwad".

During his stay we observe she obedient, honest, hardworking and dedicated employee with professional attitude and very good job knowledge.We have no objection to allow she in any better position and have no liabilities in our company.



Sincerely,
For Anand Sagar Electricals,
Kupwad.

A handwritten signature in black ink, appearing to read "Sujata".

Authorized signatory.

Principal
Padmanabhooshan Vasanttraodade Patil
Institute of Technology
BUDHGAON - 416 304

CERTIFICATE



Pantech e Learning
DIGITAL LEARNING SIMPLIFIED

CERTIFICATE NO

PEL_EVMC_PART_382

PANTECH SOLUTIONS
Technology Beyond The Dreams

**CERTIFICATE
OF PARTICIPATION**

NAME ASHITOSH RAMESH AWALKAR

COLLEGE P.V.P.I.T. BUDHGAON ,SANGLI

has Successfully Completed
30 Days Masterclass on Electric Vehicle Design

at Pantech e Learning Pvt Ltd, Chennai

From 28.06.2023 to 28.07.2023

Sh. K. K. Thakur
CHAIRMAN
IETE, Ranchi

M. Malaiyappan
Director
Pantech e learning

Padma Bhushan Vasuntraodade Pao
Institute of Technology
BUDHGAON - 416 304

CERTIFICATE



Pantech e Learning
DIGITAL LEARNING SIMPLIFIED

CERTIFICATE NO PEL_EVMC_PART_392

PANTECH SOLUTIONS
Technology Beyond The Screen

CERTIFICATE
OF PARTICIPATION

NAME PRANAV SANJAY ROKADE
COLLEGE P.V.P.I.T. BUDHGAON ,SANGLI

has Successfully Completed
30 Days Masterclass on Electric Vehicle Design
at Pantech e Learning Pvt Ltd, Chennai
From 28.06.2023 to 28.07.2023

Sh. K. K. Thakur
CHAIRMAN
IETE, Ranchi

M. Malaiyappan
Director
Pantech e learning

Principal
Padmashooshan Vasantnraodade Pat
Institute of Technology
BUDHGAON - 416 304

CERTIFICATE



Pantech e Learning
DIGITAL LEARNING SOLUTIONS

CERTIFICATE NO

PEL_EVMC_PART_382

PANTECH SOLUTIONS
Technology Beyond The Dream

CERTIFICATE
OF PARTICIPATION

NAME SARVESH SANJAY CHAVAN

COLLEGE P.V.P.I.T.BUDHGAON ,SANGLI

has Successfully Completed

30 Days Masterclass on Electric Vehicle Design

at Pantech e Learning Pvt Ltd, Chennai

From 28.06.2023 to 28.07.2023

Sh. K. K. Thakur
CHAIRMAN
IETE, Ranchi

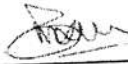
M. Malaiyappan
Director
Pantech e learning

Principal
Padmashooban Vasantraodade Pw.
Institute of Technology
BUDHGAON - 416 304

CERTIFICATE



Pantech e Learning
DIGITAL LEARNING SIMPLIFIED

CERTIFICATE NO PEL_EVMC_PART_382

PANTECH SOLUTIONS
Technology Beyond The Screen

**CERTIFICATE
OF PARTICIPATION**

NAME AVDHUT ANNASO BEDAGE
COLLEGE P.V.P.I.T.BUDHGAON ,SANGLI

has Successfully Completed
30 Days Masterclass on Electric Vehicle Design

at Pantech e Learning Pvt Ltd, Chennai

From 28.06.2023 to 28.07.2023

Sh. K. K. Thakur
CHAIRMAN
IETE, Ranchi

M.Malaiyappan
Director
Pantech e learning

Padmanabhooshan Vasantrao Patil
Institute of Technology
BUDHGAON - 416 304

Er.Akshay Dilip koli
Mob: 9637603838
8275611300

M C NO.2163100012 28112019

M/S. A. K. POWER LINES

GOVT. LICENSED ELECTRICAL CONTRACTOR

A/P : Uchagaon Tal: Karveer, Dist :Kolhapur. Email : akpowerlines@gmail.com

Date:- 02Jan2023

INTERNSHIP CERTIFICATE

**The H.O.D – Electrical Department
P.V.P. Institute of technology
Budhgoan.**

This is to certify that. **Mr. Yash Gajanan Mane Of B. Tech. Final year in Electrical Engineering** from the College **Padmabhushan Vasantro Dada Patil Institute of Technology, Budhgaon** has completed Internship in **A. K. Power Lines, Kolhapur** in the Period of **2 January 2023 to 2 February 2023**. According to this he completed **5 Weeks** Internship.

In the Internship period we found him a sincere, honest, *hardworking*, dedicated trainee with a professional attitude and very *good job knowledge*. In this duration we gave him training of all types of *Installation of Transformers & Transmission of LT Line*. We found him work satisfactory because of his sincerity, dedication and hard work.

We have found him to be a self-starter who is new invention view. We wish him all the best and success in future career.

Yours Faithful

A.K. Power Lines

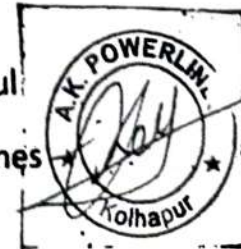

Principal
Padmabhushan Vasantro Dada Patil
Institute of Technology
BUDHGAON - 416 304



M/S. "Khare Ele-Trans"

MFG OF ALL TYPE OF TRANSFORMER

CERTIFICATE

This is certify that, MR. SUHAS GAUTAM KAMBALE of T.Y.B.TECH (Electrical) from Padmbhooshan Vasantrodada Patil Institute Of Technology , Budhgaon, Dist.Sangli has visited our factory from 15/05/2023 to 15/06/2023 for vocational in plant training.

During his training period, he found regular and sincere

This certificate issued on his request.

Date : 15/06/2023

Place: Tasgaon



Authorised Signatory

For khare elec-trans

Tasgaon Ind., Estate Co. Op. Society, Tasgaon - 416 312 Dist. Sangli (Maharashtra, India) (02346)
(0.) 250336, 250484, E-mail : Khare.shripad114@gmail.com, web site : www.khareelectrans.co.in



M/S. "Khare Ele-Trans"

MFG OF ALL TYPE OF TRANSFORMER

CERTIFICATE

This is certify that, **MR. SURAJ SHANKAR MHALKAR** student of T.Y.B.TECH (Electrical) from **Padmabhooshan Vasantraodada Patil Institute Of Technology , Budhgaon, Dist.Sangli** has visited our factory from **15/05/2023 to 15/06/2023** for vocational in plant training.

During his training period, he found regular and sincere

This certificate issued on his request.

Date : 15/06/2023

Place: Tasgaon



Authorised Signatory

For khare elec-trans

*Tasgaon Ind., Estate Co. Op. Society, Tasgaon - 416 312 Dist. Sangli (Maharashtra, India) (02346)
(0.) 250336, 250484, E-mail : Khare.shripad114@gmail.com, web site : www.khareelectrans.co.in*

Padmabhooshan Vasant
Institute of Technology
BUDHGAON - 416 304

M/S. "Khare Ele- Trans"

MFG OF ALL TYPE OF TRANSFORMER

CERTIFICATE

This is certify that, **MR. SANKET MAHADEV PANSE** student of **T.Y.B.TECH (Electrical)** from **Padmabhooshan Vasantraodada Patil Institute Of Technology , Budhgaon, Dist.Sangli** has visited our factory from **15/05/2023 to 15/06/2023** for vocational in plant training.

During his training period, he found regular and sincere

This certificate issued on his request.

Date : 15/06/2023

Place: Tasgaon



Authorised Signatory

For khare elec-trans

*Tasgaon Ind., Estate Co. Op. Society, Tasgaon - 416 312 Dist. Sangli (Maharashtra, India) (02346)
(0.) 250336, 250484, E-mail : Khare.shripad114@gmail.com, web site : www.khareelectrans.co.in*

Principal
Padmabhooshan Vasantraodada Patil
Institute of Technology
BUDHGAON - 416 304

M/S. 16horc Élec - Trans
MFG OF ALL TYPE OF TRANSFORMERS

CERTIFICATE

This is to certify that, MISS. AVANTIKA VITTHAL JADHAV, student
Of T.Y.B.Tech (Electrical) from the Padmabhushan Dr. Vasantdada Patil Institute of
Technology, Budhgaon, Dist. Sangli has visited our factory from 15/05/2023 to
15/06/2023 for Vocational in plant Training.

During her training period she found regular & sincere.

This certificate issued on her request.

Date: 15/06/2023

Place - Tasgaon

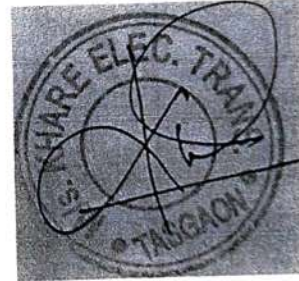

Authorized Signatory
For Khare Elec-

TransPlot No. 13/18,
Tasgaon Ind., Estate Co.

Op. Society, Tasgaon -
416 312 Dist. Sangli

(Maharashtra, India)

02346 250336, 250484

(Fax) 250342, E-mail :

Khare.shripad114@gmai

l.com, web site :

www.khareelectrarv

Principal
Padmabhushan Vasantrao
Institute of Technology
BUDHGAON - 416 304



M/S. "Khare Elec-Trans"

MFG OF ALL TYPE OF TRANSFORMER

CERTIFICATE

This is certify that, MISS.SHRUTIKA SANJAY BAMANKAR student of T.Y.B.TECH (Electrical) from Padmabhooshan Vasandraodada Patil Institute Of Technology , Budhgaon, Dist.Sangli has visited our factory from 15/05/2023 to 15/06/2023 for vocational in plant training.

During her training period, she found regular and sincere

This certificate issued on her request.

Date : 15/06/2023

Place: Tasgaon



Authorised Signatory

For khare elec-trans

Tasgaon Ind., Estate Co. Op. Society, Tasgaon - 416 312 Dist. Sangli (Maharashtra, India) (02346)
(0.) 250336, 250484, E-mail : Khare.shripad114@gmail.com, web site : www.khareelectrans.co.in

Padmabhooshan Vasandraodada Patil
Institute of Technology
BUDHGAON - 416 304

N.S.D.C



**INDIA
INTERNATIONAL
SKILL CENTRE**



Skill India
कौशल भारत - कुशल भारत

APPROVED TRAINING PARTNER



N.S.D.C

**National
Skill Development
Corporation**

Transforming the skill landscape

DHANUSH ENGGSERVICES INDIA Pvt., Ltd.,

H.No:6-3-788/A/9, 2nd Floor, Durga Nagar Colony, Ameerpet, Hyderabad, Telangana, India - 500016,

Email: info@meptrainings.com PH: 040-40064413.

CERTIFICATE OF COMPLETION

This Certificate is hereby bestowed upon

BELKAR GIRISH GAJANAN

for the Completion of **ELECTRICAL DESIGN AND DRAFTING**

Training Successfully Conducted From **21.09.2022** To **05.11.2022**

Registration No : 210922-001-EDD-C-02

Date of Issue : 12.11.2022



DHANUSH



2004

www.mepcentre.com

Medhar
**CHAKRADHAR MAJETY
DIRECTOR**

Principal
Institute of Technology
Pragathi Institute of Technology
18/3/2022



CERTIFICATE

This to certify that Miss.Pradnya Ravsaheb Pawar Student of department of electrical And Computer Engineering Of Padmabhooshan Vasantvadada Patil Institute Of Technology,Sangli.

She has completed industrial training in our company for the period 08.06.2023 to 20.07.2023 during the training various maintenance work repairing motors,transformers generators and electronic controller on machine tool and industrial robots.various maintenance work in substation yard and operation of high pressure molding line.

During the tensure of Her training she were quite industrious and dependable with enthusiastic attitude of learning with good perception and good performance.

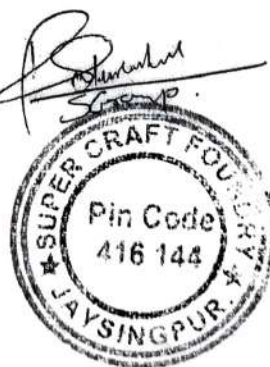

Principal
Padmabhooshan Vasantvadade Patil
Institute of Technology
BUDHGAON 416 227

Swift Enterprise Pvt. Ltd.

103/1,2,3, L. K. Akiwate Ind. Estate, JAYSINGPUR-416 144,
Dist : Kolhapur, Maharashtra, INDIA. • Tel : +91 8669958605
Email : sepimr@scfsepl.com

Raising the benchmark among

CERTIFICATE OF APPRECIATION

SGP Instruments

This is to certify that Mr. Sagar Pramod Kole has completed the preserved course of basic training in our company during period from 8th June 2023 to 20th July 2023 in the designed trade of Electrical Equipments & testing.

We wish her/his success in all her/his future carrier.



Place : Sangli

harshalphalle@gmail.com



Harshal Phalle
Mr. Harshal Phalle
FOR SGP Instruments
Sangli



SHRI RAMPRASAD ENGINEERING WORKS.

Plot No. 71,1st phase, sector B, Shri Laxmi Ind. Estate Hatkanangle -416109

Com. S.S.I. No. 27/034/11/00562

Email:- pravinsankpal21@gamil.com

Ref. No.

Date:

TO WHOMEVER IT MAY CONCERN

This is to certify that mr. Omkar Prakash Jambhale was working with has from 26 June 2023 to 10 July 2023 & 23 July 2023 to 6 August 2023 in shri ramprasad engineering works, hatkanangle.

Has completed industrial trainee engineer.

He was found sincere & hard working during this tenure.

We wish him all the best for his future endeavors.

Thanking you,

Your truly.



For sriram prasad Engineering works
Director -Pravin sankpal

Principal
Padmabhooshan Vasantraodada Patil
Institute of Technology
BUDHGAON - 416 304

- MFRS. OF POWER & DISTRIBUTION TRANSFORMERS.
- MOBILE ULTRA HI-VACUUM FILTRATION PLANT.



AN ISO : 9001-2008 COMPANY

**POWER
ENGINEERS**

TO WHOM SO EVER IT MAY CONCERN

Ref No: RIT/Elect/1860/2022

Date: 01.07.2023

This is to certify that, *Pratik Parshuram Suryavanshi* student of Class (TY)
B. Tech in Electrical Engg. **P.V.P institute of technology budhgaon** has
undergone Industrial training program as a part of syllabus from 01.06.2023 to 01.07.2023

In this program he studied following basics of Transformer Manufacturing Industry:-

1. Introduction to raw material
2. Manufacturing process
3. Routine Testing of 3-Phase Distribution Transformer

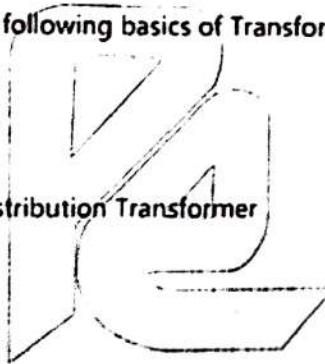

FOR POWER ENGINEERS

AUTORISED SIGNATORY

Principal
Pradmanbhooshan Vasantrao Jadhav Patil
Institute of Technology
BUDHGAON - 416 304



Vardhaman Services

GOVT. REGISTERED ELECTRICAL CONTRACTOR & ENGINEER
HT/LT, DTC Erection Work, Industrial & Residential Wiring,
Load Balancing, Supply of Wiring Material, Roof Top Solar System & Products
CCTV System, Alarm System, Home Automation, Labour Supply &
All types of Corporate Services

M.C. No.: 38037

CERTIFICATE

This is to certify that **Mr. Shivraj Jagnath Topkar**, Student Of Padmabhooshan Vasantrodada Patil Institute of Technology Budhgaon (B.E Electrical Engineering –II year) has completed industrial training as a Trainee Engineer in our firm from 18/01/2023 to 18/02/2023. During his stay we observe him Obedient, Honest & Dedicated with his assignment.

We hope & pray bright & good speed in his future life.

Date-18/02/2023

M/S Vardhaman Services



Principal
Padmabhooshan Vasantrodada Patil
Institute of Technology
BUDHGAON - 416 304

TO WHOM SO EVER IT MAY CONCERN

Ref No: Elect/1860/2022

Date: 01.07.2023

This is to certify that, **Sachin Namdev Patil** student of Class (TY)
B. Tech in Electrical Engg. **P.V.P institute of technology budhgaon** has
undergone Industrial training program as a part of syllabus from **01.06.2023** to **01.07.2023**

In this program he studied following basics of Transformer Manufacturing Industry:-

1. Introduction to raw material
2. Manufacturing process
3. Routine Testing of 3-Phase Distribution Transformer

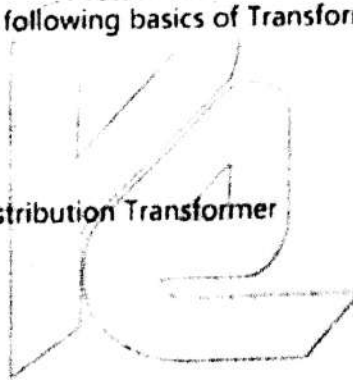

FOR POWER ENGINEERS

AUTHORISED SIGNATORY

Principal
Padmaheoshah Vasantraodade Patil
Institute of Technology
BUDHGAON - 416 304



TO WHOM SO EVER IT MAY CONCERN

Ref No: Elect/1860/2022

Date: 01.07.2023

This is to certify that, **Muskan Javed Attar** student of Class (**TY**)
B. Tech in Electrical Engg. **P.V.P institute of technology budhgaon** has
undergone Industrial training program as a part of syllabus from **01.06.2023** to **01.07.2023**

In this program he studied following basics of Transformer Manufacturing Industry:-

1. Introduction to raw material
2. Manufacturing process
3. Routine Testing of 3-Phase Distribution Transformer

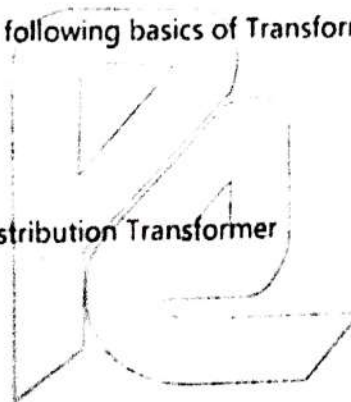

FOR POWER ENGINEERS

AUTORISED SIGNATORY

Principal
Padmanabhooshan Vasanthakumari Pasi
Institute of Technology
BUDHGAON - 416 303

Chaitanya Electrocontrols

A]27Ekdant Appartment, Behind Katraj Dairy, Katraj, Pune — 41 1 046

GST No. 27 ABWPG0598CIZE Mob. No. , 9730601814

CERTIFICATE FOR TRAINING

(To whom so ever it may concern)

This is certify that Mr. Swapnil Chandrakant Kadam student of Padmabhooshan Vasatraodada Patil Institute of Technology, Budhgaon has satisfactorily completed his training in our organization Chaitanya Electrocontrols, Pune for a period of 30 Days from 01/06/2023 to 01/07/2023.

During this period he got hands on site experience for Testing, servicing & Maintenance of lead acid stationary battery at EHV S/s. We wish him a good carrier ahead.

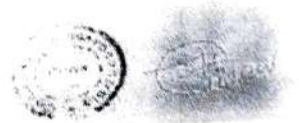

Authorized Signature

Principal
Padmabhooshan Vasatraodade Patil
Institute of Technology
BUDHGAON - 416 304

Chaitanya Electrocontrols

A]27Ekdant Apartment, Behind Katraj Dairy, Katraj, Pune — 41 1 046

GST No. 27 ABWPG0598CIZE Mob. No. , 9730601814

CERTIFICATE FOR TRAINING.

(To whom so ever it may concern)

This is certify that Mr. Akash Ganapati Dudhal student of Padmabhooshan Vasanthaodada Patil Institute of Technology, Budhgaon has satisfactorily completed his training in our organization Chaitanya Electrocontrols, Pune for a period of 30 Days from 01/06/2023 to 01/07/2023.

During this period he got hands on site experience for Testing, servicing & Maintenance of lead acid stationary battery at EHV S/s
We wish him a good carrier ahead.

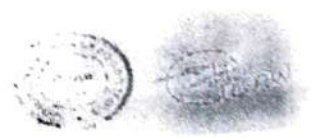

Authorized Signature

Principal
Padmabhooshan Vasanthaodada Patil
Institute of Technology
BUDHGAON - 416 304

Chaitanya Electrocontrols

A]27Ekdant Appartment, Behind Katraj Dairy, Katraj, Pune — 41 1 046

GST No. 27 ABWPG0598CIZE Mob. No. , 9730601814

CERTIFICATE FOR TRAINING

(To whom so ever it may concern)

This is certify that Mr. Satyajit Prakash Thorat student of Padmabhooshan Vasandraodada Patil Institute of Technology, Budhgaon has satisfactorily completed his training in our organization Chaitanya Electrocontrols, Pune for a period of 30 Days from 01/06/2023 to 01/07/2023.

During this period he got hands on site experience for Testing, servicing & Maintenance of lead acid stationary battery at EHV S/s. We wish him a good carrier ahead.



Authorized Signature

Principal
Padmabhooshan Vasandraodada Patil
Institute of Technology
Budhgaon, Pune - 411 004

Chaitanya Electrocontrols

AJ27Ekdant Appartment, Behind Katraj Dairy, Katraj, Pune — 41 1 046

GST No. 27 ABWPG0598CIZE Mob. No. , 9730601814

CERTIFICATE FOR TRAINING.

(To whom so ever it may concern)

This is certify that Miss. Sakshi Nemgonda Patil student of Padmabhooshan Vasentraodada Patil Institute of Technology, Budhgaon has satisfactorily completed his training in our organization Chaitanya Electrocontrols, Pune for a period of 30 Days from 01/06/2023 to 01/07/2023.

During this period he got hands on site experience for Testing, servicing & Maintenance of lead acid stationary battery at EHV S/s. We wish him a good carrier ahead.

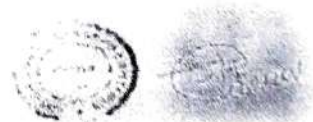

Authorized Signature

- MFRS OF POWER & DISTRIBUTION TRANSFORMERS
- MOBILE ULTRA HI-VACUUM FILTRATION PLANT



Date: 25.09.2022

TO WHOM SO EVER IT MAY CONCERN

Ref No: RIT/Elect/1860/2022

Date: 01.07.2023

This is to certify that, **Shivtej Rajendra Magdum** student of Class (**TY**)
 B Tech in Electrical Engg. **P.V.P Institute of technology budhgaon** has
 undergone Industrial training program as a part of syllabus from **01.06.2023** to **01.07.2023**

In this program he studied following basics of Transformer Manufacturing Industry:-

- 1 Introduction to raw material
- 2 Manufacturing process
- 3 Routine Testing of 3-Phase Distribution Transformer

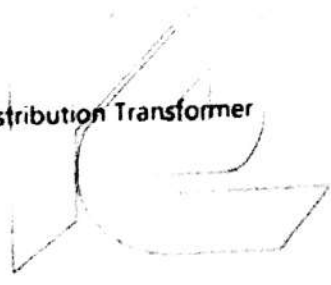

FOR POWER ENGINEERS

AUTHORISED SIGNATORY

P.V.P
 Padmabhooshan Vasantraodade Patil
 Institute of Technology
 BUDHGAON - 416 304



CERTIFICATE OF APPRECIATION

SGP Instruments

This is to certify that mr. AJINKYA B. SANKPAL
has completed the preserved course of basic
internship in our company during period from
10/10/2022 To 10/01/2023 in the designed
trade of Electrical Equipments & testing.

We wish her/his success in all her/his future carrier.

Place : Sangli

hshphalle@gmail.com



Harshal Phalle
Mr. Harshal Phalle
Sangli

Chaitanya Electrocontrols

A]27Ekdant Appartment, Behind Katraj Dairy, Katraj, Pune — 41 1 046

GST No. 27 ABWPG0598CIZE Mob. No. , 9730601814

CERTIFICATE FOR TRAINING.

(To whom so ever it may concern)

This is certify that Miss. Benjir Moula Mujawar student of Padmabhooshan Vasatraodada Patil Institute of Technology, Budhgaon has satisfactorily completed his training in our organization Chaitanya Electrocontrols, Pune for a period of 30 Days from 01/06/2023 to 01/07/2023.

During this period he got hands on site experience for Testing, servicing & Maintenance of lead acid stationary battery at EHV S/s. We wish him a good carrier ahead.

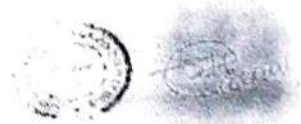

Authorized Signature

Chaitanya Electrocontrols

A]27Ekdant Appartment, Behind Katraj Dairy, Katraj, Pune — 41 1 046

GST No. 27 ABWPG0598CIZE Mob. No. , 9730601814

CERTIFICATE FOR TRAINING

(To whom so ever it may concern)

This is certify that Mr. Amey Vidyadhar Ingale student of Padmabhooshan Vasantryadada Patil Institute of Technology, Budhgaon has satisfactorily completed his training in our organization Chaitanya Electrocontrols, Pune for a period of 30 Days from 01/06/2023 to 01/07/2023.

During this period he got hands on site experience for Testing, servicing & Maintenance of lead acid stationary battery at EHV S/s.
We wish him a good carrier ahead.



Authorized Signature

Principal
Padmabhooshan Vasantryadada Patil
Institute of Technology
BUDHGAON - 416 304



TO WHOM SO EVER IT MAY CONCERN

Ref No: RIT/Elect/1860/2022

Date: 01.07.2023

This is to certify that, **Priya Uday Mule** student of Class (TY)
 B. Tech in Electrical Engg. **P.V.P Institute of technology budhgaon** has
 undergone Industrial training program as a part of syllabus from **01.06.2023** to **01.07.2023**

In this program he studied following basics of Transformer Manufacturing Industry:-

1. Introduction to raw material
2. Manufacturing process
3. Routine Testing of 3-Phase Distribution Transformer

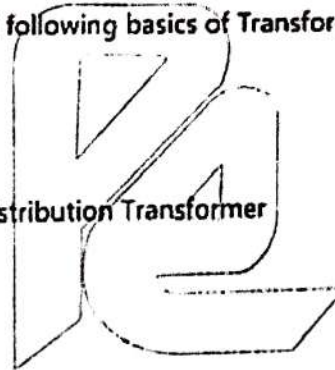

FOR POWER ENGINEERS

AUTHORISED SIGNATORY

Chaitanya Electrocontrols

A]27Ekdant Appartment, Behind Katraj Dairy, Katraj, Pune — 41 1 046

GST No. 27 ABWPG0598CIZE Mob. No. , 9730601814

CERTIFICATE FOR TRAINING

(To whom so ever it may concern)

This is certify that Mr. Omkar Hindurao Suryavanshi student of Padmabhooshan Vasandraodada Patil Institute of Technology, Budhgaon has satisfactorily completed his training in our organization Chaitanya Electrocontrols, Pune for a period of 30 Days from 01/06/2023 to 01/07/2023.

During this period he got hands on site experience for Testing, servicing & Maintenance of lead acid stationary battery at EHV S/s. We wish him a good carrier ahead.

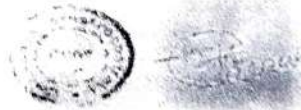

Authorized Signature

CERTIFICATE



Pantech e Learning
DIGITAL LEARNING SIMPLIFIED

CERTIFICATE NO

PEL_EVMC_PART_382

PANTECH SOLUTIONS
Technology Beyond The Dreams

**CERTIFICATE
OF PARTICIPATION**

NAME RUTUJA MANOHAR PATIL
COLLEGE P.V.P.I.T. BUDHGAON, SANGLI

has Successfully Completed
30 Days Masterclass on Electric Vehicle Design

at Pantech e Learning Pvt Ltd, Chennai

From 28.06.2023 to 28.07.2023

Sh. K. K. Thakur
CHAIRMAN
IETE, Ranchi

M. Malaiyappan
Director
Pantech e learning

Principal
Padmabhooshan Vasantraodada Patil
Institute of Technology
BUDHGAON - 416 304



Authorised Dealers Of Okinawa E Scooters
CHETANA AUTOMOBILES



32798 7L, Opposite to DMA Hall, Madhavnagar Road,
Sangli, Maharashtra 416416
☎ 7278417878 9423872100 | chetanaautomobiles22@gmail.com

Date - 20/12/2023



Certificate of Internship

This is to certify that Ms. Sujata Ramesh Jadhav has
successfully completed internship program of Electric Vehicle from
02 May 2023 to 01 June 2023. During the internship period the
student was found to be dedicated, hardworking & diligent.

For CHETANA AUTOMOBILES
Chetana Automobiles, Sangli
Proprietor

Principal
Padmahooshali Vasantraodada Patil
Institute of Technology
BUDHGAON - 415 304

Er.Akshay Dilip koli
Mob: 9637603838
8275611300

M C NO.2163100012 28112019

M/S. A. K. POWER LINES
GOVT. LICENSED ELECTRICAL CONTRACTOR

A/P : Uchagaon Tal: Karveer, Dist :Kolhapur. Email : akpowerlines@gmail.com

Date:- 02Jan2023

INTERNSHIP CERTIFICATE

The H.O.D – Electrical Department
P.V.P. Institute of technology
Budhgoan.

This is to certify that. **Mr. Ajit Mohan Jadhav** Of **B. Tech. Final year in Electrical Engineering** from the **College Padmabhushan Vasantro Dada Patil Institute of Technology, Budhgaon** has completed Internship in **A. K. Power Lines, Kolhapur** in the Period of **2 January 2023 to 2 February 2023**. According to this he completed **5 Weeks** Internship.

In the Internship period we found him a sincere, honest, *hardworking*, dedicated trainee with a professional attitude and very *good job knowledge*. In this duration we gave him training of all types of *Installation of Transformers & Transmission of LT Line*. We found him *work satisfactory* because of his sincerity, dedication and hard work.

We have found him to be a self-starter who is new invention view.
We wish him all the best and success in future career.

Yours Faithful

A.K. Power Lines



Padmabhushan Vasantro Dada Patil
Institute of Technology
Budhgaon - 416 304

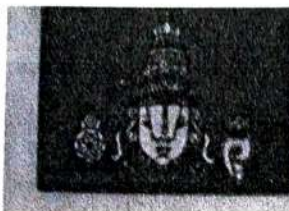

VENKATESHWARA ENTERPRISES

All Types of Submersible Pump, Supreme & HDPE Pipe, Starter Panel.
Office : Shivaji Chowk, Mangalwar Peth, Miraj, Dist. Sangli. 416 410 (M.S.)
Cell : +91 9226797744, 8830778020 Email : vyankateshwara.en@gmail.com

This is to certify that Ms. Tejashri Rajendra Mali. Student Of Padmabhooshan

Vasantrodada Patil Institute of Technology College in Budhgaon, Sangli. Has

Successfully Completed Industrial Training At our works, during period 01/04/23 to

20/05/23.

During period of training we found her sincere, honest and dedicated to learn.



Principal
Padmabhooshan Vasantrodada Patil
Institute of Technology
BUDHGAON - 416 304

Er.Akshay Dilip koli
Mob: 9637603838
8275611300

MC NO.2163100012 28112019

M/S. A. K. POWER LINES
GOVT. LICENSED ELECTRICAL CONTRACTOR

A/P : Uchgaon Tal: Karveer, Dist :Kolhapur. Email : akpowerlines@gmail.com

Date:- 02Jan2023

INTERNSHIP CERTIFICATE

The H.O.D – Electrical Department
P.V.P. Institute of technology
Budhgaon.

This is to certify that. **Mr. Pritam Rajesh Mirajkar Of B. Tech. Final year in Electrical Engineering** from the College **Padmabhushan Vasantro Dada Patil Institute of Technology, Budhgaon** has completed Internship in **A. K. Power Lines, Kolhapur** in the Period of **2 January 2023 to 2 February 2023**. According to this he completed **5 Weeks** Internship.

In the Internship period we found him a sincere, honest, *hardworking*, dedicated trainee with a professional attitude and very *good job knowledge*. In this duration we gave him training of all types of *Installation of Transformers & Transmission of LT Line*. We found him *work satisfactory* because of his sincerity, dedication and hard work.

We have found him to be a self-starter who is new invention view.
We wish him all the best and success in future career.

Yours Faithful

A.K. Power Lines



Principal
Padmabhushan Vasantro Dada Patil
Institute of Technology
BUDHGAON - 416 304



Authorised Dealers Of Okinawa E Scooters

CHETANA AUTOMOBILES

32798 7L, Opposite to DMA Hall, Madhavnagar Road,
Sangli, Maharashtra 416416

C 7278417878 9423872100 : chetanaautomobiles22@gmail.com



Date - 20/12/2023



Certificate of Internship

This is to certify that Ms. Sujata Ramesh Jadhav has
successfully completed internship program of Electric Vehicle from
02 May 2023 to 01 June 2023. During the internship period the
student was found to be dedicated, hardworking & diligent.

FOR CHETANA AUTOMOBILES
Chetana Automobiles, Sangli
Proprietor

Padmashankar V. Santhoshkar Patil
Institute of Technology
BUDHGAON - 416 304

ASE**M/S. ANAND SAGAR ENGINEERS**

FCC, MCC, PLC, VFD BUSDUCTY etc. types of Electrical Panel's Manufacturer, Govt. Licence Electrical Contractor M.C.NO:23769 LT & HT Line Erection & Substation, All Industries Electrical Project Works.
 Plot No: P86, M.I.D.C., Kupwad, 415438 Dist. SANGLI (M.S). Mob No: 9028081112
 E-mail: anandsagarengg@gmail.com

Ref: ASE//2018-2020/01

Date: 20/06/2023

CIRITIFICATE

This is to certify that Ms.Suryawanshi Tejal Laxman B.Tech SE (Electrical Engineering) of PVPIT have completed/partially completed their Industrial Training undermentorship of my firm Anand Sagar Engineers dated from 15/05/2023 to 16/06/2023 during the academic year 2023-2024 as partial fulfillment of the B.Tech (Electrical Engineering)

Thanking you,
 Yours faithfully,

For M/s Anand Sagar Engineers
 (Mr. RUPESH .S. KARNALE)

ANAND SAGAR ENGINEERS

R.S.
PROPRIETOR

Certificate

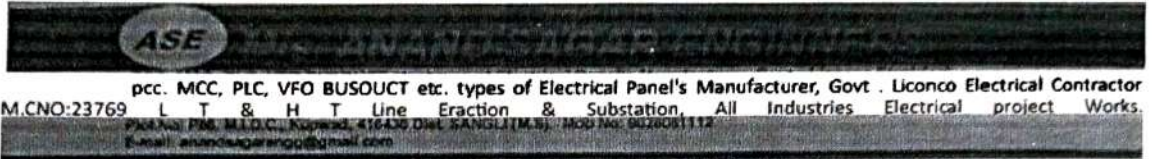

PM. M...D.C. Kupwxf. 416436

Re': ASEU2019-2020r01

Date: 10/04/2023

CERTIFICATE

This is to certify that Ms.Avantika Ranjeet Chavan B. Tech{Electrical Engineering} of PVPIT have completed / partially completed their Industrial Training undermentorship of my firm Anand Sagar Engineers dated from 25/03/2023to 06/04/2023 during the academic year 2023-2024as partial fulfillment of the B. Tech {Electrical Engineering}

[Signature]

For: M/S An.nd S.gar Engineer.

(Mr. RUPESH S. KARNALE)

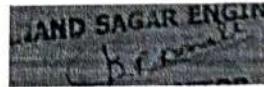

GINEERS

P OPRIETOP

Principal
 Padmabhooshan Vasantraodada Patil
 Institute of Technology
 BUDHGAON - 416 304



TO WHOM SO EVER IT MAY CONCERN

Ref No: RIT/Elect/1860/2022

Date: 01.07.2023

This is to certify that, *Sufiyan Gous Khatib* student of Class (TY) B. Tech in Electrical Engg. *P.V.P Institute of Technology budhgaon* has undergone Industrial training program as a part of syllabus from 01.06.2023 to 01.07.2023

In this program he studied following basics of Transformer Manufacturing Industry:-

- 1. Introduction to raw material
- 2. Manufacturing process
- 3. Routine Testing of 3-Phase Distribution Transformer

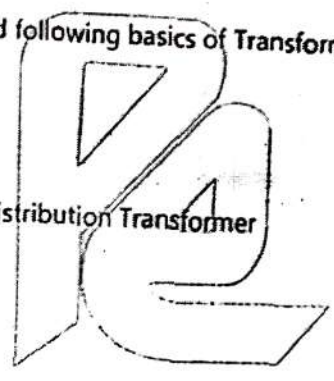

FOR POWER ENGINEERS

AUTORISED SIGNATORY

Pr. V. P.
Pr. V. P. Institute of Technology
BUDHGAON - 416 304

CERTIFICATE:

ASE **M/s. Anand Sagar Electrical's**
 PCC, MCC, PLC, VFD BUSDUCT etc. types of Electrical Panel's Manufacturer, Govt. Licence Electrical Contractor M.C.NO:23769 L T & H T Line Erection & Substation, All Industries Electrical Project Works. Plot No: P86, M.I.D.C., Kupwad, 416438 Dist. Sangli (M.S) Fax: 0233/2646828., 0233/3200184, Mob No: 09423872557, 09422042030, 9767582200 E-mail: anandsagarele@gmail.com, anandsagarele@rediffmail.com

DATE-03/09/2022

INTERNSHIP CERTIFICATE

This is to certify that MS. Chinmaya Bhagvan Sawant has successfully completed 1 MONTH (01/08/2022 To 01/09/2022) Internship program at "Anand Sagar Electricals, Kupwad".

During his stay we observe she obedient, honest, hardworking and dedicated employee with professional attitude and very good job knowledge. We have no objection to allow she in any better position and have no liabilities in our company.

Sincerely,
For Anand Sagar Electricals,
Kupwad.



[Signature]
Authorized signatory.

[Signature]
Principal
Padmanabhooshan Vasantraodade Patil
Institute of Technology
BUDHGAON - 416 304

CERTIFICATE

ASE

M/s. Anand Sagar Electrical's

PCC, MCC, PLC, VFD BUSDUCT etc. types of Electrical Panel's Manufacturer, Govt. Licence Electrical Contractor M.C.NO:23789 L T & H T Line Erection & Substation. All Industries Electrical Project Works. Plot No: P86, M.I.D.C., Kupwad, 416436 Dist. Sangli (M.S) Fax: 0233/2648828., 023313200184, Mob No: 09423872557.09422042030,9787582200E-mail: anandsagarele@gmail.com,anandsagarele@rediffmail.com

DATE-10/04/2023

INTERNSHIP CERTIFICATE

This is to certify that MS. Pratiksha Ramu Mangave has successfully completed 1 MONTH (08/03/2023 To 06/04/2023) Internship program at "Anand Sagar Electricals, Kupwad".

During his stay we observe she obedient, honest, hardworking and dedicated employee with professional attitude and very good job knowledge. We have no objection to allow she in any better position and have no liabilities in our company.

Sincerely,
For Anand Sagar Electricals,
Kupwad.



Authorized signatory.

Principal
Padmashooshan Vasantaoada Patil
Institute of Technology
BUDHGAON - 416 304

CERTIFICATE

ASE *M/s. Anand Sagar Electricals*

PCC, MCC, PLC,VFD BUSDUCT etc. types of Electrical Panel's Manufacturer, Govt . Licence Electrical Contractor M.C.NO:23769 L T & H T Line Erection & Substation, All Industries Electrical Project Works. Plot No: P88, M.I.D.C., Kupwad, 416436 Dist. Sangli (M.S) Fax: 0233/2646828.,0233/3200184, Mob No: 09423872557,09422042030,9767582200E-mail: anandsagarele@gmail.com,anandsagarele@rediffmail.com

DATE-03/09/2022

INTERNSHIP CERTIFICATE

This is to certify that **MS. Shweta Ramesh Satpute** has successfully completed 1 MONTH (01/08/2022 To 01/09/2022) Internship program at "Anand Sagar Electricals,Kupwad" .

During his stay we observe she obedient, honest, hardworking and dedicated employee with professional attitude and very good job knowledge.We have no objection to allow she in any better position and have no liabilities in our company.



Sincerely,
For Anand Sagar Electricals,
Kupwad.

[Signature]
Authorized signatory.

[Signature]
Principal
Padmabhooshan Vasantkrushna P.
Institute of Technology
BUDHGAON - 416 304

ASE

PCC, MCC, PLC, VFD BUSDUCT etc. types of Electrical Panel's Manufacturer, Govt .Licence Electrical Contractor M.C.NO:23769 L T & H T Line Erection & Substation, All Industries Electrical Project Works. Plot No: P88, M.I.D.C., Kupwad, 416436 Dist. SANGLI (M.S). Mob No: 9028081112 E-mail: anandsagarengg@gmail.com

Ref: ASE//2019-2020/01

Date: 10/04/2022

This is to certify that Ms. Akanksha Pramod Pawar Student Of Padmabhooshan Vasantraodada Patil Institute of Technology College in Budhgaon, Sangli. Has Successfully Completed Industrial Training At our works, during period 25/05/23 to 06/06/23. During period of training we found her sincere, honest and dedicated to learn.

for: M/s Anand Sagar Engineers
(Mr. RUPESH .S. KARNALE)

ANAND SAGAR ENGINEERS

R. Karnale
PROPRIETOR

AK
Principal
Padmabhooshan Vasantraodada Patil
Institute of Technology
BUDHGAON - 416 304

ASE

M/s. Anand Sagar Electrical's

PCC, MCC, PLC, VFD BUSDUCT etc. types of Electrical Panel's Manufacturer, Govt. Licence Electrical Contractor M.C.NO:23769 L T & H T Line Erection & Substation, All Industries Electrical Project Works. Plot No: P86, M.I.D.C., Kupwad, 410430 Dist. Sangli (M.S) Fax: 0233/2646828, 0233/3200184, Mob No: 09423872557, 09422042030, 9767562200E-mail: anandsagarele@gmail.com, anandsagarele@rediffmail.com

DATE-03/09/2022

INTERNSHIP CERTIFICATE

This is to certify that **MS. Namira Rashid Kazi** has successfully completed 1 MONTH (01/08/2022 To 01/09/2022) Internship program at "Anand Sagar Electricals, Kupwad" .

During his stay we observe she obedient, honest, hardworking and dedicated employee with professional attitude and very good job knowledge. We have no objection to allow she in any better position and have no liabilities in our company.

Sincerely,
For Anand Sagar Electricals,
Kupwad.



Authorized signatory.

Principal
Institute of Technology
BUDHGAON - 416 304

ASE

PCC, MCC, PLC, VFD BUSDUCT etc. types of Electrical Panel's Manufacturer, Govt. Licence Electrical Contractor M.C.NO:23769 L T & H T Line Erection & Substation, All Industries Electrical Project Works.
Plot No. P86, M.I.D.C., Kupwad, 416436 Dist. SANGLI (M.S). Mob No: 9028081112
E-mail: anandsagareng@gmail.com

Ref: ASE//2019-2020/01

Date: 10/04/2022

This is to certify that Ms. Vaishnavi Vitthal Chougule Student Of Padmabhooshan
Vasatraodada Patil Institute of Technology College in Budhgaon, Sangli. Has
Successfully Completed Industrial Training At our works, during period 25/05/23 to
06/06/23.
During period of training we found her sincere, honest and dedicated to learn.

or: M/s Anand Sagar Engineers
(Mr. RUPESH .S. KARNALE)

ANAND SAGAR ENGINEERS

PROPRIETOR

 Padmabhooshan Vasatraodada Patil
 Institute of Technology
 BUDHGAON - 416 304



TO WHOM SO EVER IT MAY CONCERN

Ref No: RIT/Elect/1860/2022

Date: 01.07.2023

This is to certify that, **Vinay Sunil javir** student of Class (**TY**)
B. Tech in Electrical Engg. P.V.P institute of technology budhgaon has
 undergone Industrial training program as a part of syllabus from **01.06.2023** to **01.07.2023**

In this program he studied following basics of Transformer Manufacturing Industry:-

1. Introduction to raw material
2. Manufacturing process
3. Routine Testing of 3-Phase Distribution Transformer

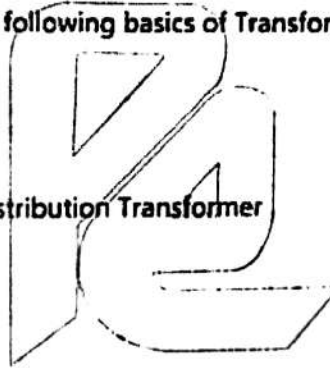

FOR POWER ENGINEERS

AUTHORISED SIGNATORY

Institute of Technology
 BUDHGAON - 416 304

- MFRS. OF POWER & DISTRIBUTION TRANSFORMERS.
- MOBILE ULTRA HI-VACUUM FILTRATION PLANT.



AN ISO : 9001-2008 COMPANY

POWER ENGINEERS

TO WHOM SO EVER IT MAY CONCERN

Ref No: RIT/Elect/1860/2022

Date: 01.07.2023

This is to certify that, **Prerana Mohan Kanse** student of Class (**TY**)
 B. Tech in Electrical Engg. **P.V.P institute of technology budhgaon** has
 undergone Industrial training program as a part of syllabus from **01.06.2023** to **01.07.2023**

In this program he studied following basics of Transformer Manufacturing Industry:-

1. Introduction to raw material
2. Manufacturing process
3. Routine Testing of 3-Phase Distribution Transformer

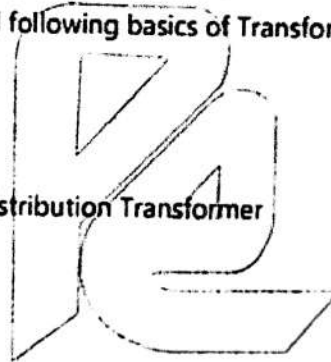

FOR POWER ENGINEERS

AUTHORISED SIGNATORY

Principal
 Dagmabhooshan Vasantraodade Paw
 Institute of Technology
 BUDHGAON - 416 304



MAHARASHTRA STATE ELECTRICITY TRANSMISSION COMPANY LIMITED
(CIN NO-U40109MH2005SGC153646)

From: Additional Executive Engineer 220 kV Sahara Sub-Station, A/p- Kumbheri, Tal-Mulshi, Dist-Pune-412108 Cell No-9860555500/7447440305. E-Mail Id: adeeh470@mahatransco.in	To: Mr. Shikalgar Mahamed Salauddin Niyaj Ali Miraj Dist-Sangli.
Ref.No: ADEE/220kV Sahara/325 Date: 16-06-2023	

TO WHOM SO EVER IT MAY CONCERN

This is certify that Mr.Shikalgar Mahamed Salauddin Niyaj Ali has successfully completed the internship program at 220 kV Sahara Sub-station MSETCL for the duration from 01.06.2023 to 15.06.2023.

In recognition of their dedication, commitment and valuable contributions in the field of Operation & Maintenance department of 220kV Sahara Sub-station MSETCL.

During this tenure we found him hard working & Sincere.

We Wish him all success in his future ventures.

[Handwritten Signature]
 16.06.23

- MFRS. OF POWER & DISTRIBUTION TRANSFORMERS.
- ▼ MOBILE ULTRA HI-VACUUM FILTRATION PLANT.



AN ISO : 9001-2008 COMPANY

POWER ENGINEERS

TO WHOM SO EVER IT MAY CONCERN

Ref No: RIT/Elect/1860/2022

Date: 01.07.2023

This is to certify that, **Suyash Bajirao Patil** student of Class (**TY**)
 B. Tech in Electrical Engg. **P.V.P institute of technology budhgaon** has
 undergone Industrial training program as a part of syllabus from **01.06.2023** to **01.07.2023**

In this program he studied following basics of Transformer Manufacturing Industry:-

1. Introduction to raw material
2. Manufacturing process
3. Routine Testing of 3-Phase Distribution Transformer

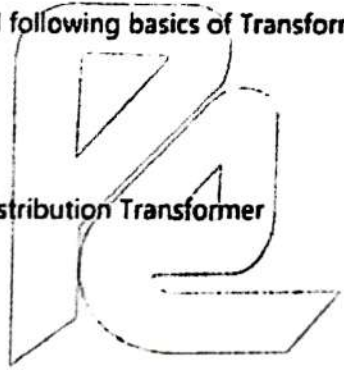

FOR POWER ENGINEERS

AUTHORISED SIGNATORY

Principal
 Padmabhooshan Vasantraodade Paa
 Institute of Technology
 BUDHGAON - 416 304



TO WHOM SO EVER IT MAY CONCERN

Ref No: RIT/Elect/1860/2022

Date: 01.07.2023

This is to certify that, *Ravindra Raju Arjun* student of Class (TY)
 B. Tech in Electrical Engg. *P.V.P institute of technology budhgaon* has
 undergone Industrial training program as a part of syllabus from 01.06.2023 to 01.07.2023

In this program he studied following basics of Transformer Manufacturing Industry:-

1. Introduction to raw material
2. Manufacturing process
3. Routine Testing of 3-Phase Distribution Transformer

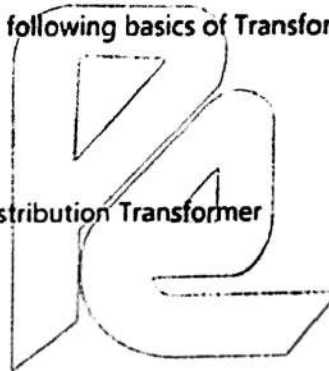

FOR POWER ENGINEERS

AUTHORISED SIGNATORY

Principal
 Padmabhooshan Vasantraodade P.V.P.
 Institute of Technology
 BUDHGAON - 416 304

Chaitanya Electrocontrols

A]27Ekdant Appartment, Behind Katraj Dairy, Katraj, Pune — 41 1 046

GST No. 27 ABWPG0598CIZE Mob. No. , 9730601814

CERTIFICATE FOR TRAINING

(To whom so ever it may concern)

This is certify that Miss. Sakshi Balu Jambhale student of Padmabhooshan Vasatraodada Patil Institute of Technology, Budhgaon has satisfactorily completed his training in our organization Chaitanya Electrocontrols, Pune for a period of 30 Days from 01/06/2023 to 01/07/2023.

During this period he got hands on site experience for Testing, servicing & Maintenance of lead acid stationary battery at EHV S/s. We wish him a good carrier ahead.



Authorized Signature

Principal
Padmabhooshan Vasatraodada Patil
Institute of Technology
BUDHGAON - 416 300

- MFRS. OF POWER & DISTRIBUTION TRANSFORMERS.
- MOBILE ULTRA HI-VACUUM FILTRATION PLANT.



AN ISO : 9001-2008 COMPANY

**POWER
ENGINEERS**

TO WHOM SO EVER IT MAY CONCERN

Ref No: RIT/Elect/1860/2022

Date: 01.07.2023

This is to certify that, *Pratik Parshuram Suryavanshi* student of Class (TY)
B. Tech in Electrical Engg. *P.V.P institute of technology budhgaon* has
undergone Industrial training program as a part of syllabus from 01.06.2023 to 01.07.2023

In this program he studied following basics of Transformer Manufacturing Industry:-

1. Introduction to raw material
2. Manufacturing process
3. Routine Testing of 3-Phase Distribution Transformer

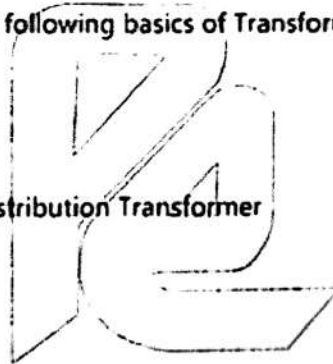

FOR POWER ENGINEERS

AUTHORISED SIGNATORY

Principal
Pradiphooshan Yasantraodade Patil
Institute of Technology
BUDHGAON - 416 304

CERTIFICATE

**MAHABAL METAL
PVT. LTD**

Date: 18 Jun, 2023.

**TO WHOMSOEVER IT MAY CONCERN
INTERNSHIP CERTIFICATE**

This is to certify that Miss. Sandhya Shailendra Sawant. student of PVPIT Budhagaon, final Year "Electrical Engineering" has successfully completed her internship in "Electrical Departement" at Mahabal Metal pvt.ltd Sangli,Kupwad from 5 May 2023 to 15 Jun 2023. She has worked on a project titled 'Machine Installation'.

During the internship she demonstrated good skills with a self-motivated attitude to learn new things. She'sperformance exceeded expectations and was able to complete the project successfully on time.

We wish him all the best for her future endeavors..

MAHABAL METAL PVT.LTD

Signature

MAHABAL METAL PVT.LTD
Plot, No.06 Gat no.34 SANGLI,KUPWAD.



Principal
Padmashreshan Kusurkudade Patil
Institute of Technology
BUDHGAON - 416 304

DEPARTMENT OF MECHANICAL ENGINEERING
List of Sponsored Project Academic Year 2022-23

Sr. No.	Project Batch.	Name of Guide/s	Names of students		Title of Project	Sponsored company	Email / Contact No.	Cost In Rs.
			Roll No					
1	P1A	/Mrs. S. P. Mane	4108	Prahlammesh Pradeep Kamble	Design & Development of floating fish feeding extruder	M/S GIRIJA INDUSTRIES, GAT NO 2001-2002, DATTANAGAR, PALUS	girijaindustries@yahoo.com 8975757499	
			4167	Paras P. Sargur				
			4119	Prahlammesh Shivaji Jadhav				
2	P3A	Mr. N. D. Patil	4127	Shreyansmath Mahesh Herwade	Design & CFD Analysis of Sump Flows in Pumping Stations	HYDROMODELLING AND SOLUTIONS, GAT NO-1005, NANDRE, DIST-SANGLI	info@hydromodel.org, hydrosolution.sangli@gmail.com	
			4131	Rantik Madhukar Chavhan				
			4135	Ketan Deepak Tiwade				
			4120	Ahmar Sadik Kokane				
3	P4A	Mr. A. S. Patil	4121	Omkar Jitendra Kulkarni	A METHODOICAL PERSPECTIVE FOR PLOTTING, SCRYTINIZING & CONSTRUCTING A MODEL FIXED wing RC PLANE	SAMMIDVAY P102 MIRAJ MIDC SANGLI		36800/-
			4122	Lihaj Abdulatif Tamboli				
			4124	Rushikesh Vishwanath Chavhan				
			4110	Sagar Namdev Lohar				
4	P5A	Mr. P. P. Awate	4112	Rohan Rakhmaji Mode	Fabrication of cattle feed making machine	ABHISHEK ENTERPRISES VASNTDADA INDUSTRIAL ESTATE SANGLI	9049742473	34789/-
			4114	Parth Shirikant Patil				
			4117	Abhishek Shashikant Howale				
			4137	Ganesh Hanmant Yadav				
5	P9A	Mr. P. P. Shinde	4138	Raturaj Dattatray Salunkhe	Design & Development of Cattle Feed making machine	JYOTIRLING DUDH SANKALAN KENDRA, KAMALAPUR,		15000/-
			4139	Yogesh Yuvraj Patil				
			4158	Aniket Vijay Jadhav				
			4129	Kunal Dilip Parve				
6	P10A	Mr. S.S. Gunjate	4132	Shreyas Vilas Mane	Design & Development of Hydraulic Valve Test Rig	SWARNIL INDUSTRIES, PLOT NO 168/3/6, OLD BUDHGAON ROAD LAXMI NAGAR- SANGLI	9423868777, 8605868777	24231/-
			4136	Vinud Madhukar Pise				
			4166	Sachin Shiridhar Mane				
			4106	Avishkar Tanaji Patil				
7	P12A	Mr. K. D. Ghatage	4123	Yash Raju Nirmale	Design & Development of Hydro Dynamic Journal Bearing Pressure Distribution Test Rig	SUPERSONIC ELECTRONICS, C-13, M.I.D.C, MIRAJ, DIST-SANGLI	072276026913, 9860578762	64000/-
			4128	Koustubh Arun Deshingre				
			4161	Mahesh Sanjay Patil				

DEPARTMENT OF MECHANICAL ENGINEERING
List of Sponsored Project Academic Year 2022-23

Sr. No.	Project Batch.	Name of Guide/s	Roll No	Names of students	Title of Project	Sponsored company	Email / Contact No.	Cost in Rs.
8	P13A	Mr. K. D. Ghatage	4107	Piyush Kailash Shintre	Design & Development of Hydro Dynamic Journal Bearing, Pressure Distribution Test Rig	SUPERSONIC ELECTRONICS, C-13, M.I.D.C, MIRAJ, DIST-SANGLI	07276026913, 9860578762	64000/-
			4142	Ashish Ramesh Kumbhar				
			4143	Rajwardhan Rajesh Deshpande				
			4146	Santosh Suresh Mane				
			4213	Vinaj Arun Pawar				
9	P1B	Mr. A S Patil	4225	Sanket Manik Pawar	Design & Development of Portable Electric Power tiller Machine	VALTECH BUILDING SOLUTION PVT. LTD PLOT NO D-84, 5 STAR M.I.D.C. KAGAL, KOLHAPUR	Valtech.pirajil@g mail.com 9552586354	16500/-
			4234	Nikhil Dilip Patil				
			4242	Rushikesh Chandrakant Patil				
			4206	Tejas Ajitkumar Khot				
			4208	Aniket Ambar Shinde				
10	P4B	Dr.S J Adsul	4209	Valbhav Popat More	Design & Development of Solar Operated Sunflower Seed Separator	ABHISHEK ENTERPRISE PLO NO 136 INDUSTRIAL ESTATE, SANGLI	Abhishek.sutar004@gmail.com 9049742473	9775/-
			4219	Pranav Ananda Kamble				
			4233	Sanket Raosaheb Upadhye				
			4235	Rohit Ravindra Jadhav				
11	P7B	Mr. C D Patil	4238	Vishal Sanjay Bansode	Effect of Pre-Treatment on Oil kitchen work and Biogas purification	SANGEETA INDUSTRIES 575/10, BEHIND WIN WIN INDUSTRIES, SHIROLI M.I.D.C. KOLHAPUR	sangeetaindul@gmail.com 9970575350	16750/-
			4240	Shantanu Sanjay Patil				
			4321	Shubham Tanaji Pawar				
			4326	Pramod Vasant Kamble				
			4327	Sahil Anil Patil				
12	P5C	N D Patil	4308	Rukaiyya Shakil Pathan	Optimization of Wire Electrical Discharge Machining (WEDM) Parameters for Surface finish and Material removal Rate	V.M. INDUSTRIES H3 NEAR PATEL PETROL PUMP,M.I.D.C. GOKUL SHIRGAON KOLHAPUR	Vm.industriesko p@gmail.com 7387808018	
			4309	Amit Vishwanath Tapase				
			4310	Nishant Umesh Bhurke				
			4324	Kartik G.Deshpande				
			4311	Sushant Mahadev Awati				
13	P7C	P P Shinde	4324	Kartik G.Deshpande	Design & Development of semi-automatic jig & Fixture	NEW SAI FIBERS BEHIND HINDU DHARM SHALA, OPP DR. KRISHINKANT HOS MIRAJ	newsaifiber@rediffmail.com 9822195015	20900/-
			4311	Sushant Mahadev Awati				

A Project report submitted in partial fulfillment of requirements for the award
of

BACHELORS DEGREE IN MECHANICAL ENGINEERING

Project on

"Design and Development of fish feed extruder"

Sr NO	NAME OF STUDENT	PRN NO
1	PRATHAMESH PRADEEP KAMBLE	1962691612156
2	OMKARSANJAY YESUGADE	1962691612025
3	Mr. PARAS POPAT SARGAR	1962691612152

Under the guidance of

Prof. S. P. Mane



DEPARTMENT OF MECHANICAL ENGINEERING 2022-2023
PADMA BHOSHAN VASANTRAO DADA PATIL INSTITUTE

OF TECHNOLOGY, BUDHGAON
DEPARTMENT OF MECHANICAL ENGINEERING

CERTIFICATE



This is Certify That Project Report Of
Design and development of fish feed extruder
Submitted By,

Sr NO	NAME OF STUDENT
1	PRATHAMESH PRADEEP KAMBLE
2	OMKARSANJAY YESUGADE
3	Mr. PARAS POPAT SARGAR

Is in partial fulfillment of the requirement for award of Bachelor's degree in
Mechanical Engineering by Dr. Babasaheb Ambedkar Technological University,
Lonere

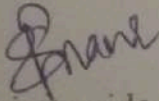
Project guide
Prof. S.P. Mane

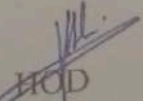
HOD
Prof. A.P. Shrotri

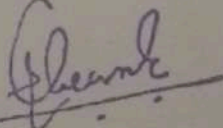
Principle
Dr. D.V. Ghewade



M/s. Girija Industries



Mfg. All Types of Heavy Fabrication & Precision Machining Works

Gat No. 2001- 2002, Dattanagar, Palus - 416 310, Tal. Palus Dist. Sangli

Mob. : 8975757499 Email: girjaindustries@yahoo.com

Date: 07 Sep 2022

Ref. No. :

Date :

The Principal,

P.V.P.L.T. Budhgaon,

Reference: Request letter of Final Year B. Tech (Mechanical Engg.) Mech. students

Subject: Sponsorship for Final Year B. Tech (Mechanical Engg.) Project

Dear Sir,

With reference to the application letter mentioned above for the sponsorship of industrial project,

We are very glad to inform you that the work titled as " Fabrication of Fish Feed Extruder " is allotted to Batch-PIA as sponsored project, on following term and conditions.

Term and conditions

1. The project work will be the sole property of the company and retained by us.
2. The required materials, fabrication, design and testing facility etc. will be made available as far as possible
3. The necessary data and record supplied as well as the project related result are the sole property of the company and strictly to be used for academic purpose, however the publication of work as a research is permitted.
4. Period of project completion will be 3 months.

Please forward your acceptance in this regards.

Thanking you,

With best Regards



Signature of head of company with seal:

Chapter	Title	Page no
1	Introduction	10
	1.1 Introduction	11
	1.2 Problem Definition	12
	1.3 Objective	12
	1.4 Scope of the Project	12
2	Literature Review	15
	Working principle of extruder	18
3	Design Calculation	21
	3.1 Hopper Design	22
	3.2 Determination of screw conveyer diameter and power to drive conveyer	23
	3.3 Length of Screw	24
	3.4 Determination of Pulley Diameter	25
	3.5 Design of Barrel	25
	3.6 Design of Frame	25
4	Design and Fabrication of Components	26
	4.1 Design	27
	4.2.1 Die entry	28
	4.2.2 Die Plate	29
	4.2.3 Die Holder	30
	4.2.4 Pulley	31
	4.2.5 Feed Pipe	32

4.2.3 DIE HOLDER

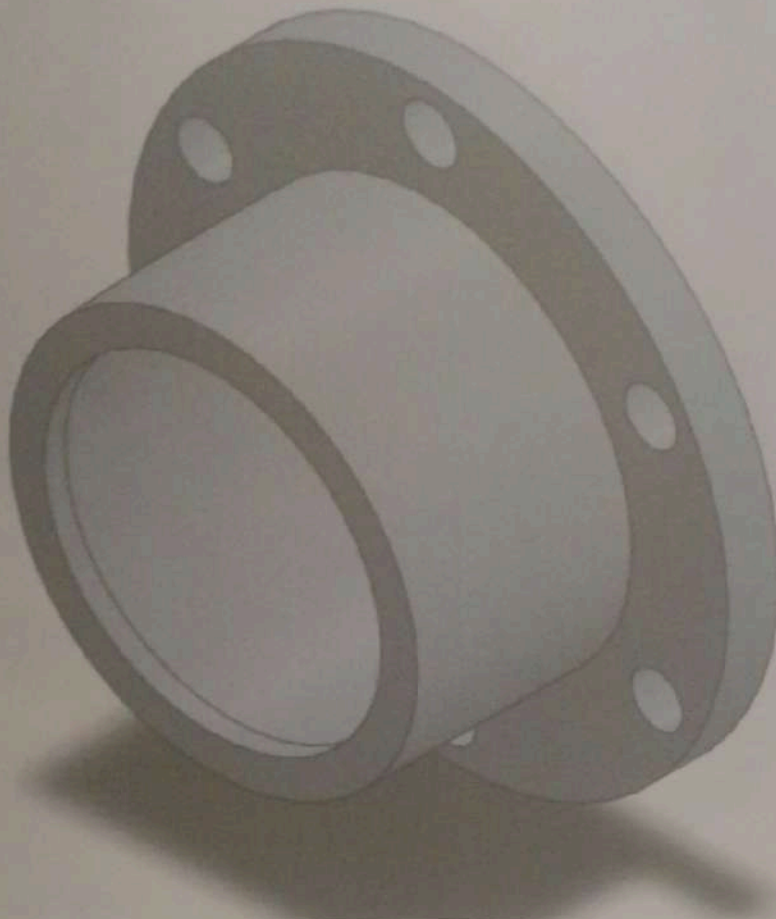

Fig No.6

Die holder, Material used to make die holder is mild steel by using round block with size $\text{Ø}110\text{mm} \times 52\text{mm}$ after machining on lathe machine following parameters are arrived

1. Diameter 1 = $\text{Ø}110\text{mm}$
2. Diameter 2 = $\text{Ø}73\text{mm}$
3. Bore Diameter = $\text{Ø}66.30\text{mm}$
4. Drilling Details = 06 Hole $\text{Ø}10\text{mm}$ position off center through.
5. Width = 52m

3.1 HOPPER DESIGN

The shape of the hopper is in the form of a truncated pyramid with an inclination angle of 45° to enable conveying and storage of raw materials.

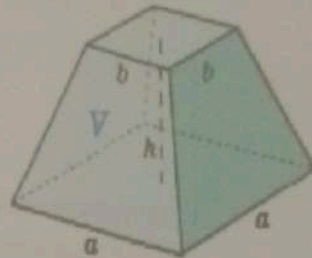

Fig No. 2

$$\text{VOLUME OF HOPPER} = (a^2 + b^2 + ab) h / 3$$

Where $b=50\text{mm}$, $a=70\text{mm}$, $h=100\text{mm}$

therefore,

$$V = [4900 + 2500 + (50 \times 70)] 100 / 3 = 363333 \text{mm}^3$$

$$V = 0.0003633 \text{m}^3$$

The mass flow through the hopper using Johanson equation is calculated thus

$$\text{Mass flow} = \rho^0 A \sqrt{\frac{B g}{2(1+m) \tan \phi}}$$

Where:

ρ^0 = bulk density of the material (785 kg/m³ assumed)

A = surface area of hopper ($W \times L = 0.070 \times 0.070 = 0.0049 \text{m}^2$)

ϕ = hopper angles = 45 deg

g = acceleration due to gravity (9.807 m/s²)

$m = 0$ (symmetrical slot hopper)

$B = w = 0.070 \text{m}$

Therefore, mass flow through the hopper = $785 \times 0.0049 \sqrt{0.070 \times 9.807 / 2 \tan 45}$

$$= 8112.26029 \text{ kg/s}$$

A PROJECT REPORT ON
*"Design and CFD analysis of sump
flows in pumping stations."*

SUBMITTED TO

Dr. BABASAHEB AMBEDKAR TECHNOLOGICAL UNIVERSITY, LONERE

In Partial Fulfillment for the Degree of BACHELOR OF TECHNOLOGY

in

Mechanical engineering

SUBMITTED BY

Mr. Jadhav.S. Prathmesh	1962691612144
Mr. Herwade M Shreyansnath	1962691612072
Mr. Chavan M Rutik	1962691612083
Mr. Ketan D Tiwade	1962691612032

UNDER THE GUIDANCE OF

Prof. N.D.Patil

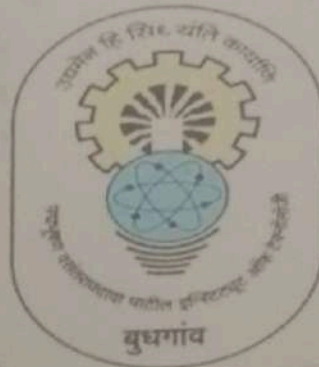

Certificate



“ Design and CFD analysis of sump flows in pumping stations.”

Submitted by

Name of Student	PRN NO
Mr. Jadhav .S. Prathmesh	1962691612144
Mr. Herwade M Shreyansnath	1962691612072
Mr. Chavan M Rutik	1962691612083
Mr. Ketan D Tiwade	1962691612032

to Dr. BABASAHEB AMBEDKAR TECHNOLOGICAL UNIVERSITY, LONERE, in partial fulfillment for the award of the degree of **B. Tech in Mechanical Engineering** is a *bonafide* record of project work carried out by him under my/our supervision. The contents of this report, in full or in parts, have not been submitted to any other Institution or University for the award of any degree.

Guide

Prof. N.D.Patil

HOD

Dr.A.P. Shroti

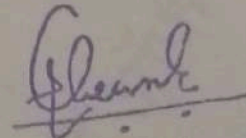
Principal

Prof.Dr. D. V. Ghewade

Date:-12/06/2023

To,

R.O.D.

Department of Mechanical Engineering,

P.V.P.I.T, Bodhgawa,

Sangli

Subject: Sponsorship for the Project work of Undergraduate students of P.V.P.I.T

Dear Sir,

As per our Memorandum of understanding we are ready to sponsor your following students for their project working B.tech. Mechanical Engineering year (2022-2023). We will provide all the data and other required assistance for the project work, however the final outcome of the project work shall be the property of our organization. It is mandatory for the students to complete task as per the commitment.

Name of the students

Sr.no.	Name of Students	Class	Roll no
1	Prathmesh S. Jadhav	Btech A	4119
2	Shrayannath M. Herwade	Btech A	4127
3	Rutik M. Chavan	Btech A	4131
4	Ketan D. Trwade	Btech A	4135

(Sign & Seal of Director)

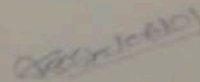

CONTENTS

Content	Page no.
Introduction:	9
• Computational Fluid Dynamics	11
• Problem Statement:	12
• Thesis Statement:	13
• Relevance of the Project:	14
• Application of CFD Analysis :	15
• importance of project area:	16
• Research Objectives	17
Literature Survey	12
Main Parts Of The Setup	14
Design Specifications for Sump System Optimization	17
Construction & Working	19
Testing & Results	22
Advantges & Conclusions	29
Future scope	30
Refrence	32



CHAPTER 6

TESTING AND RESULTS

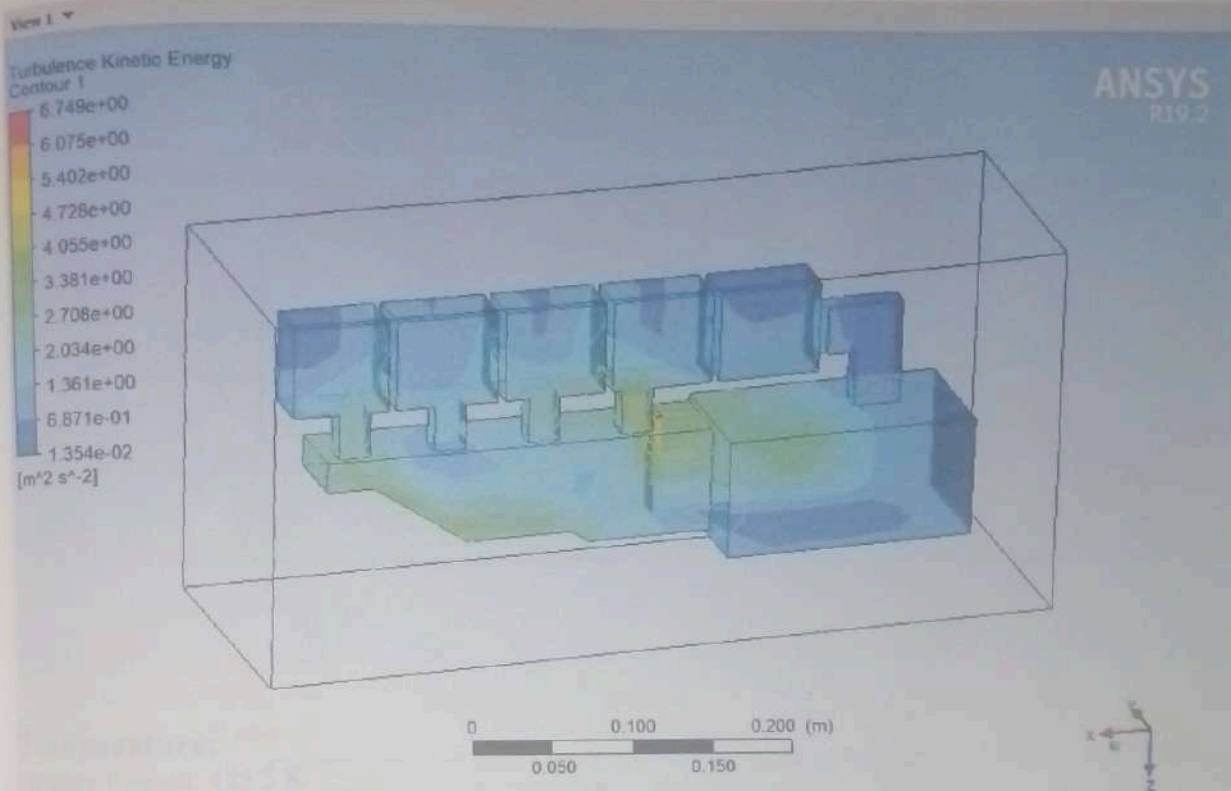

Turbulence Kinetic Energy:

Orange Region: 6.749

Blue Region: 0.01345

The turbulence kinetic energy values indicate the level of turbulence or mixing in different color-coded regions of the fluid flow. The orange region exhibits a turbulence kinetic energy of 6.749, suggesting high turbulence intensity and strong mixing. In contrast, the blue region shows a significantly lower turbulence kinetic energy value of 0.01345, indicating lower turbulence intensity and relatively smoother flow characteristics.

The observed deflection between the turbulence kinetic energy values highlights the variation in turbulence intensity between the orange and blue regions. Further analysis of the flow field, geometry, and boundary conditions will help to understand the underlying causes of this deflection and its implications for factors such as heat transfer, fluid flow behavior, and pressure distribution in the respective regions.



A

Report submitted to

**Dr. BABASAHEB AMBEDKAR TECHNOLOGICAL
UNIVERSITY, LONERE**

In partial fulfilment for the Degree of
BACHELOR OF TECHNOLOGY

In

ROLL NO.	NAME OF STUDENT	PRN NO.
4120	Abrar Sadik Kokane.	1962691612066
4121	Omkar Jitendra Kulkarni.	1962691612011
4122	Lihaj Abdullatif Tamboli.	1962691612013
4124	Rushikesh Vishwanath Chavan.	1962691612075

B-TECH

MECHANICAL ENGINEERING (A)



**Department Of Mechanical Engineering
PADMABHOOSHAN VASANTRAODADA PATIL
INSTITUTE OF TECHNOLOGY BUDHGAON**

Department of Mechanical Engineering



CERTIFICATE

ROLL NO.	NAME OF STUDENT	PRN NO.
4120	Abrar Sadik Kokane.	1962691612066
4121	Omkar Jitendra Kulkarni.	1962691612011
4122	Lihaj Abdullatif Tamboli.	1962691612013
4124	Rushikesh Vishwanath Chavan.	1962691612075

**"A METHODOICAL PERSPECTIVE FOR PLOTTING, SCRYTINIZING &
CONSTRUCTING A MODEL FIXED WING RC PLANE."**

Submitted to Dr. BABASAHEB AMBEDKAR TECHNOLOGICAL
UNIVERSITY, LONERE. In partial fulfilment for the award of the degree of

B. Tech in Mechanical Engineering is a *bona fide* record of project work
carried out by him/her under my/our supervision. The contents of this report, in
full or in parts, have not been submitted to any other Institution or University
for the award of any degree or diploma

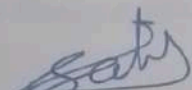
Mr. A.S. PATIL
Guide

Dr. A.P. SHROTRI
Head of Department

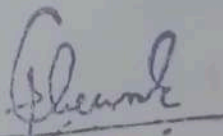
Dr. D.V. GHEWADE
Principal

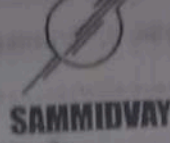

Udyam registration number: UDYAM-MH-29-0002645
Memorandum: MH29A0021138 | Type of enterprise: Micro Manufacturing

Date: 2/11/2022

To
Mr. Amod Shrotri
HOD. Mechanical dpt.
Padmabhooshan Vasantdada Patil Institute of Technology, Budhgav, Sangli, MH.

Official sponsorship letter for Academic Mega Project

Respected Sir

SAMMIDVAY, Sangli is UAV (unmanned Aerial Vehicle/Drone) design & manufacturing company, based in MIRAJ MIDC, sangli. Students approached for megaproject guidance. After detailed assessment of students (Name mentioned below), the SAMMIDVAY has decided to guide and provide project funding for "Multipurpose Fixed Wing RCplane" mega project. I write to confirm that the below mentioned students are in receipt of official technology sponsorship from us. The sponsorship covers electronic hardware & Project development material.

Should you require any further information please do not hesitate to contact us.

Note: Hardware provided for project is completely belongs to SAMMIDVAY, Firm will take back whole project hardware, once demonstration of project is over.

For SAMMIDVAY

Akshay
2-11-22
Proprietor

Akshay Chinchankar
SAMMIDVAY
Founder & Proprietor

-----For students acknowledgement (mandatory)-----

We will return whole provided parts back to SAMMIDVAY once demonstration is over. We will assure that all hardware part will remain safe during project development & demonstration. We the member of "Multipurpose Fixed Wing RCplane" project accepts all conditions applied from SAMMIDVAY.

Sr.no	Name	Roll no.	Dept.	Year	Sign
1	Abrar Sadik Kokane.	4120	Mech	4 th	<i>Abrar</i>
2	Omkar Jitendra Kulkarni	4121	Mech	4 th	<i>Omkar</i>
3	Lihaj Abdullah Tamboli	4122	Mech	4 th	<i>Lihaj</i>
4	Rushikesh Vishvanath Chavan	4124	Mech	4 th	<i>Rushikesh</i>

-----For Institute authorities acknowledgement (mandatory)-----

Please acknowledge this letter by signature of Official authority with institute stamp.

Amod
Mr. Amod Shrotri
Mechanical HOD

D. Ghewade
Mr. D. Ghewade
College Principal

Amarsingh
Mr. Amarsingh Patil
Mega Project guide

Our prototype-



9.3-Cost Estimation-

Sr. No.	Material Description	Qty. / Wt.	Amount (Rs)
1.	Remote	1	8000
2.	Battery	1	3000
3.	Motor	2	1200
4.	ESC	1	1100
5.	Charger	1	5000
6.	Propellers	4	1000
7.	Frame building material	4 ^{ft} *6 ^{ft}	6000
8.	Training	-	10000
9.	Other Miscellaneous	-	1500
10.	Total Cost	-	36800/-

9.2-Cost estimation of Fuselage-

Operation Number: 02 Product: Unmanned Aerial Vehicle
 Operation Name: Fabricated Fuselage Worked on by: _____
 Previous Station: _____ Next Station: _____

Part Name: Fabricated Fuselage
 Part Number: 2 Quantity: 01
 Material or Stock: 7 feet height
 Tools/Equipment: Glue Gun, Grinder, Chapsaw, Hacksaw, Cutter machine, Work bench, Drilling machine.
 Fixtures/Gauges: Zero Surface table

Drawing of Major Details of Operation:

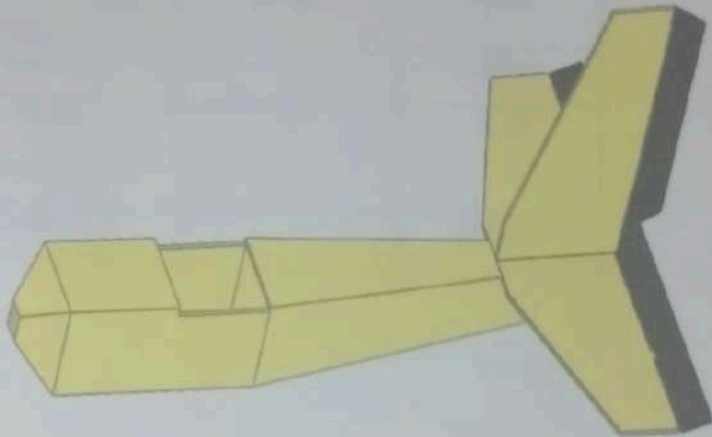

Supplies: Fixture

Step No.	Description of Step	Fixtures or Gauges	Materials	Safety Equipment	Tools and Equipments
1	Polycarbonate Sheet	Cutter	5 mm thickness sheet and 5 *5 feet sheet	Safety glasses, Hand gloves	Measuring tape, Cutter, Glue Gun
2	Fabrication / welding of structure as per diagram & calculation	Glue gun	5 mm thickness sheet and 5 *5 feet sheet	Safetyglasses, Hand gloves	Measuring tape, Glue Gun.

**DESIGN AND FABRICATION OF CATTLE FEED
MAKING MACHINE**

A REPORT SUBMITTED TO

DR. BABASAHEB AMBEDKAR TECHNOLOGICAL UNIVERSITY,
LONERE

IN PARTIAL FULFILLMENT FOR THE DEGREE OF BACHELOR OF
TECHNOLOGY

IN

MECHANICAL ENGINEERING

SUBMITTED BY

MR. ABHISHEK SHASHIKANT HOWALE

MR. PARTH SHRIKANT PATIL

MR. SAGAR NAMDEV LOHAR

MR. ROHAN RAKHAMAJI MODE

UNDER THE GUIDANCE OF

DR. P.P.AWATE



**PADMABHOOSHAN VASANTRAODADA PATIL INSTITUTE OF
TECHNOLOGY, BUDHGAON**

2022-23

Padmabhooshan Vasanthaodada Patil Institute of Technology, Budhgaon.

Department of Mechanical Engineering



CERTIFICATE

This is to certify that the group of students of B. Tech. Mechanical have completed satisfactorily the project. They have submitted project report entitled "**Design and Fabrication of Cattle Feed Making Machine**" in fulfilment of B.Tech. "Mechanical Engineering" affiliated to DBATU, Lonere.

To the best of my knowledge and belief, the matter presented in this project report has not been submitted earlier and is their original work.

Guide

Dr. P.P. Awate

H.D.D

Dr. A.P. Shrotri

Principal

Dr. D. V. Ghevade

Vasantdada Industrial Estate, Sangli. 9049742473

Date:-

To,

H.O.D.

Department of Mechanical Engineering P.V.P.I.T –Budhgaon

Subject:-Sponsorship for the Project work of Undergraduate students of P.V.P.I.T.

Dear Sir,

As per our Memorandum of Understanding we are ready to sponsor your following students for their project work in B.Tech. Mechanical Engineering (Year2022-23).We will provide all the Data and other required assistance for the project work. However the final outcome of the project work shall be the property of our organization. It is mandatory for the students to complete the task as per the commitment.

Name of the students

Sr.	Name of the students	Class	Roll No.
1	Sagar Namdev Lohar	B.Tech.-A	10
2	Rohan Rakhmaji Mode		12
3	Parth Shrikant Patil		14
4	Abhishek Shashikant Howale		17

(Sign & Seal of Director)

ABHISHEK ENTERPRISES,

Proprietor

INDEX

Sr. No.	Title	Page
1.	Abstract	1
2.	Chapter 1	2
3.	1.1 Introduction	2
4.	1.2 Importance	3
5.	1.3 Main Ingridents Of Cattle Feed	4
6.	1.4 Objective	5
7.	Chapter 2	6
8.	2.1 Literature Review	6
9.	Chapter 3	8
10.	3.1 Methodology	8
11.	3.2 Block Diagram	9
12.	Chapter 4	10
13.	4.1 Experimental Setup	10
14.	4.1.1 Brief Specifications Of Parts	10
15.	4.2 Selection of Material and parts	14
16.	4.3 Design	17
17.	4.4 Calculation	19
18.	4.5 Material Analysis	24
19.	Chapter 5	25
20.	5.1 Process Flow Diagram	25
21.	5.2 Manufacturing Process	26
22.	Chapter 6	31
23.	6.1.1 Material Cost	31
24.	6.1.2 Manufacturing Cost	32
25.	Chapter 7	33
26.	Project Photos	33
27.	Chapter 8	36
28.	Conclusion	36
29.	Chapter 9	37
30.	References	37

6.1.2 Manufacturing Costing :

Sr. No.	Manufacturing Process	Cost in Rs.
1	Cutting	500
2	Bending	1000
3	Welding	2500
4	Grinding	400
5	Drilling	1800
6	Machining	1850
7	Keyway	450
8	Tapping	300
	Total	8800

Total Estimate Cost :

Total = Material Cost + Manufacturing Cost

$$= 25989 + 8800$$

$$= 34789$$

CHAPTER 6:

6.1 Costing

6.1.1 Material Costing :

Sr. No	Material	Quantity nos	Cost In Rs
1.	M.S. Plate (3mm, 5mm, 16mm)	3	1612
2.	M.S. Channel (40*40*5mm)	1	473
3.	M.S. Rod (30mm dia.)	1	304
4.	Belt (B-44)	1	200
5.	Motor (2 Hp 3 Phase)	1	10800
6.	Gear Box (5:1)	1	9500
7.	Pulley (B Type)	2	500
8.	Lovejoy Coupling	1	800
9.	Bearing	4	1000
10.	Wire (4 core)	1	300
11.	Colour	1	500
	Total		25989

4.3 3D Model :

1) Iso metric View :

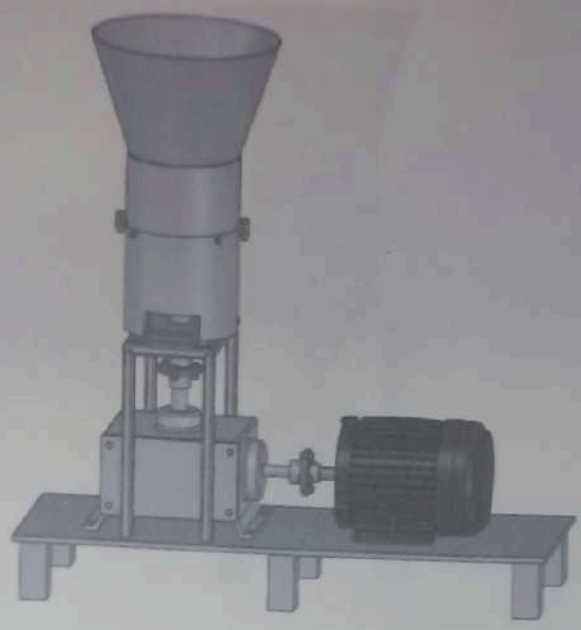

2) FrontView :

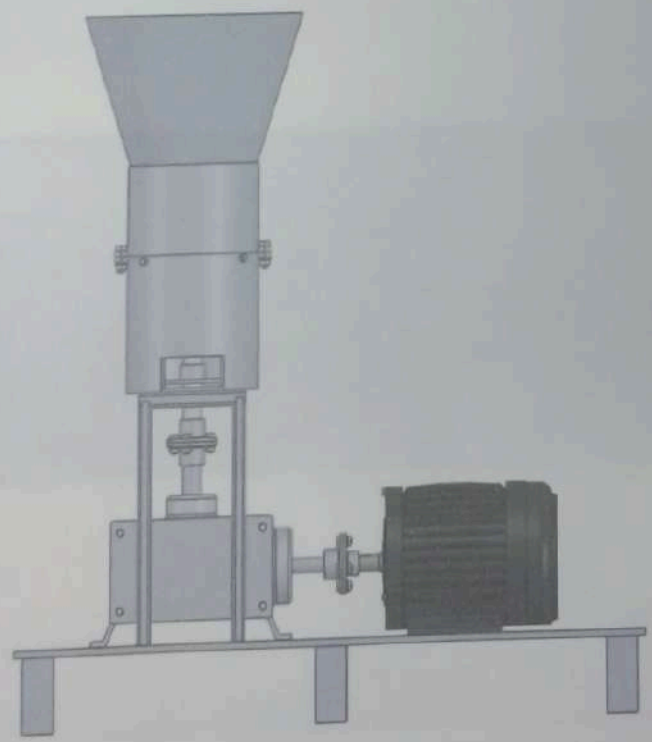



Dimensions:

Bore diameter	30 mm
Contact angle	14.036 °
Outside diameter	62 mm
Width, inner ring	20 mm
Width, outer ring	17 mm
Width, total	21.25 mm

1.1.1 SINGLE ROW DEEP GROOVE BALL BEARING: (6404)

Single row deep groove ball bearings are particularly versatile, have low friction and are optimized for low noise and low vibration, which enables high rotational speeds. They accommodate radial and axial loads in both directions, are easy to mount, and require less maintenance than many other bearing types.

Simple, versatile and robust design

Low friction

High-speed capability

Accommodate radial and axial loads in both directions

Require little maintenance

**"DESIGN AND DEVELOPMENT OF HYDRAULIC
VALVE TEST RIG."**

SUBMITTED TO

**Dr. BABASAHEB AMBEDKAR TECHNOLOGICAL UNIVERSITY,
LONERE**

In Partial Fulfillment for the Degree of

BACHELOR OF TECHNOLOGY

in

Mechanical engineering

SUBMITTED BY

Mr. Parve Kunal Dilip	1962691612086
Mr. Mane Shreyas Vilas	1962691612114
Mr. Pise Varad Madhukar	1962691612080
Mr. Mane Sachin Shridhar	1962691612064

UNDER THE GUIDANCE OF

Prof. S. S. Gunjate



**PADMABHOOSHAN VASANTRAODADA PATIL INSTITUTE OF
TECHNOLOGY, BUDHGAON**

Telefax-0233-2310780
Mobile- 9423868777
8605868777

SWAPNIL INDUSTRIES

MANUFACTURERS AND SUPPLIERS OF SUGAR MACHINERY SPARE PARTS, PUMP & PUMP SPARES SPECIALIST IN ALL TYPE OF CONTROL VALVE REPAIR WORKS, SPARE PARTS, JOB WORKS
Plot No. 168/3/6, Old Budhgaon Road, Laxminagar, (Near V. S. S. K. Ltd.), SANGLI. 416416

TO WHOM IT MAY CONCERN

The following student has completed a project entitled, "Design and Development of Hydraulic Valve testing Rig" for different types of valve testing purposes.

It may be beneficial for further development and career growth in their future.

Roll no	Name	PRN
4129	Parve Kunal Dilip	1962691612086
4132	Mane Shreyas Vilas	1962691612114
4136	Pise Varad Madhukar	1962691612080
4166	Mane Sachin Shridhar	1962691612064

Name of Student

Mr. Parve Kunal Dilip - 1962691612086

Mr. Mane Shreyas Vilas - 1962691612114

Mr. Pise Varad Madhukar - 1962691612080

Mr. Mane Sachin Shridhar - 1962691612064

Yours Faithfully
SWAPNIL INDUSTRIES

Proprietor

CHAPTER 7

COST ESTIMATION

Table No.7.1

Sr. No.	Material Description	Size (mm)	Qty. / Wt.	Amount (Rs)
1	Angle	30*30*4	4 Kg	480
2	C-Channel	35*35*4	2 Kg	300
3	Smaller Pulley	65	1	325
4	Bigger pulley	205	1	1175
5	Motor	1 HP	1	7800
6	Pump Setup	Single acting reciprocating pump and accumulator	1	8325
7	Pressure Gauge	5 inch dial	3	2550
8	Relief Valve	Spring Operated	1	450
9	Ball Valve	0.5 inch	6	1260
10	Belt	-	2	620
11	T-Joint	-	6	96
12	Other Miscellaneous	-	-	850
	Total Cost	-	-	24231/-

Swapnil Engineering Works, Madhavnagar, Sangli



Fig: no.6.6. Various Valves



CHAPTER 5

CONSTRUCTION AND WORKING

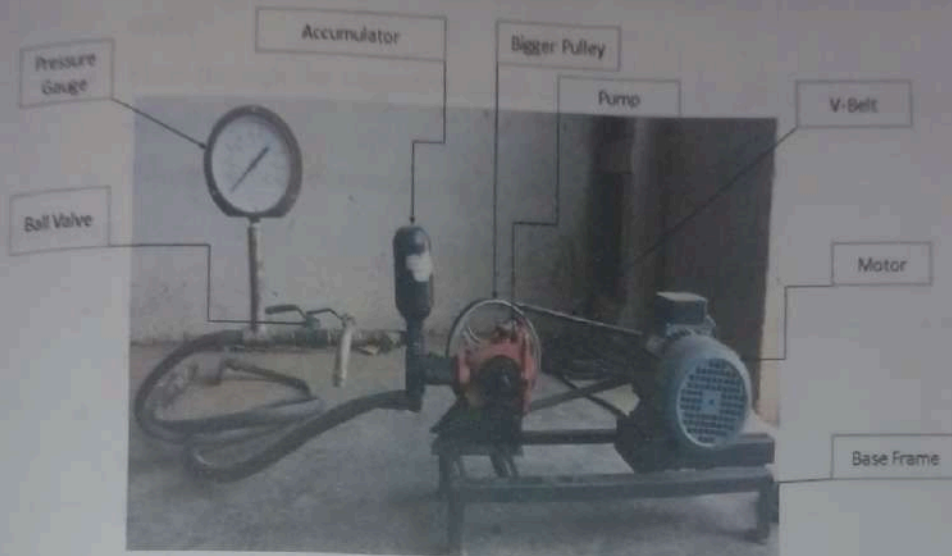

Fig.5.1. Motorized hydraulic valve testing rig

Construction

- Motor is the main part of the setup which is mounted on the base frame which acts as a supportive structure for all the assembly.
- A smaller pulley (diameter 65 mm) is mounted on the motor shaft.
- Motor acts as the main driving unit of the setup.
- Motor is mounted on supportive assembly of C-channels.
- On another end of the base frame a piston pump is mounted.
- Single acting piston pump of (450 rpm) is mounted on the supportive structure.
- A bigger pulley of diameter (205 mm) is mounted on the piston pump.
- Drive from the smaller pulley to the bigger pulley is transferred through a V-belt of 1130 mm length and A-section.

**"DESIGN & DEVELOPMENT OF CATTLE FEED MAKING
MACHINE"**

A Report submitted to
**Dr. BABASAHEB AMBEDKAR TECHNOLOGICAL
UNIVERSITY, LONERE**

in partial fulfillment for the Degree of

BACHELOR OF TECHNOLOGY
in
MECHANICAL ENGINEERING
by

Mr. YADAV GANESH H. (Roll No 37)

Mr. SALUNKHE RUTURAJ D. (Roll No 38)

Mr. PATIL YOGESH Y. (Roll No 39)

Mr. JADHAV ANIKET V. (Roll No 58)

UNDER THE GUIDANCE OF

Mr. P. P. Shinde



**PADMABHOOSHAN VASANTRAODADA PATIL
INSTITUTE OF TECHNOLOGY, BUDHGAON**

2022-23

Sponsorship letter

To,

Mr. Ganesh H. Yadav

Mr. Raturaj D. Salunkhe

Mr. Yogesh Y. Patil

Mr. Aniket V. Jadhav

PADMABHOOSHAN VASANTDADA PATIL INSTITUTE OF TECHNOLOGY (PVPIT)

Subject: - Sponsorship for Design and development of cattle feed making machine.

Hi Team,

We are gone through your idea about making cost effective cattle feed machine, and we reach to the conclusion that this machine will add value to the our business, we can provide quality cattle feed to our farmers, so we declare that we accept your offer to sponsor cattle feed making machine, I am very sure that our team will be grateful to you and will be always there for support and guidance, please continue your good work and all the very best.

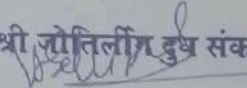
श्री ज्योतिर्लिंग दुध संकलन केंद्र,

Your's faithfully,

प्रोप्रायटर

Dr. Vijay J. Salunkhe

Jyotirling Dudh sankalan Kendr,

Kamlapur

CHAPTER 8

Table No11.1: Project cost and Bill of material

Sr. No	Material	Material of construction	Quantity	Cost per Unit Rs.	Total cost in Rs.
1	Rectangular pipe	Mild steel	02 pair	800	1600
2	Structural frame as per drawing and fabrication labor cost	Mild steel	01	2000	2130
3	1 HP single phase motor	-	01	4000	4000
4	Pulley	Steel	02	300	600
5	Nut and Bolts	High tensile steel			100
6	Belt	Rubber	01	100	100
7	Bearing	As per manufacturers catalogue	01	100	100
8	Die raw material	Mild steel	1	150	150
9	Die fabrication	Mild steel	01	01	100
10	Roller raw material	Aluminium	2	130	260
11	Roller Fabrication	Aluminium	2	100	200
12	Shafts raw material	Mild steel	2	80	160
13	Shaft fabrication	Mild steel	2	100	200
14	Die Housing	Mild steel	1	500	500
16	Pellet out chamber	Mild steel	1	300	300
17	Painting	-	1	1500	1500
18	Welding and assembly labour cost	-	-	-	3000
				Total	15000

Table 8.1 Project cost and bill material

4.3 Pulley Mounting:

The location of the motor shaft on the motor should be chosen based on the machine's design. The motor shaft should be located in a position that is easily accessible for mounting the pulley. The pulley mounting system should be fabricated using a cutting and drilling process. The keyway should be cut to exact specifications, and the set screw or lock nut should be installed in the proper location. The pulley can be installed onto the motor shaft by sliding it onto the shaft, aligning it with the keyway, and tightening the set screw or lock nut. The pulley should be securely mounted to ensure that it does not slip on the motor shaft during operation. The pulley should be aligned with the driven equipment, such as the die of the cattle feed pellets making machine, to ensure that it operates efficiently and with minimal wear. The pulley should be tested to ensure that it is operating properly. This can be done by running the machine and observing the pulley's performance, including its speed, alignment, and vibration.



Fig. 4.3 Pulley mounting

4.4 Belt Mounting:

The belt specifications should be determined before mounting it on the pulley. This includes the belt length, width, and pitch. The pulley should be aligned with the driven equipment to ensure that the belt runs smoothly and with minimal wear. The belt can be installed onto the pulley by placing it around the pulley and ensuring that it is properly seated. The belt should be aligned with the pulley grooves to ensure that it operates smoothly and with minimal wear. The belt tension should be adjusted to ensure that the belt is tight enough to prevent slipping but not so tight that it causes excessive wear on the pulley or the driven equipment. The proper belt tension can be determined by using a tensioning device or by manually adjusting the tension until the belt is properly tensioned. The belt should be tested to ensure that it is

of
BACHELOR DEGREE IN MECHANICAL ENGINEERING

Project on

Design and development of test set up to study hydrodynamic journal
bearing pressure distribution

Submitted By,

Sr. No	NAME of Student	ROLL NO	SIGN
1	Patil Avishkar T.	4106	
2	Nirmale Yash R.	4123	
3	Deshinge Koustubh A.	4128	
4	Patil Mahesh S.	4161	
5	Shintre Piyush K..	4107	
6	Deshpande Rajwardhan R.	4143	
7	Kumbhar Ashish R.	4142	
8	Mane Santosh S.	4146	

Under the guidance of

Prof. K. D. GHATAGE



DEPARTMENT OF MECHANICAL ENGINEERING 2022-2023

INSTITUTE OF TECHNOLOGY, BUDHGAON

DEPARTMENT OF MECHANICAL ENGINEERING

CERTIFICATE





This is Certify That Project Report Of

Design and development of test set up to study hydrodynamic journal bearing pressure distribution

Submitted By,

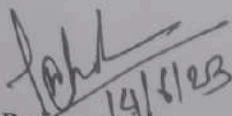
Sr. No	NAME of Student	ROLL NO
1	Patil Avishkar T.	4106
2	Misra Yash R.	4123
3	Deshinge Koustubh A.	4128
4	Patil Mahesh S.	4161
5	Shintre Piyush K..	4107
6	Deshpande Rajwardhan R.	4143
7	Kumbhar Ashish R.	4142
8	Mane Santosh S.	4146

Project guide
Prof. K.D. Ghatage

HOD
Prof. A.P. Shrotri

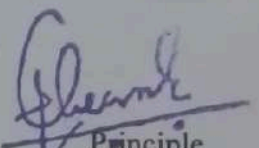
Principle
Dr. D.V. Ghewade



**SUPERSONIC
ELECTRONICS**

M/S Supersonic Electronics,
C-13, M.I.D.C, Miraj, Dist. Sangli, Maharashtra
LL : 07276026913, Mob : 91-9860578762

Date:- 10/3/2023

CERTIFICATE OF SPONSORSHIP

This is to certify that following students of Padmabhooshan Vasantraodada Patil Institute of Technology, Budhgaon, of Mechanical Branch, has successfully completed their project entitled "Design and development of Hydrodynamic Journal Bearing Test Rig" in our company, with reference to the partial fulfillment of the requirements of the Bachelor of Degree Course of Dr. Babasaheb Ambedkar Technological University

NAME	ROLL NO
AVISHKAR PATIL	4106
YASH NIRMALI	4123
KOUSTUBH DESHINGE	4128
MAHESH PATIL	4161
PIYUSH SHINTRE	4107
RAIWARDHAN DESHPANDE	4143
ASHISH KUMBHAR	4142
SANTOSH MANE	4146

All necessary details and economical help were provided from our side for the investment of this project. Project work was started on 05/01/2023 and completed 10/03/2023. We found all have good technical knowledge and skills.

This certificate issued on their personal request only.

We wish them very best in all their future endeavours.

Thanking You,



Yours Faithfully,

FOR SUPER SONIC ELECTRONICS
For Supersonic Electronics
M/s. Supersonic Electronics
C - 13, M. I. D. C
Miraj, 416410, Dist. Sangli,
Maharashtra India



Names of Components	Price
Bearing	15000/-
DC motor	5000/-
Control Unit	8000/-
Manometer panel	10000/-
Tubes	3000/-
Oil	2000/-
Frame	5000/-
Labour charges	5000/-
Transportation Charges	1000/-
GST	10000/-
Total	64000/-

3.7 Design and draftings of components

1. Hydrodynamic journal bearing

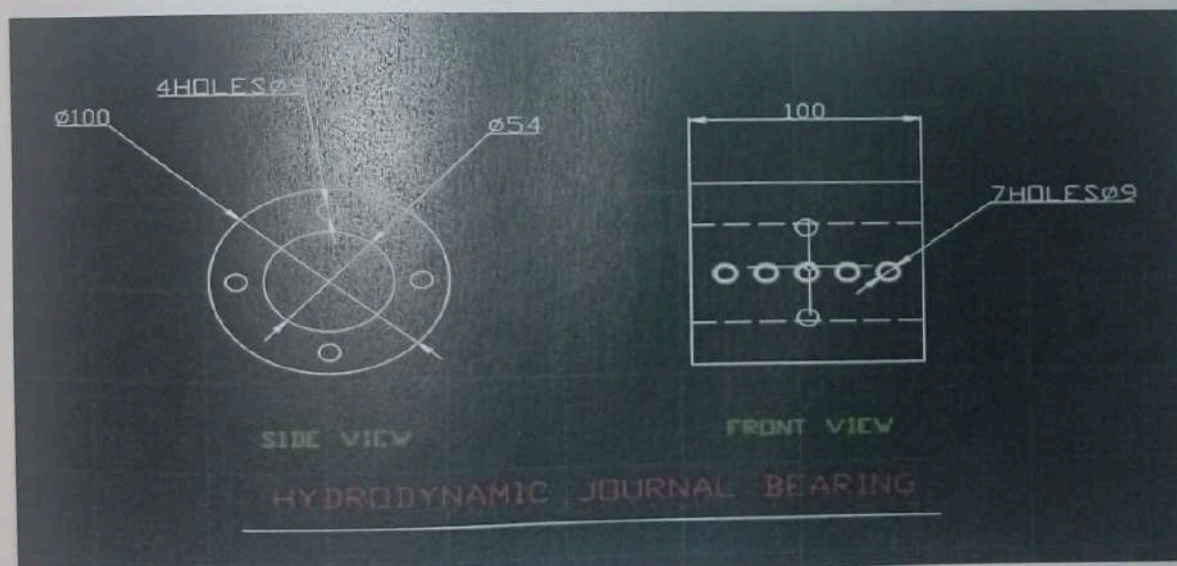

3.1.1 The journal shaft

A shaft is a rotating machine element which is used to transmit power from one place to another. The power is delivered to the shaft by some tangential force and the resultant torque (or twisting moment) set up within the shaft permits the power to be transferred to various machines linked up to the shaft.

Dimensions:

Material	Mild steel
Length of shaft	252mm
Dimeter of shaft	25mm

Construction:



3.1.2 The journal bearing

The journal bearing is designed in such a way that the shaft would be housed within it with one end sealed. The journal bearing would compose of inlet and outlet holes. The inlet

DESIGN & DEVELOPMENT OF PORTABLE ELECTRIC POWER TILLER MACHINE

A Report submitted to

**Dr. BABASAHEB AMBEDKAR TECHNOLOGICAL UNIVERSITY,
LONERE, RAIGAD**

in partial fulfillment for the Degree of
BACHELOR OF TECHNOLOGY

In

Mechanical Engineering

By

Viraj	Viraj Arun Pawar	[4213]
Sanket	Sanket Manik Pawar	[4225]
Nikhil	Nikhil Dilip Patil	[4234]
Rushikesh	Rushikesh Chandrakant Patil	[4242]

Prof . A.S.Patil



**PADMABHOOSHAN VASANTRAODADA PATIL INSTITUTE
OF TECHNOLOGY, BUDHGAON**

2022- 2023



**PADMABHOOSHAN VASANTRAODADA PATIL INSTITUTE OF
TECHNOLOGY, BUDHGAON**

Department of Mechanical Engineering

CERTIFICATE

This is to certify that the project report entitled

Design and Development of Portable Electric Power Tiller Machine

submitted by

Viraj Arun Pawar	[4213]
Sanket Manik Pawar	[4225]
Nikhil Dilip Patil	[4234]
Rushikesh Chandrakant Patil	[4242]

to Dr. BABASAHEB AMBEDKAR TECHNOLOGICAL UNIVERSITY,
LONERE, RAIGAD in partial fulfillment for the award of the degree of **B. Tech
in Mechanical Engineering** is a bona fide record of project work carried out
by him/her under my/our supervision. The contents of this report, in full or in
parts, have not been submitted to any other Institution or University for the
award of any degree or diploma.

Prof. A.S. Patil
Project Guide

Prof. Dr. A. P. Shrotri
Head of Dept.

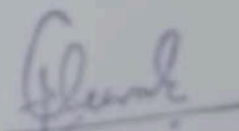
Prof. Dr. D. V. Ghewade
Principle

Plot no D-84 , 5 Star MIDC Kagal 416236

Kolhapur Maharashtra

Contact – 9552586354

Email – valtech.piraji@gmail.com

Web – www.valtechsolution.in

VALTECH

BUILDING SOLUTIONS PVT. LTD.

Build right with expertise

Date:- 11-06-2023

SPONSORSHIP LETTER

To,

Principal,

PVPIT. Budhgaon, Sangli, 416304.

Sub: Permission to work for industry sponsored project.

Dear Sir,

This correspondence is issued as per requirement of following students of your collage.

Name of The Student	Batch- PIB	PRN NO.
Mr. Viraj Arun Pawar -		2062691612085
Mr. Sanket Manik Pawar -		2062691612074
Mr. Nikhil Dilip Patil -		2062691612053
Mr. Rushikesh Chandrakant Patil -		2062691612066

They are interested in fulfilling our company requirements. This initial concept & idea by them are satisfactory for presented company's requirement. Our company is sponsoring the project name is " Design and Development Of Portable Electric Power Tiller Machine ".

We are providing all the technical data & raw material required for project. The cost incurred for the project will be borne by our company & looks Forward for successful completion of the project. Thank you.

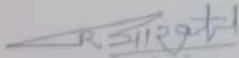

Piraji R. Patil

Executive Director

VALTECH BUILDING SOLUTIONS PVT LTD

KOLHAPUR.

TABLE OF CONTENTS

Sr. No.	Title	Page No.
1.	Chapter No.1. Introduction	6
2.	Chapter No.2. Literature Review	10
3.	Chapter No.3. Problem Defination	12
	3.1 System Flow Diagram	13
	3.2 Solid Works Design	14
4.	Chapter No.4. Design	16
	4.1 Selection Of Materials And Parts	16
5.	Chapter No.5 Ansys Report	23
6.	Chapter No.6 List Of Component	
	6.1 List Of Component	29
	6.2 Cost Estimation of Raw Material	32
7.	Chapter No.7. Weldings	33
	7.1 Gas Welding	33
	7.2 Arc Welding	34
8.	Chapter No.8. lead acid battery	35
9.	Chapter No.9 .Operations	37
	9.1 Fabrication of Tiller	40
10.	Chapter No 10. Working Processes	41
	10.1 Advantages	42
	10.2 Application	42
11.	Chapter No.11 Future Scope	43
12.	Chapter No.12 Testing of Machine	44
12.	Chapter No.12. References	45

CHAPTER NO. 1

INTRODUCTION

Tillage is a basic operation in farming. It is generally done to create a favourable condition for seed placement and plant growth. These operations include ploughing, harrowing and mechanical destruction of weeds and soil crust, [1]. Tillage is the agricultural preparation of soil by mechanical agitation of various types, such as digging, stirring, and overturning. Examples of human-powered tilling methods using hand tools include shoveling, picking, mattock work, hoeing, and raking. Examples of draft-animal-powered or mechanized work include ploughing (overturning with moldboards or chiseling with chisel shanks), rototilling, rolling with cultipackers or other rollers, harrowing, and cultivating with cultivator shanks (teeth).



Fig 1.1 Animal powered tilling operation

Weed removal is one of the post planting operation usually carried out by application of chemicals (herbicides), manual uprooting of the weed and mechanical manipulation of the soil. According to [2] as cited in [3] opined that a farmer using only hand hoe for weeding would find it difficult to escape poverty, since this level of technology tends to perpetuate human drudgery, risk and misery.

The operations involved in the crop production cycle include land clearing, land forming/land leveling, tillage, and crop establishment, harvesting and post-harvest operations. Crop establishment is necessary to eliminate the effect of weeds, pests and disease infestation and to provide suitable conditions for optimum yield [3]. A mechanical device to remove the weeds from an agricultural land is known as weeder. A weeder may be manual or animal drawn and tractor mounted or power operated [4].

COST ESTIMATION OF RAW MATERIAL

SR.NO	RAW MATERIAL	COST
1	M.S.1 INCH 6 M PIPE	580
2	M.S.SHAFT ,BEARING UCP204, ROTOR BLADES	1950
3	SPROCKET,CHAIN,,BUSH	265
4	WHEELS	1290
5	CONTROLLER 48V 750W ,MOTOR 48V 750W	8500
6	LEAD ACID BATTERY	2500
7	NUT,METAL SHEETS	320
	TOTAL COST	15085

COST FOR MANUFACTURING OF MACHINE

SR.NO	MANUFACTURING PROCESS	COST
1	PIPE CUTTING ,BENDING,PRESSING,GRINDING	520
2	SHAFT MACHINING	770
3	PIPE WELDING	125
	TOTAL COST	1415

CHAPTER NO.4 DESIGN AND DETAILS OF COMPONENT

4.1) SELECTION OF MATERIALS

After doing research on the several material properties, the most feasible material is selected for the portable electric tiller and cutter machine. We investigated for the characteristics which are taken into account, which including machinability, durability, strength, weight, availability, and material cost. A material with sufficient strength is chosen to ensure that the frame of the portable electric tiller and cutter machine does not fail under the strain exerted. Circular iron pipe has been used for this project.

Calculation for Designing the Electric Power Tiller Following are the calculation for the designing of the electric power tiller and similarly gets validate with numerical analysis.

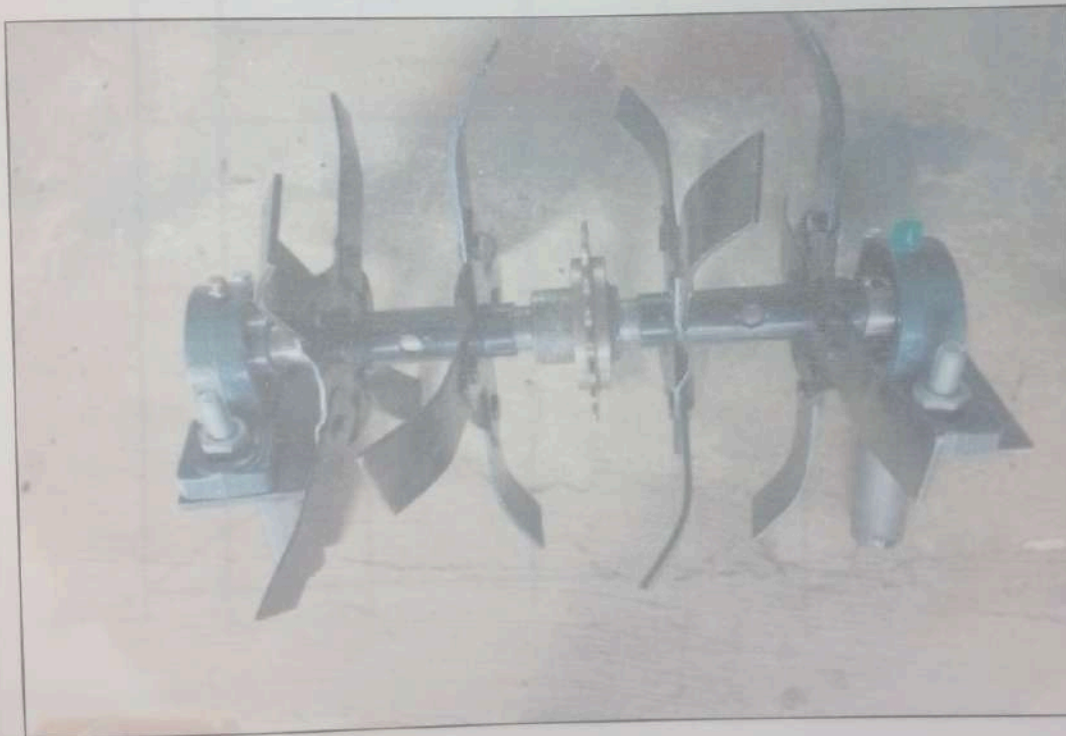

Fig.4.1 Rotor shaft assembly

9.1) FABRICATION OF TILLER



**DESIGN AND DEVELOPMENT OF SOLAR OPERATED
SUNFLOWER SEED SEPARATOR**

A Report submitted to

**DR. BABASAHEB AMBEDKAR TECHNOLOGICAL UNIVERSITY,
LONERE**

in partial fulfillment for the Degree of
BACHELOR OF TECHNOLOGY

in

Mechanical engineering

SUBMITTED BY

Mr. TEJAS A KHOT -	2062691612037
Mr. ANIKET A SHINDE -	2062691612014
Mr. VAIBHAV P MORE -	2062691612105
Mr. PRANAV A KAMBLE-	2062691612075

UNDER THE GUIDANCE OF

Prof. S.J. Advul



**PADMABHOOSHAN VASANTRAODADA PATIL INSTITUTE OF
TECHNOLOGY, BUDHGAON**



**PADMABHOOSHAN VASANTRAODADA PATIL INSTITUTE OF
TECHNOLOGY, BUDHGAON**

Department of Mechanical engineering

CERTIFICATE

This is to certify that the project report entitled

**DESIGN AND DEVELOPMENT OF SOLAR OPERATED
SUNFLOWER SEED SEPARATOR**

submitted by

Name of The Student	PRN NO.
Mr. TEJAS AJITKUMAR KHOT -	2062691612037
Mr. ANIKET AMAR SHINDE-	2062691612014
Mr. VAIBHAV POPAT MORE -	2062691612105
Mr. PRANAV ANANDA KAMBLE-	2062691612075

to Dr. BABASAHEB AMBEDKAR TECHNOLOGICAL UNIVERSITY, LONERE, in partial fulfillment for the award of the degree of **B. Tech in Mechanical engineering** is a *bona fide* record of project work carried out by him/her under my/our supervision. The contents of this report, in full or in parts, have not been submitted to any other Institution or University for the award of any degree or diploma.

Guide

(Prof. S. J. Adsul)

Head of Department

(Prof. A.P. Shrotri)

Principal

(Dr. D.V. Ghewade)



ABHISHEK ENTERPRISE

Plot No.136, Industrial Estate, Sangli - 416 416 (M.S) India

Email : abhishek.sutar004@gmail.com

Mob. No -9049742473

Date

SPONSORSHIP LETTER

To,

Principal,

PVPIT, Budhgaon, Sangli, 416304.

Sub: Permission to work for industry sponsored project.

Dear Sir,

This correspondence is issued as per requirement of following students of your college.

Batch- P4B

Name of The Student

PRN NO.

Mr. Tejas Ajitkumar Khot -

2062691612037

Mr. Aniket Amar Shinde-

2062691612014

Mr. Vaibhav Popat More -

2062691612105

Mr. Pranav Ananda Kumble-

2062691612075

They are interested in fulfilling our company requirements. This initial concept & idea presented by them are satisfactory for company's requirement. Our company is sponsoring the project name is " Design and Development Of Solar Operated Sunflower Seed Separator ".

We are providing all the technical data & raw material required for project. The cost incurred for the project will be borne by our company & looks forward for successful completion of the project. Thank you.

Abhishek A. Sutar

Abhishek Enterprise

ABHISHEK ENTERPRISES,

Abhishek A. Sutar
Proprietor

INDEX

Chapter 01 – Introduction.....	9
Chapter 02 - Problem Definition.....	11
2.1 Need.....	11
2.2 Objective.....	12
2.3 Scope of Work.....	12
Chapter 03- Sunflower Seed.....	13
3.1 Sunflower Seed.....	13
3.2 History and cultivation.....	14
3.3 Use of sunflower.....	15
3.4 Necessity of removing hull from sunflower seed.....	17
3.5 Health Benefits of Sunflower Seeds.....	20
Chapter 04 – Literature Review.....	23
Chapter 05 – Design Methodology.....	28
5.1 Chart.....	28
5.2 List of Components.....	29
Chapter 06 – Design and working of machine.....	40
6.1 Design of machine.....	40
6.2 Working machine.....	41
6.3 Changes done in pilling area.....	41
Chapter 07 – Design Parameters and Calculations.....	44
7.1 Design of Shaft.....	44
7.2 Selection of Bearing.....	46
7.3 Power Calculation.....	48
7.4 Solar Power Supply.....	48
Chapter 08 – Future Scope.....	49
8.1 Future Scope.....	49
8.2 Proposed Business Idea.....	49
Chapter 09 – Cost Estimation.....	50
9.1 Material Cost.....	50
9.2 Manufacturing Cost.....	51
Chapter 10 – Conclusion.....	52
Chapter 11 - References.....	53



Chapter No.9

Cost Estimation

9.1 Material cost:-

Sr. no.	Components	Cost(Rs)
1.	Hollow pipe	1000/-
2.	Shaft	600/-
3.	Bearing	1000/-
4.	Bar	450/-
5.	Bushing	600/-
6.	Motor	4500/-
7.	M.S sheet	1560/-
8.	Nut and bolts	65/-
	Total	9775/-

9.2 Manufacturing cost:-

SR.NO.	MANUFACTURING PROCESS	COST [IN Rs.]
01	Cutting	600/-
02	Welding	2000/-
03	Grinding	600/-
04	Drilling	500/-
05	Painting	800
06	Machining (lathe)	1000/-
	Total	5500/-

Signs that a wiper motor is about to fail include slow or intermittent operation, wipers that will operate at only one speed, or arms that stop in the middle of the windshield when turned off. If your wipers don't work, the fault could also lie with other parts of the wiper system. In the winter, for example, trying to use the wipers when the blades are stuck to the windshield because of ice or snow can blow the fuse for the motor or trip a circuit breaker. Other possible causes are the interior switch that controls the wipers failing, wires in the system being damaged, or the linkage that pushes and pulls the wiper arms breaking. Moving parts in the linkage may also be stuck from corrosion and/or gunk and need lubrication.

5. Blower Motor/Fan



Fig no. 5.2.5 blower fan

A fan is a powered machine used to create a flow of air. A fan consists of a rotating arrangement of vanes or blades, generally made of wood, plastic, or metal, which act on the air. The rotating assembly of blades and hub is known as an impeller, rotor, or runner. primarily, both fans and blowers are used for cooling and air circulation either in indoor areas, HVAC systems, or inside industrial machines as well as electronic equipment. Ironically, the term blower fan is also quite widely used, especially when it comes to industrial blower fan. Industrial blower fan is used to induce gas flow through ducting from an industrial setup to out in the open air. Depending on the flow needed, blower fans are needed for exhaustion,

EFFECT OF PRE-TREATMENT ON KITCHEN WASTE AND BIOGAS PURIFICATION

A Project report submitted in partial fulfillment of requirements for the
award of Degree of

B. Tech (Mechanical Engineering),

DBATU Lonere

SUBMITTED BY

SR. NO	NAME OF STUDENTS	PRN NO.
1)	MR. SANKET RAOSAHEB UPADHYE	2062691612047
2)	MR. ROHIT RAVINDRA JADHAV	2062691612021
3)	MR. VISHAL SANJAY BANSODE	2062691612046
4)	MR. SHANTANU SANJAY PATIL	2062691612044



UNDER THE GUIDANCE OF

Prof. C. D. Patil

**DEPARTMENT OF MECHANICAL ENGINEERING
PADMABHOOSHAN VASANTRAODADA PATIL INSTITUTE
OF TECHNOLOGY, BUDHGAON 416304**

DR. VASANTRAODADAPATILSHETKARI SHIKSHAN MANDAL'S
PADMABHOOSHAN VASANTRAODADA PATIL INSTITUTE
OF TECHNOLOGY, BUDHGAON 416304

CERTIFICATE



This is to certify that the seminar report on Effect of Pre-treatment on Kitchen waste And Biogas Purification Submitted By

SR. NO	NAME OF STUDENTS	PRN NO.
1)	MR. SANKET RAOSAHEB UPADHYE	2062691612047
2)	MR. ROHIT RAVINDRA JADHAV	2062691612021
3)	MR. VISHAL SANJAY BANSODE	2062691612046
4)	MR. SHANTANU SANJAY PATIL	2062691612044

Class B. Tech (Mechanical Engineering), Division B, Semester VIII 2022-23 is bonafied work carried out by his in partial fulfillment of the requirements for the award of B. Tech in Mechanical Engineering by DBATU, Lonere.

Guide

(Prof. C. D. Patil)

HOD

(Dr. A. R. Shrotri)

(Dr. D. V. Ghewade)



SANGEETA INDUSTRIES

575/10, behind Win win Industries,
Shiroli MIDC, Kolhapur,
Tal-Hatkanangale, Dist-Kolhapur, 416122.
Contact no.9970575350
Email:sangeetaindul@gmail.com
GST No.27BFXPG1413A1ZS

Date :- 19 Sep 2022

LETTER FOR SPONSORSHIP: PROJECT WORK

To,
The HOD (Mech) /Principal,
PVPIT,
Budhgaon.

Subject:-Sponsorship for project work

Dear Sir,

This is to confirm that sponsorship for following project is the academic interest of your following pursuing B.Tech. Mechanical with tentative title for dissertation work "EFFECT OF PRE-TREATMENT ON KITCHEN WASTE AND BIOGAS PURIFICATION" The Project Sponsored amount is Rs.15,750 sanctioned.

Sr. No.	Name of students
1.	Mr. SANKET RAOSAHEB UPADHYE.
2.	Mr. ROHIT RAVINDRA JADHAV.
3.	Mr. VISHAL SANJAY BANSODE.
4.	Mr. SHANTANU SANJAY PATIL.

- The project work is being issued in the academic interest of your students with the following terms and conditions.
- The student would need to arrange his own transport to and from the institution.
- The access to the premise/office is sub to terms and conditions governed by limited access policy of the client.
- The project work is expected to be completed by 30 may 2023.

Thank you,

Regards,

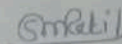

(Authorised signature)

EFFECT OF PRE-TREATMENT ON KITCHEN WASTE AND BIOGAS PURIFICATION

Annexture



APEX INNOVATIONS PVT. LTD.

Test Report

Sample Name	Without Filtration Bio-Gas and With Filtration Bio-Gas		
Sample No	S290-S291	25.05.2023	
Sample by	Sanket Upadhye, Rohit Jadhav, Vishal Bansode, Shantanu Patil		
Guide	Prof. C. D. Patil		
Research Center	Padmabhooshan Vasantodada Patil Institute of Technology Sangli - Tasgaon Rd, Budhgaon, Maharashtra		

Sample/ Properties	Trial	Sample 1: Without Filtration Bio-Gas				Sample 2: With Filtration Bio-Gas			
		1	2	3	Avg.	1	2	3	Avg.
HC	ppm	2700	2720	2730	2717	1069	1022	1022	1037
CO ₂	% Vol	8.20	8.20	8.40	8.26	2.60	2.40	2.30	2.43
O ₂	% Vol	15.76	15.71	15.67	15.71	19.55	19.58	19.58	19.57
CO	% Vol	0	0	0	0	0	0	0	0
NO _x	ppm	0	0	0	0	0	0	0	0

For Apex Innovations Pvt Ltd

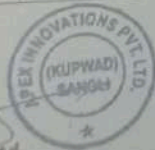

CHAPTER NO.9
COST ESTIMATION

SR NO	COMPONENT	COST (RS)
1)	Digester	1500
2)	Pre-treatment Mechanism	2500
3)	PVC	2500
4)	Gas Pipe	1500
5)	Valve	1000
6)	H ₂ S Scrubber	500
7)	Bubbler	500
8)	Assembly Material	300
9)	Sealing Material	3000
10)	Gas Storage	1600
11)	Paint	350
12)	Holding Stand	500
13)	Gas Testing	1000
	Total	16,750/-

EFFECT OF PRE-TREATMENT ON KITCHEN WASTE AND BIOGAS PURIFICATION

5.3. RESULT IMAGES -



Fig.5.1 Gas Testing Machine Setup (AVL 437 Smoke meter Control Unit)

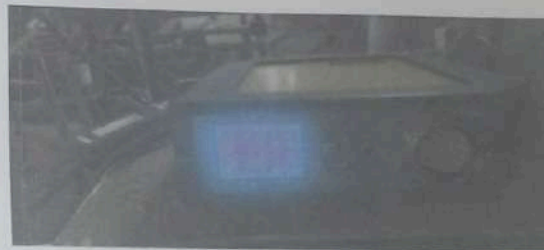

Fig.5.2. Reading Without Filter

Fig.5.3. Reading With Filter

CHAPTER NO.3

THEORY

3.1. TYPES OF BIOGAS DIGESTERS ACCORDING TO -

3.1.1. FIXED DOME TYPE DIGESTER -

The fixed dome consists of an air-tight container or fermentation chamber (constructed of stone and concrete), feed the digestive pipes and a fixed dome on the top for biogas storage. The reaction and biogas storage chambers are connected. Sealing is achieved by building up several layers of mortar on the digester's inner surface. The design of fixed dome type biogas digester originated in Jiangsu, China, as early as 1936.

First fixed-dome design in India was named as JANATA MODEL which could not become successful because of construction problems (gas leakage) and so become absolute. Then came its successor, DEENBANDHU MODEL (2000) with improved design and consumed less building material.

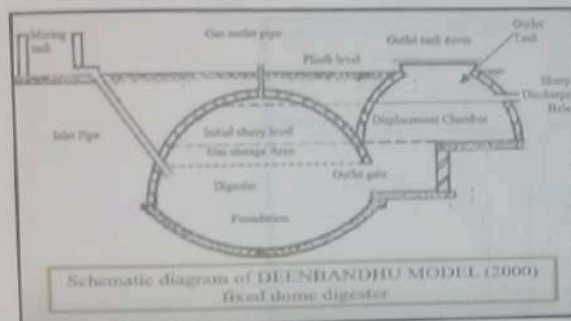

Fig 3.1. Deenbandhu model

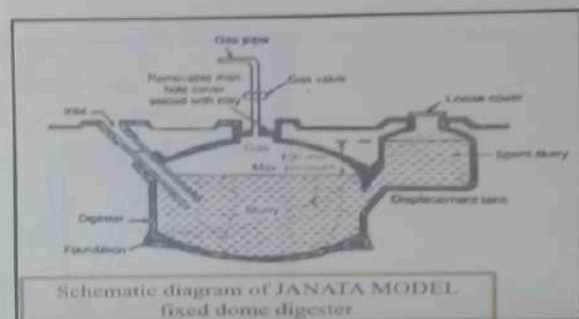

Fig 3.2. Janata model

ADVANTAGES:

- Low initial costs.
- Long useful life-span ($>=20$ years).
- Low construction costs.
- Requires less space.

**Optimization of wire electrical discharge machining
(WEDM) parameters for surface finish (SR) & material
removal rate (MRR)**

A Report submitted to

**Dr. BABASAHEB AMBEDKAR TECHNOLOGICAL UNIVERSITY,
LONERE, RAIGAD**

in partial fulfilment for the Degree of

BACHELOR OF TECHNOLOGY

In

Mechanical Engineering

By

- | | |
|---------------------------|---------------|
| 1. Pathan Rukaiyya Shakil | Roll No. 4308 |
| 2. Pawar Shubham Tanaji | Roll No. 4321 |
| 3. Kamble Pramod Vasant | Roll No. 4326 |
| 4. Patil Sahil Anil | Roll No. 4327 |

**Project Guide
Prof. N. D. Patil**



**PADMABHOOSHAN VASANTRAODADA PATIL INSTITUTE
OF TECHNOLOGY, BUDHGAON**

2022- 2023

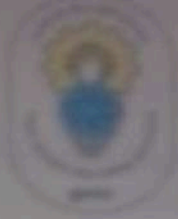

**PADMABHOOSHAN VASANTGADADA PATIL INSTITUTE OF
TECHNOLOGY, BUDHGAON**

Department of Mechanical Engineering

CERTIFICATE

This is to certify that the project report entitled
"Optimization of wire electrical discharge machining (WEDM) parameters
for surface finish (SR) & material removal rate (MRR)"

Submitted By

- | | |
|---------------------------|---------------|
| 1. Pathan Rakhiyya Shakil | Roll No. 4308 |
| 2. Pawar Shubham Tanaji | Roll No. 4321 |
| 3. Kamble Pramod Vasant | Roll No. 4326 |
| 4. Patil Sahil Anil | Roll No. 4327 |

to Dr. BABASAHEB AMBEDKAR TECHNOLOGICAL UNIVERSITY,
LONERE, RAGDAD in partial fulfillment for the award of the degree of B. Tech
in Mechanical Engineering, is a bona fide record of project work carried out by
him/her under my/our supervision. The contents of this report, in full or in parts,
have not been submitted to any other Institution or University for the award of
any degree.

Prof. N. D. Patil
Project Guide

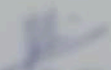
Prof. Dr. A. P. Shrivastava
Head of Department

Prof. U. S. Ghewade
Principal



V. M. INDUSTRIES

(A Manufacturing ,Training & Consulting Division)

Address : H-3, Near Patel Petro Pump, M.I.D.C. Gokul Shirgaon, Kolhapur - 416 234
Mob : 7387808018 / 9588672913 / 7875860400
Email: vm.industrieskop@gmail.com

Ref : 00J701

Date : 31/05/2023

To,
The Principal,
Padmabhooshan Vasantraodada Patil Institute Of Technology, Budhgaon.
Subject : Regarding sponsorship For B. E Student project.

Respected Sir,

With Reference to above subject we are pleased to inform you that our company has taken decision to sponsor project for final year Mechanical Engineering student mentioned below. The Topics of project is "OPTIMIZATION OF WIRE ELECTRICAL DISCHARGE MACHINIG FOR PARAMETERS SUCH AS SURFACE FINISH (SR) & MATERIAL REMOVAL RATE (MRR).

NAME	PRN
1. Kamble Pramod Vasant	2062691612079
2. Patil Sahil Anil	2062691612077
3. Pawar Shubham Tanaji	2062691612094
4. Pathan Rukaiyya Shakil	2062691612023

This will increase techno academic interaction between our organization and your institute. We would like clarify that all technical information, data, required and guidance related to above project will be provided by our company.

Thanking You!



Yours Faithfully,
Mr. D. Mane
(CEO V M Industries)

TABLE OF CONTENTS

Sr. No.	Title	Page No.
1	Chapter No.1. Introduction	1
2	Chapter No.2. Literature Review	24
3	Chapter No.3. Design of Experiment	29
	3.1 Introduction to Process Parameters	30
	3.2 Process Parameters	30
	3.3 Response Variables	32
	3.4 Methodology	32
	3.5 Design of Experiment	33
	3.6 Taguchi DOE	37
4	Chapter No.4. Experimentation	42
	4.1 WEDM	43
	4.2 Major Components of WEDM	45
	4.3 Types of wires	48
	4.4 Selection of Workpiece Material	49
	4.5 Selection of Electrode Material	50
	4.6 Machining Characteristic	51
	4.9 Experimental Result Analysis	56
5	Chapter No.5 Taguchi Analysis	57
6	Chapter No.6 Confirmation Experiment	63
	6.1 Calculations	65
7	Chapter No.7. Result and Discussion	67
8	Chapter No.8. Conclusion	72
9	Chapter No.9 .Future Scope	75
12	Chapter No.12. References	77

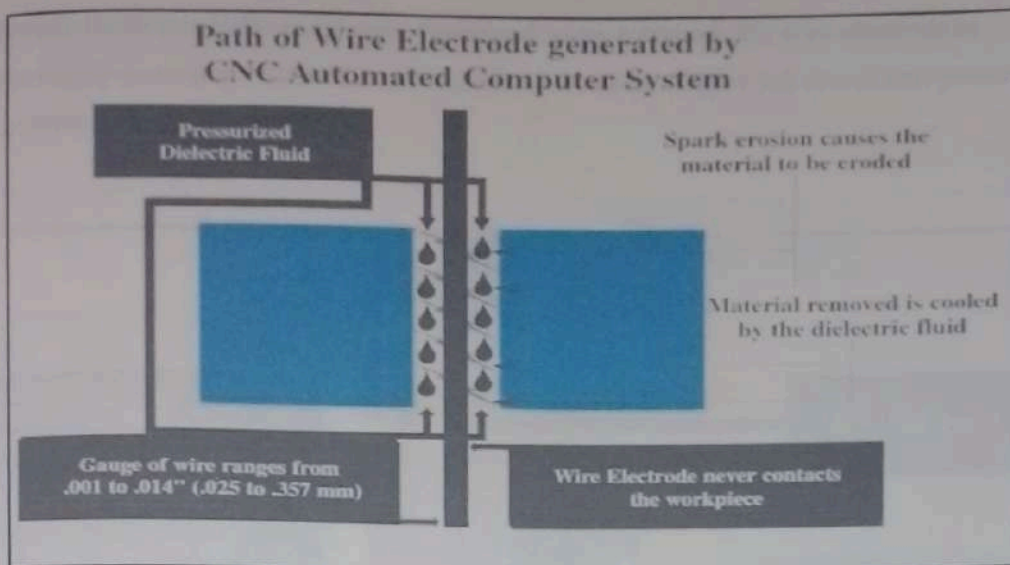

Figure 1.5 Path of wire in WEDM

A DC or AC servo system maintains a gap from .002 to .003" (.051 to .076 mm) between the wire electrode and the work piece. The servo mechanism prevents the wire electrode from shorting out against the work piece and advances the machine as it cuts the desired shape. Because the wire never touches the work piece, wire EDM is a stress-free cutting operation.

1.6.1 Steps involved in Wire EDM process :

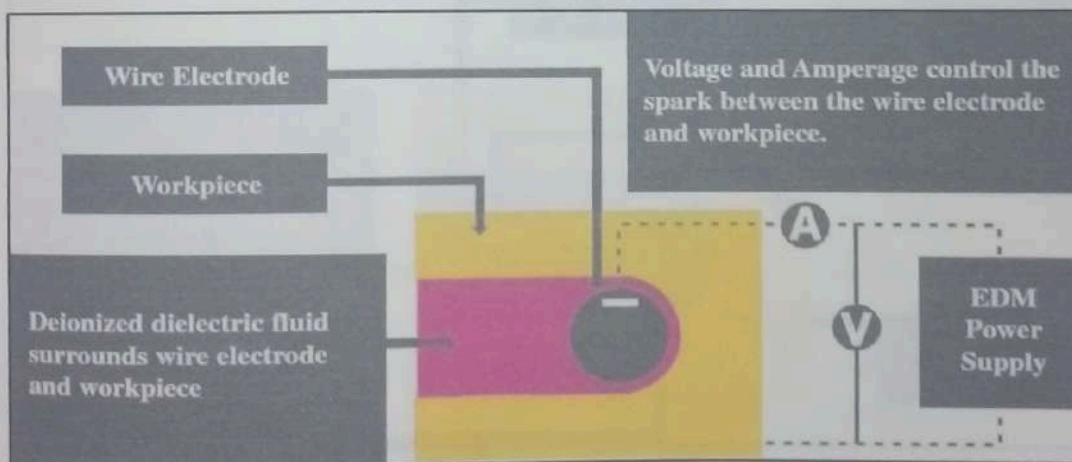

Figure 1.6 Power generation in WEDM

6.1 Calculations

The Calculations for The % increase and % Decrease in SR and MRR-

6.1.1 FOR SR Optimum Parameters

(Compared with Experiment No.3 best for Surface Roughness)

$$\begin{aligned} \% \text{Decrease in SR} &= \frac{(\text{Initial Roughness Value} - \text{Final Roughness Value})}{(\text{Initial Roughness Value})} \times 100 \\ &= \frac{(2.144 - 1.818)}{(2.144)} \times 100 \\ &= 15.20\% \end{aligned}$$

$$\begin{aligned} \% \text{Increase in MRR} &= \frac{(\text{Final MRR} - \text{Initial MRR})}{(\text{Initial MRR})} \times 100 \\ &= \frac{(21.1268 - 21.0872)}{(21.1268)} \times 100 \\ &= 0.18\% \end{aligned}$$

6.1.2 FOR MRR Optimum Parameters

(Compared with Experiment No.7 best for Material Removal Rate

$$\begin{aligned} \% \text{Increase in MRR} &= \frac{(\text{Final MRR} - \text{Initial MRR})}{(\text{Initial MRR})} \times 100 \\ &= \frac{(21.1268 - 21.0872)}{(21.1268)} \times 100 \\ &= 12.86\% \end{aligned}$$

**“DESIGN & DEVELOPMENT OF SEMI-AUTOMATIC JIGS AND
FIXTURES”**

A Report submitted to

**Dr. BABASAHEB AMBEDKAR TECHNOLOGICAL
UNIVERSITY, LONERE**

in partial fulfillment for the Degree of

**BACHELOR OF TECHNOLOGY
in
MECHANICAL ENGINEERING
by**

Mr.Tapase Amit V. (Roll No 09)

Mr.Bhurke Nishant U. (Roll No 10)

Mr.Awati Sushant M. (Roll No.11)

Mr.Deshpande Kartik G. (Roll No 24)

UNDER THE GUIDANCE OF

Mr.P.P.Shinde



**PADMABHOOSHAN VASANTRAODADA PATIL
INSTITUTE OF TECHNOLOGY, BUDHGAON**

2022-23

PADMABHOOSHAN VASANTRAODADA PATIL
INSTITUTE OF TECHNOLOGY, BUDHGAON

Department of Mechanical Engineering



CERTIFICATE

This is to certify that the project report entitled "DESIGN & DEVELOPMENT OF SEMI-AUTOMATIC JIGS AND FIXTURES" submitted by Mr. Tapase Amit V. (Roll No 09), Mr. Bhurke Nishant U. (Roll No.10), Mr. Awati Sushant M. (Roll No.11), Mr. Deshpande Kartik G. (Roll No. 24) to Dr. BABASAHEB AMBEDKAR TECHNOLOGICAL UNIVERSITY, LONERE, in partial fulfillment for the award of the degree of B. Tech in Mechanical Engineering is a bona fide record of project work carried out by him/her under my/our supervision. The contents of this report, in full or in parts, have not been submitted to any other Institution or University for the award of any degree or diploma.

Mr. P.P. Shinde
Guide

Dr. A.P. Shrotri
Head of Department

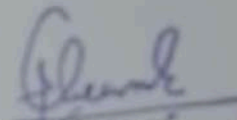
Dr. D.V. Ghevade
Principal

Date: 13/06/23
Place: Budhgaon

CERTIFICATE

This certify that Mr. Amit Vishwanath Tapase, Mr. Nishant Umesh Bhurke, Mr. Sushant Mahadev Awati, Mr. Kartik Girish Deshpande the students of Padmabhooshan Vasantryadada Patil Institute of Technology, Sangli .Currently pursuing their Bachelor of Technology (Mechanical Engineering) have successfully undergone a project of "**Design & Development Of semi-Automatic Jig and Fixture**" in our organization during the academic year 2022-23. They were punctual during the tenure of their project work.

We wish them all the success in their future assignments.

Thanking you,
New Sai Fiber's

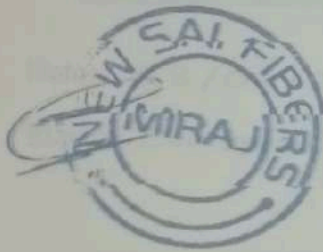

Mr. Shriram Mali

Contents

Chapter No.	Description	Page No.
1	Introduction	01
1.1	Introduction About Company	02
2	Literature Review	04
2.1	Problem Definition	06
2.2	Objectives	07
3	Theory	08
3.1	Theoretical background	08
3.2	Methodology	13
4	Proposed work In Project	15
4.1	Method Study Procedure	15
4.2	Standard Time Calculations Based on PMTS Ideal Condition	16
5	Design of Project	17
5.1	Genral Procedure for Project we are adopted	17
5.2	Component used in our Design Model	20
5.3	Material used for each component	22
5.4	Design Consideration for Jig and Fixture	26
5.5	Factors to consider for the design	27
5.6	Problems encountered and solutions	28
5.7	Pneumatic Connections	29
6	Construction And Working	30
6.1	Construction	30
6.2	Modelling Design in 2D – 3D	33
6.3	Top Design	35
6.4	Jig Design	36
6.5	Shaft Design	37
6.6	Raw Materials Selections	38
6.7	Bottom Design	39

CHAPTER 11

COST OF PROJECT

SR NO	WORKDONE	COST
1	All Bottom Material(EN8+SHAFT+GUN METAL)	2200
2	Manufacturing	8600
3	TOP PISTON	2400
4	PUNCHING TOOL	1000
5	ALL TYPE OF NUT AND BOLT AND EXTRA WORK	1000
6	CONNECTORES PIPES	500
7	CONNECTORS	200
8	BOTTOM PISTON	3200
9	5*3 DCV *2	1600
10	CONNECTORS	200
	Total	20900

Table 11.1 Cost of Project

• **Bottom Mounting:**

To mount the 2 fixed blocks & one center block on the plate each block has been welded with a pair of 30 mm shaft with a 10.5 mm through hole drilled along the axis of the cross-section of shaft. Now these blocks are assembled with the plate using M10 bolts.

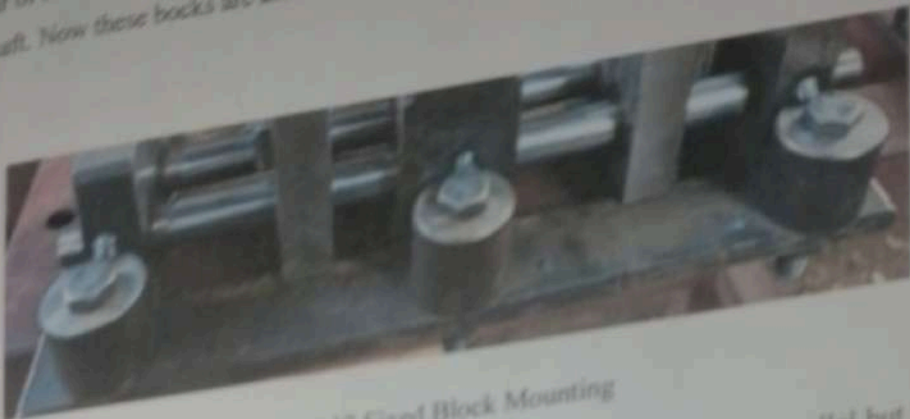

Fig 6.12 Fixed Block Mounting

To transfer the motion to the moving block from the piston in which have parallel but offset of 80 mm two plates are welded to the moving block and are provided with hole of 13 mm in order to bolt the piston rod on this plate with help of M12 Allen bolt.

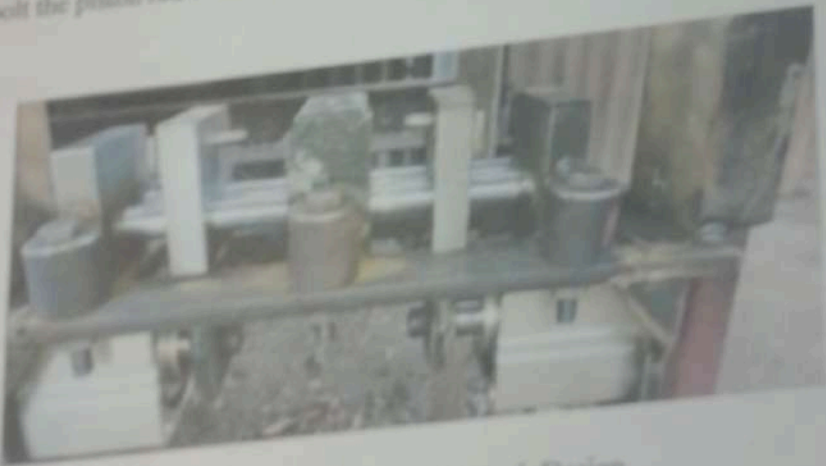

Fig. 6.13 Side View Of Block Design